

VIK-01 IP Video Intercom KIT Quick Installation Guide



i504W
SIP Indoor Station



i60
Video Door Phone



① Package Contents

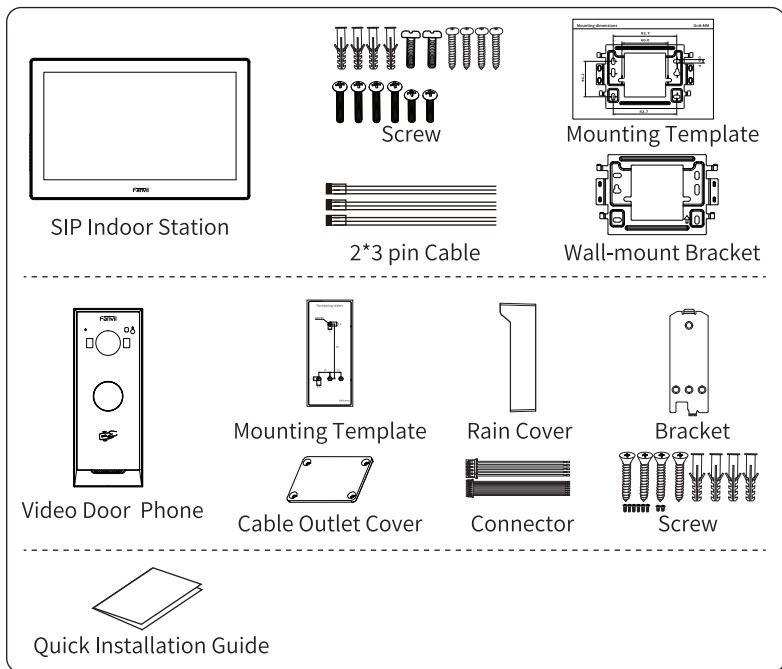

② Product appearance description

1) Panel

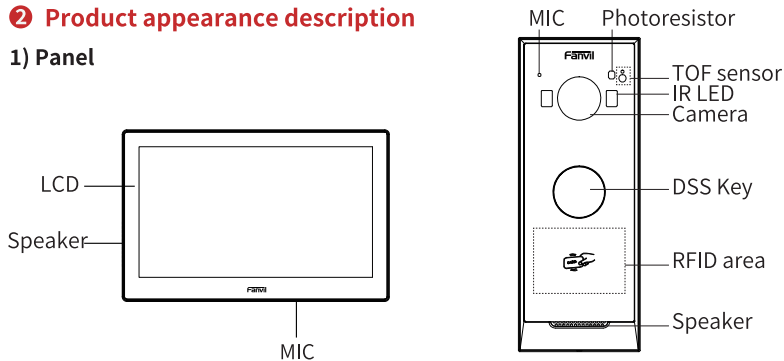

2) Interface description

Indoor Station

There are some interfaces on the back of the device for connecting power supply, alarms etc. The connections are as follows:

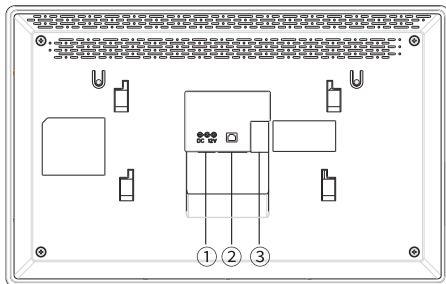

No.	Description	Interface
①	Power interface: 12V/1A input.	
②	Ethernet interface: standard RJ45 interface, 10/100M adaptive, it is recommended to use CAT5 or CAT5E network cable.	
③-1	Power interface: 12V/1A input.	
③-2	1 sets of doorbell interfaces.	
③-3	1 sets of short-circuit output interfaces: corresponding to the short-circuit input interface, login device webpage settings, can be connected to electric locks, alarms etc.	
③-4	8 sets of alarm input interfaces: input devices for connecting switches, infrared sensor, door sensor, vibration sensors etc.	
③-5	1 sets of RS485 interfaces: can be connected to card reader, sensor etc.	

Video Door Phone

1. Interface description

Open the rear case of the device, there is a row of terminal blocks for connecting the power supply, electric lock control, etc. The connection is as follows:

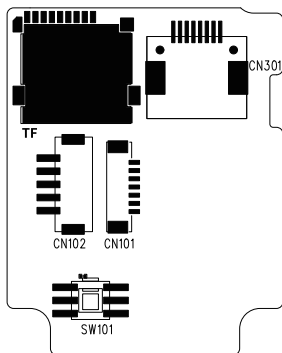

Terminal Block	Name	Wire Color	Description
CN101	DOORA	Red	Two sets of short-circuit input detection interfaces: for connecting switches, infrared probes, door magnets, vibration sensors and other input devices
	GND	Black	
	DOORB	Brown	
	GND	Black	
	WG_D1	Yellow	Wiegand interface
	WG_D0	White	
	GND	Black	
CN102	12V+	Red	Power interface: 12V/1A input up positive, down grounded
	GND	Black	
	NC	Yellow	Short-circuit output control interface: used to control electric locks, alarms, etc.
	COM	Green	
	NO	White	
CN301	Ethernet	/	Ethernet interface: standard RJ45 interface, 10/100M adaptive, it is recommended to use Cat5, Cat5e or Cat6
SW101	Tamper Switch	/	Normally in the pressed state
TF	TF Card Slot	/	Insert TF card here

2. Wiring Instructions

NO: Normally Open Contact;

COM: Common Contact;

NC: Normally Close Contact.

Driving Mode	Electric-lock Mode		Connections
Passive	No electricity when open	Electrify when open	
✓	✓		<p>Electric lock drive (external power supply) Access control power input</p> <p>Indoor switch Electric lock (NO: normally open) Power off and open the door</p>
✓		✓	<p>Electric lock drive (external power supply) Access control power input</p> <p>Indoor switch Electric lock (NC: normally closed) Power on and open the door</p>
✓	✓		<p>External Power Supply (12V) Access control power input</p> <p>Indoor switch</p>

3) Typical Application

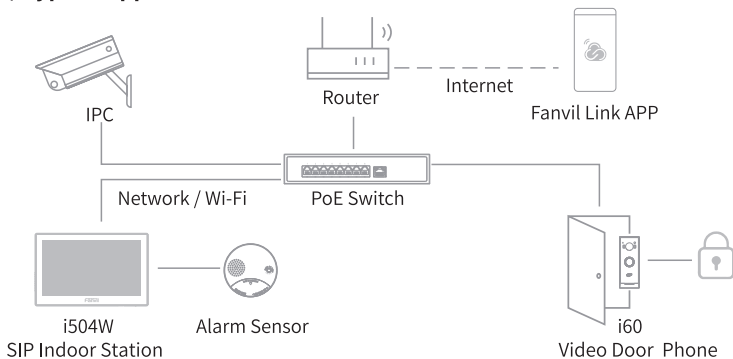

3 Installation

Install SIP Indoor Station

Model 1. Wall-mounted Installation(CN: 86 embedded box,US: single gang&Dual gang, EUR: 80 embedded box)

Step 1: Install wall bracket

Without embedded box in the wall

- Mark four fixation holes positions on the wall with the wall bracket.
- Take down the bracket, using an electric drill to make the four fixation holes on the wall, then insert the four screw fixing seats provided.
- Fix the wall bracket on the wall with four TA4X30 screws.

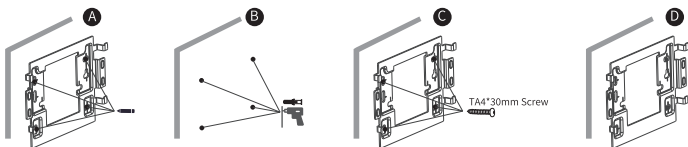

With 86 embedded box in the wall

- Fix the wall bracket on the 86 embedded box with two PM4X16 screws.

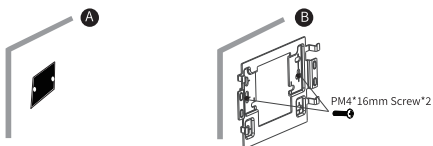

Step 2: Connect peripherals

- If you need to connect other input and output devices, please connect to the host through the cable.

Step 3: Power on the device

If it is working properly, align the slot on the rear side of the panel with the pin on the wall bracket and slide the host down to complete the installation.

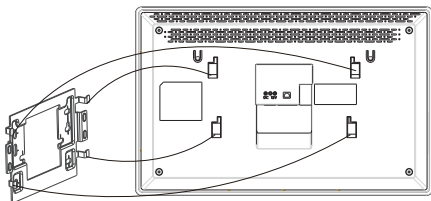

Install Video Door Phone

Notice

Do not install the device in places with condensation, high temperature, grease, or dust.

Install the unit at a suitable visual height, with a recommended height of 120~140cm. If it is installed indoors, please maintain a distance of at least 2 meters from light sources and at least 3 meters from doors and windows to avoid direct sunlight. Avoid violent vibration, collision and impact, which may cause damage to the internal precision.

Step 1: Drill and Install wall bracket

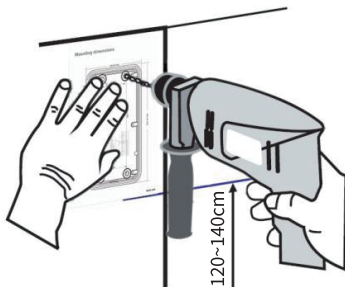

- A. Use the mounting template to mark the exact position of the mounting holes on the wall.
- B. Before marking the holes, use a spirit level or other method to verify that the template is horizontally aligned, this will ensure that the intercom unit will be mounted straight.
- C. Choose the appropriate drill bit and drill the holes at the marked positions, ensure the depth of the holes are 2cm.
- D. Insert the wall anchors into the holes, gently tap the anchors into the holes with hammer until they are flush with the wall surface.
- E. Position the mounting bracket over the drilled holes, ensure the holes on the bracket align with the anchors.
- F. Use the screws to attach the bracket to the wall, tighten the screws with a screwdriver or drill with a screwdriver bit.

Step 2: Connect wiring

A. Connect the CAT5e cable, Power cable, Maglock cables into the slot, tighten the waterproof cover with the KM2*6 screws.

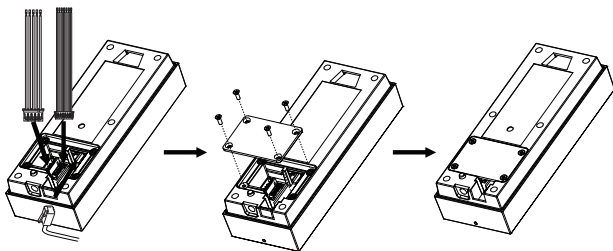

B. If the cable outlet is too small, use diagonal pliers to cut off the cable outlet.

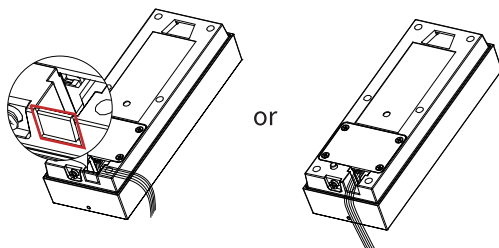

C. Place the unit from bottom to top, position the unit on the mounting bracket, use the screw to tight the unit on the bottom of bracket.

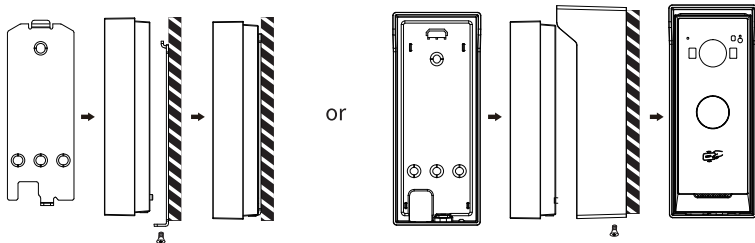

Wall-mounted installation

Rain cover installation

4 Quick Operation

1. Set The Language and Time Zone.

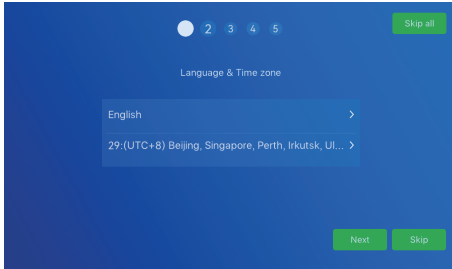

2. Network Settings
2.1 WiFi Settings

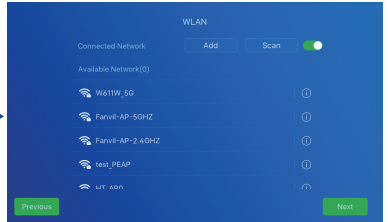
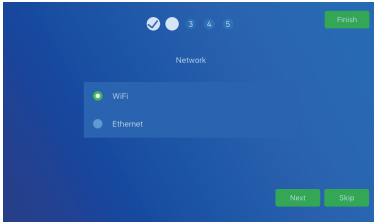

Enable the device Wi-Fi function, and select Wi-Fi. Enter the Wi-Fi's password.

2.2 Ethernet Settings

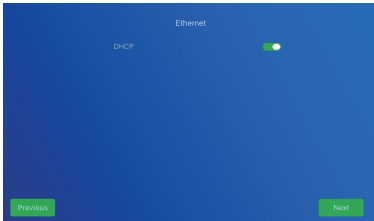

DHCP Settings

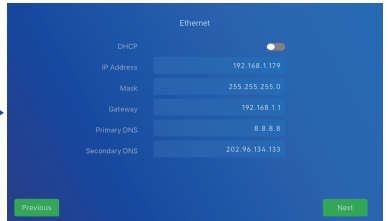

Static IP Settings

Set Ethernet:

DHCP: Enable Auto Get IP Address and the device will be assigned network parameters automatically.

Static IP: Disable DHCP and set static IP address, subnet mask, gateway, DNS.

3. Door Station Settings

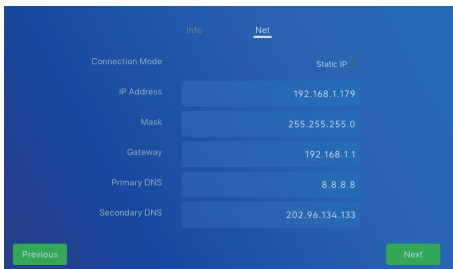
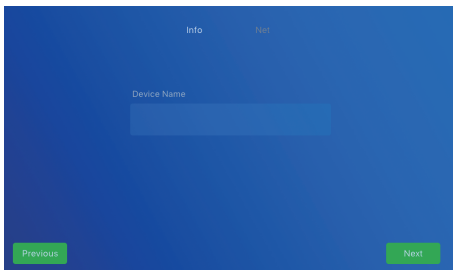
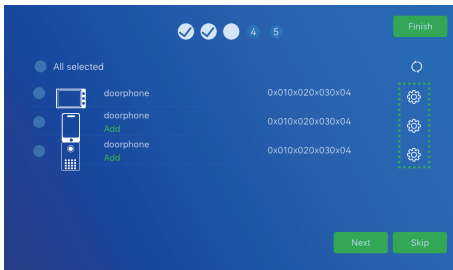

Scan Discovery Device, Select door station from the list, You can reset the device name and network information for each device.

Note: The door phone and indoor station devices need to be on the Same network segment.

4. Download the app



Scan the QR code to download the Fanvil Link app, or search for Fanvil Link in the App Store, Download on ios and google store or Fanvil website.

5. Register the app

App Registration Process:

5.1 Install the downloaded app.

5.2 After installation, open the app on your phone.

5.3 Click on the "Scan" button on the login screen.

5.4 Scan the QR code on the indoor unit to enter the registration page.

1) Choose to register with your phone number or email (default is email registration).

2) Enter your phone number or email, then click "Get Verification Code". The code will be sent to the specified phone number or email.

3) Enter the verification code.

4) Click "Submit" to complete registration successfully.

5.5 Set your login password.

5.6 Once completed, you will enter the app's main page.

6. Indoor Station Settings

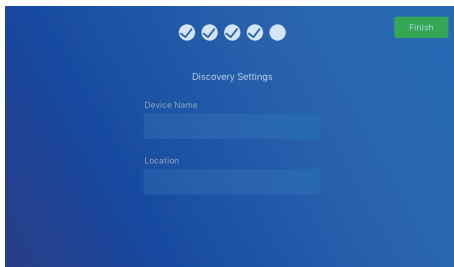

Set the indoor station name and location. After registering with the app, this step can be skipped.

Federal Communication Commission (FCC) — USA This device complies with Part 15 of FCC Rules. Operation is subject to the following two conditions: (1) this device may not cause harmful interference, and (2) this device must accept any interference received; including interference that may cause undesired operation. This equipment has been tested and found to comply with the limits for a Class B digital device, pursuant to Part 15 of the FCC Rules. These limits are designed to provide reasonable protection against harmful interference in residential installation. This equipment generates, uses, and can radiate radio frequency energy, and if it is not installed and used in accordance with the instruction manual, it may cause harmful interference to radio communications. However, there is no guarantee that interference will not occur in a particular installation. If this equipment does cause harmful interference to radio or television reception, which can be determined by turning the equipment off and on, the user is encouraged to try to correct the interference by one or more of the following measures:

- Reorient or relocate the receiving antenna.
- Increase the separation between the equipment and receiver.
- Connect the equipment into an outlet on a circuit different from that to which the receiver is connected.
- Consult the dealer or an experienced radio/TV technician for help.

Warning: Any changes or modifications to this unit not expressly approved by the party responsible for compliance could void the user's authority to operate the equipment.

FCC Radiation Exposure Statement: The equipment complies with FCC Radiation exposure limits set forth for uncontrolled environment. This equipment should be installed and operated with minimum distance 20cm between the radiator and your body.