

CS20

Portable Speakerphone



USER MANUAL

Directory	2
1. Introduction	3
2. In the box	3
3. Instructions	4
4. How to use	5
4.1. Power ON/OFF	5
4.2. Bluetooth pairing	5
4.3. USB Dongle set up	5
4.4. Call Control	6
4.5. Volume Up/Down	6
4.6. Mute	6
4.7. LED Indicator	6
5. How to Charge	7
5.1. Charge	7
5.2. Charge LED Indicator	7
6. Document Center	8
7. Safe Usage Guidelines	8

1. Introduction

CS20 is a portable speakerphone designed for personal desks or small meeting/huddle rooms.

Crystal communication

Flexible connectivity

Mainstream UC/Video conferencing services compatible

Ease-of-carry

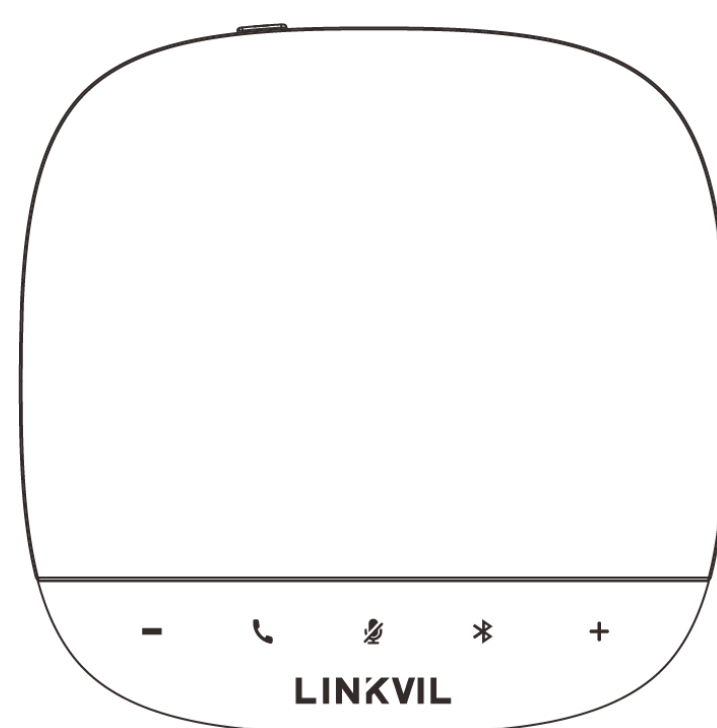

Features

- 3W speaker for small meeting/huddle rooms or personal
- 1.5m voice pickup range, ENC, ANS and AGC enabled
- Flexible connectivity with USB-A/C and Bluetooth
- Compatible with mainstream UC/Video conferencing services
- Modern ID with fabric speaker cover and ease-of-carry dimension

2. In the box

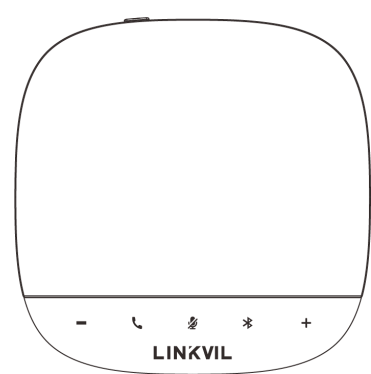

Speakerphone
CS20



Carry Bag

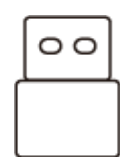

USB Dongle

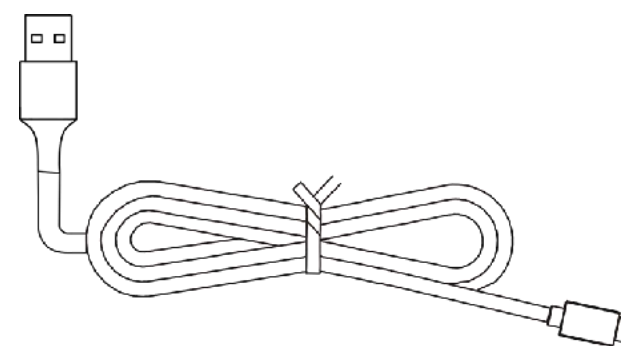

USB Cable

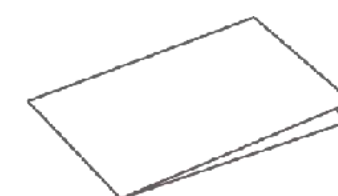

Quick Start Guide

3. Instructions

3.1. CS20 Portable speakerphone

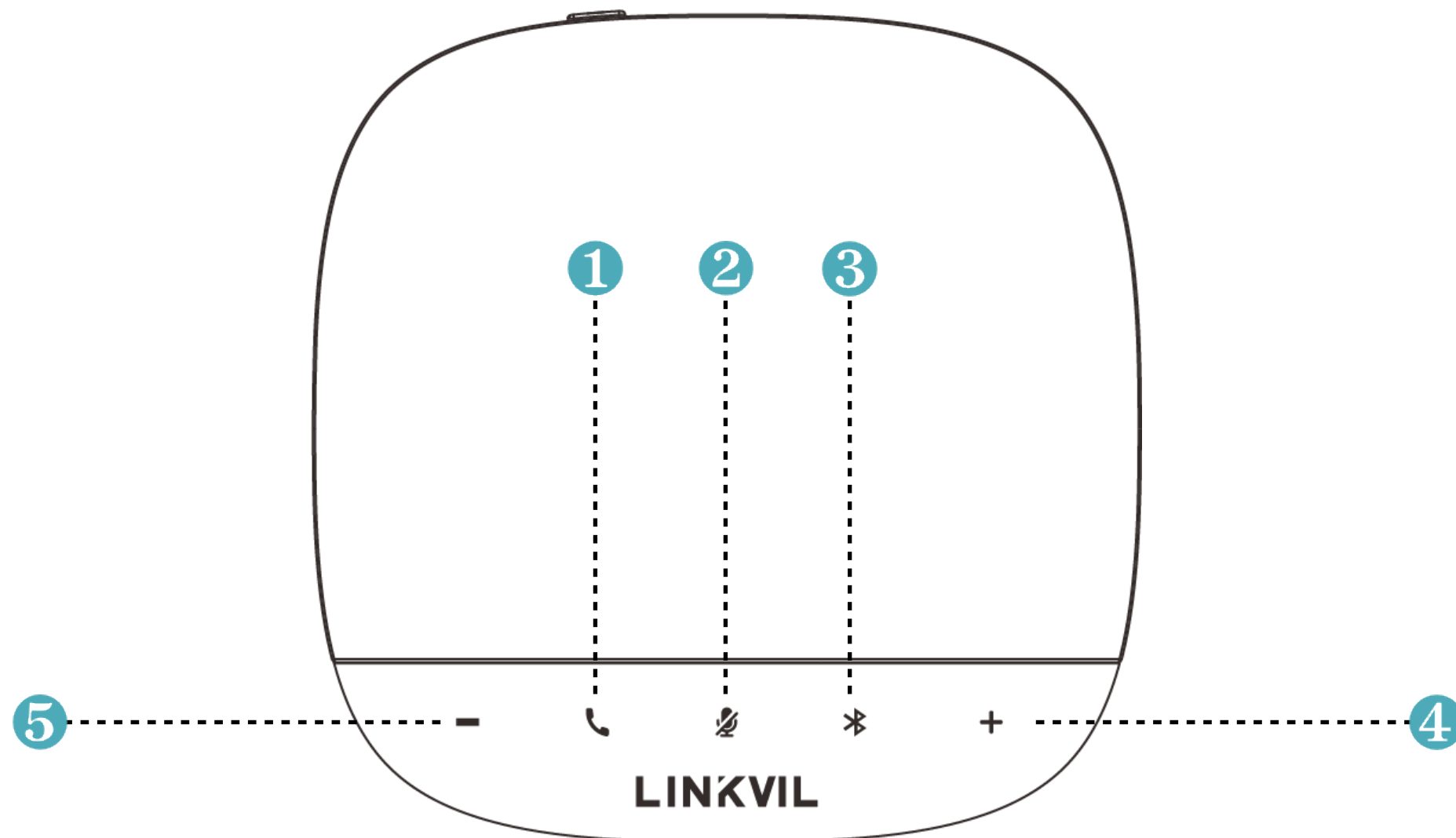

- | | | |
|--------------------|----------------|---------------|
| ① Call button | ④ Volume up | ⑦ Power LED |
| ② Mute button | ⑤ Volume down | ⑧ Type C Port |
| ③ Bluetooth button | ⑥ Power button | ⑨ USB Dongle |

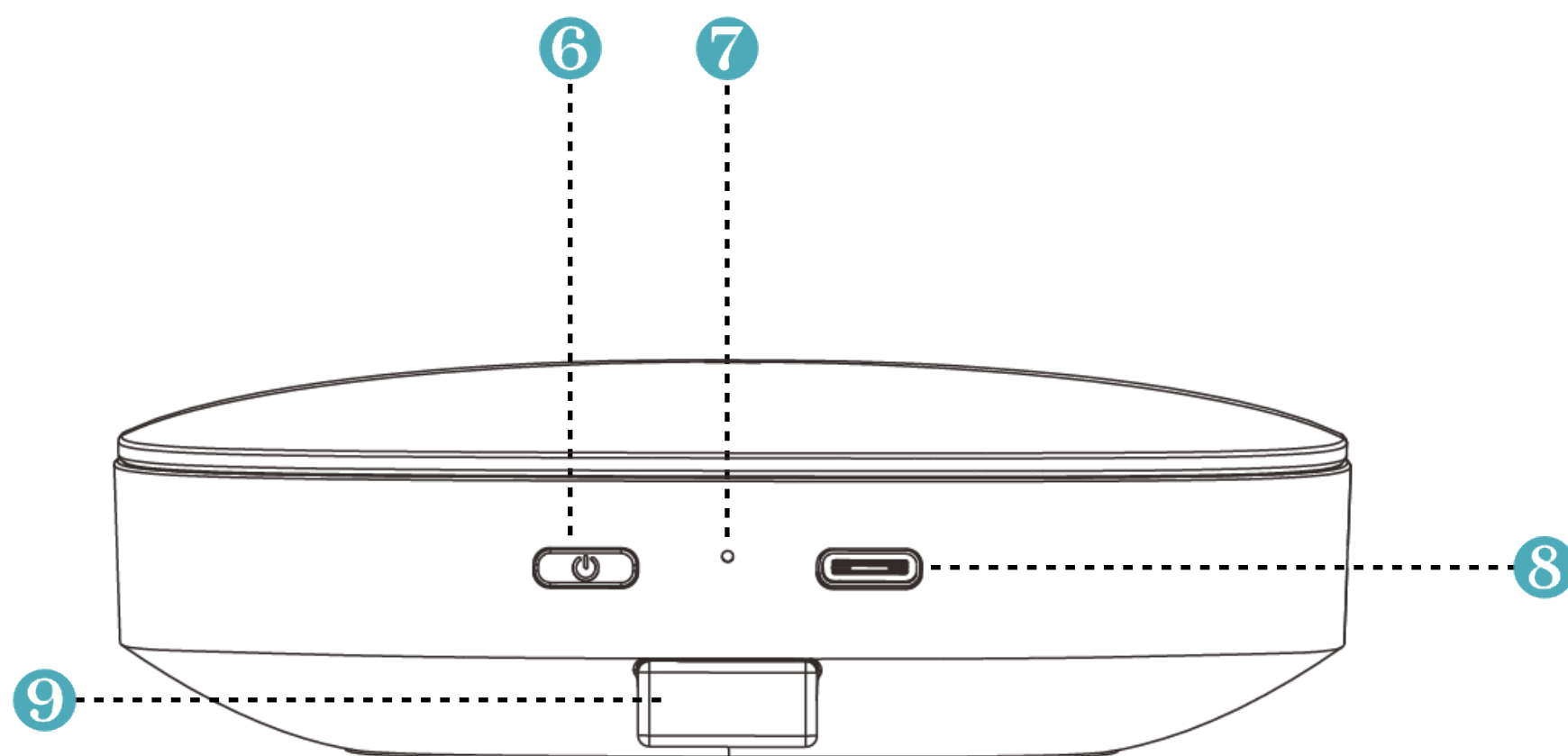

4. How to Use

4.1. Power ON/OFF

Hold power button 2s to power ON/OFF, the power LED can be light up when ON.

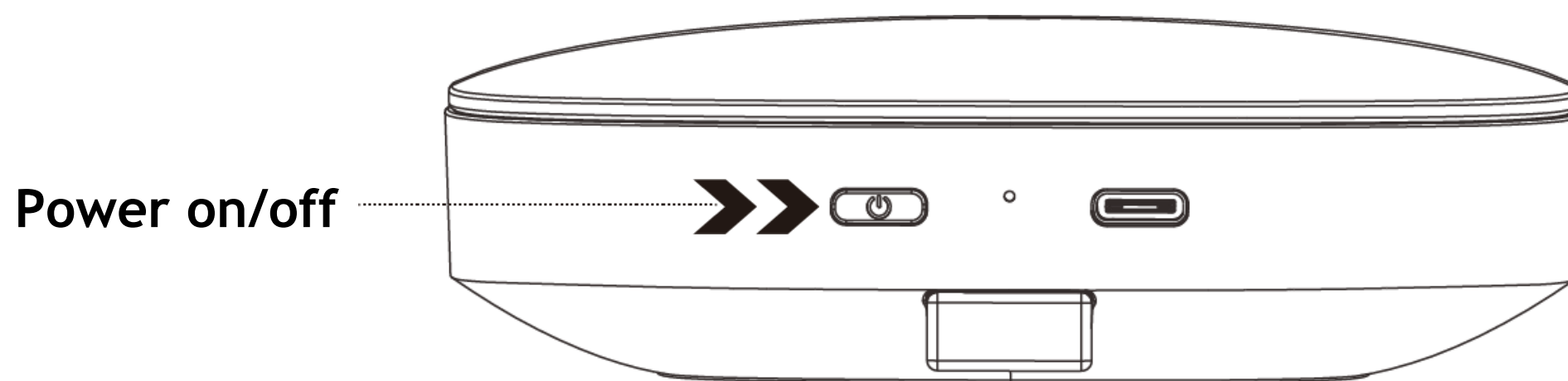

Tips

If there is no pairing or button operation within 20 minutes, the CS20 will automatically power OFF.

4.2. Bluetooth pairing

Press and hold Bluetooth button for 1s to enter pairing mode. From the list of Bluetooth devices, select “CS20” to pair it.

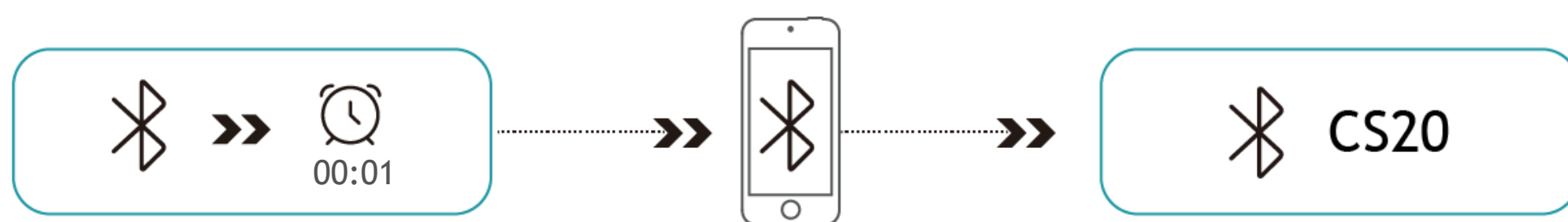

Tap the Bluetooth button in pairing mode, the pairing will be cancelled.

4.3. USB Dongle set up

Your Bluetooth USB adapter is already pre-paired with your speakerphone.

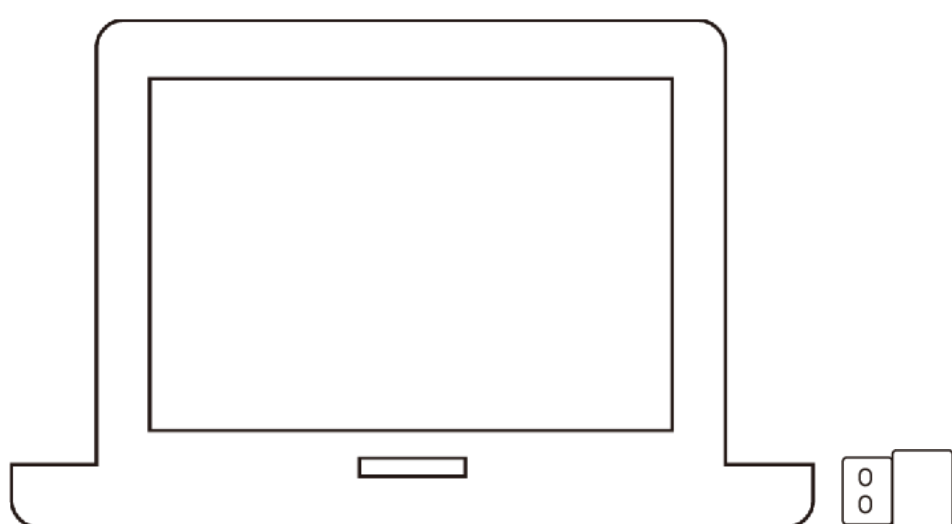

Inset USB Dongle to your computer, and keep speakerphone power on, select “BTCS20”.

4.4. Call button

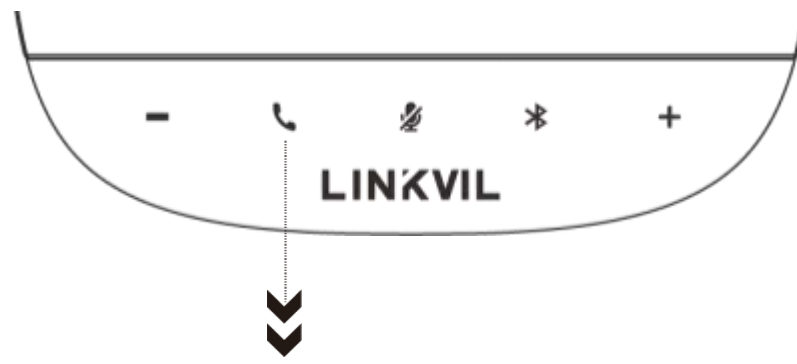

Play / Pause music	Answer / Hang up call	Reject call	Redial
Tap the call button	Tap the call button	Double click the call button	Double click the call button when idle

4.5. Volume Up/Down

To adjust the volume of the media audio or during a call, tap the volume up or down button.

4.6. Mute



4.7. LED Indicator

Event	LED Status					
	Call button		Bluetooth button		Mute button	
Power ON	Solid Green 3s		Solid Blue 3s		Solid Red 3s	
Incoming call	Flashing Green		/	/	/	/
In call	Solid Green		/	/	/	/
Mute	/	/	/	/	Solid Red	
Pairing	/	/	Flashing Blue		/	/
Connected	/	/	Solid Blue		/	/
Pairing failed	/	/	Flashing Blue 3s		/	/

5. How to Charge

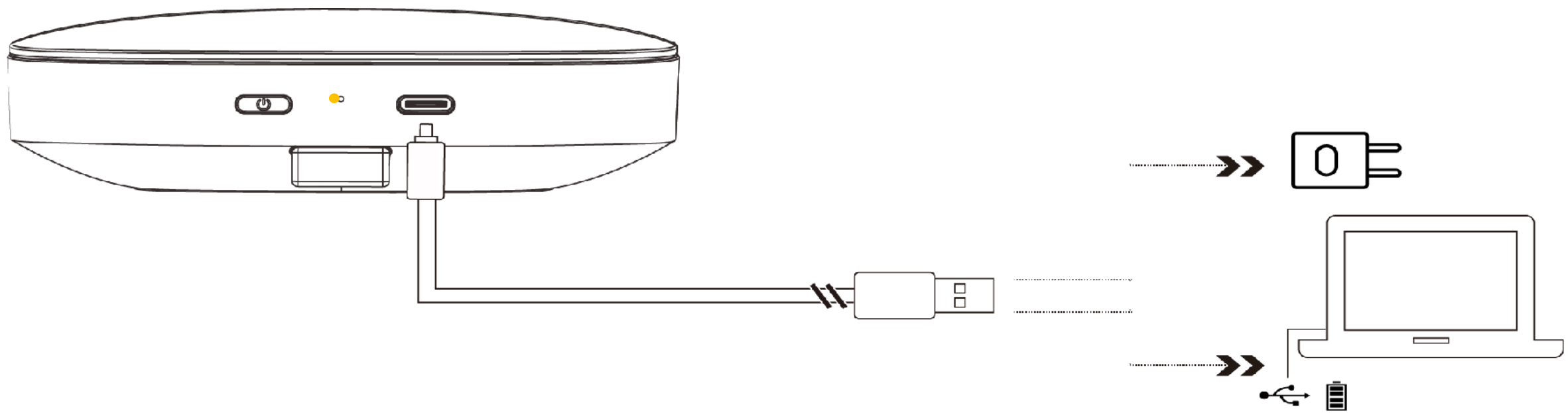

5.1. Charge

Connect the USB cable to power adapter* or computer, the LED bars will light up automatically and power ON.



 * Excessive voltage may cause damage to the product. Using a power supply that exceeds the specified voltage can damage the device or pose other potential risks. To ensure the safety and proper operation of the device, be sure to use the power specifications provided in the packaging or an equivalent power supply.

5.2. Charge LED Indicator

Event	LED Status	
Full of battery	Solid Green	
Charging	Solid Orange	

 When the power of CS20 drops below 10%, the Power LED will flash red. Please charge CS20 as soon as possible.

6. Document Center



Following documents can be downloaded from our document center:
Datasheet, Quick Start Guide, User manual, FAQ



<https://fanvil.com/service/doc/file/linkvils/linkvil/cs20/index.html>

7. Safe Usage Guidelines

- Do not open modify the product except for internal parts removal and replacement.
- Do not disassemble or attempt to service the product.
- This Product is safe under normal and reasonably foreseeable misuse operating conditions.
- If product is operating improperly, contact the authorized reseller.
- Product must be returned to the authorized reseller for any service or repair.
- This is not a Children's Product and is not intended for use by children under 14 years old.

About FANVIL

FANVIL Technology Co., Ltd. (FANVIL) is a leading global provider of A&V-IoT (Audio& Video- IoT) devices with three R&D centers in Beijing, Shenzhen, and Suzhou, China, and three factories in Huizhou and Shangrao, China, and Vietnam. FANVIL has focused on Unified Communication technology innovation for more than 20 years and provides SIP phones and SIP security industrial products in the global market. As the pioneer in applying standardized network communication technology and Audio & Video technologies to build A&V IoT, we are boosting the digital transformation for multiple industries.

About LINKVIL

As the sub-brand of FANVIL, LINKVIL will focus on the research and development of A&V-IoT wireless communication products. Based on Audio & Video -IoT, LINKVIL helps to achieve the full connection of wireless communication systems. LINKVIL builds a wireless communication Eco-system for multi-scenarios to help accelerate digital transformation.

Copyright

Copyright © 2024 FANVIL Technology Co., Ltd.

All rights reserved. No parts of this publication may be reproduced or transmitted in any form or by any means, electronic or mechanical, photocopying, recording, or otherwise, for any purpose, without the express written permission of FANVIL Technology Co., Ltd.

More Information

The above specifications may be updated in the future without prior notice. All hardware/software/physical features should be based on the final shipped products. For more information, please visit: www.fanvil.com

Compliance



FANVIL | LINKVIL

FANVIL Technology Co., Ltd.

Web: www.fanvil.com

Add: 10/F Block A, Dualshine Global Science Innovation Center, Honglang North 2nd Road, Bao'an District, Shenzhen, China

Copyright © 2024 Fanvil Technology Co., Ltd.