



PoLRE[®] Switch Hardware Installation Guide

Release 1.5



Proprietary Notice

Copyright © 2023 NVT Phybridge Inc. All rights reserved.

All information contained in this document is confidential and proprietary to NVT Phybridge Inc. Any disclosure, duplication, reproduction or transmission of this document or the information it contains is prohibited without the prior written authorization of NVT Phybridge Inc.

NVT Phybridge believes that at the time of publication, this document accurately reflects PoLRE switch and Phylink adapter features, requirements, and specifications. However, this document may contain errors or omissions, and NVT Phybridge makes no warranties regarding the content of this document.

NVT Phybridge is not responsible for any loss or damages arising from the use or misuse of this document.

The information contained in this document as well as all product specifications are subject to change without notice.

Trademarks

NVT Phybridge, PoLRE, and Phylink are trademarks of NVT Phybridge Inc.

All other trademarks, registered trademarks and service marks are the property of their respective owners.

NVT Phybridge Inc. Corporate Headquarters

3457 Superior Court

Unit 3

Oakville, ON

L6L 0C4, Canada

www.nvtphybridge.com

NVT Phybridge PoLRE Switch Hardware Installation Guide

Release 1.5 – 2023

®, ™ Trademark of NVT Phybridge Inc.

© Copyright 2023, NVT Phybridge Inc.

All rights reserved

Warranty Information

All statements in this document concerning the NVT Phybridge PoLRE switch are for informational purposes only. No part of this document constitutes a warranty, either express or implied, regarding the PoLRE switch. Our standard limited warranty is provided with the sales contract and/or product package.

Service and Support

NVT Phybridge is dedicated to customer satisfaction and the high quality of its products. Our technical support team is prepared to assist you in maximizing the efficiency and dependability of your PoLRE switch environment and will provide you with an immediate solution should a problem with your product arise. Contact us to discuss a plan of action and be prepared to provide us with:

Returning a PoLRE Switch

If you must return a PoLRE switch, Phylink adapter or accessory component to NVT Phybridge Inc., ensure that all items are adequately protected with insulating material and packaged in the original carton before shipping. Failure to do so may void the equipment warranty. Consult the warranty statements included with the sales contract and/or product package. Contact us for specific RMA requirements before you ship.

Audience

This document is intended for the use of service technicians, system administrators, information technology experts and other personnel who are qualified to install, configure, and maintain the PoLRE switch in the IP network environment. The tasks and procedures described in this guide require a basic understanding of IP communications, Ethernet LAN networks and the strategies and solutions currently practiced in your network environment. This document assumes that you are familiar with the architecture, specifications, and functionality of your network. You can sign up for Online technical training on the website.

Document Conventions

In this document, some instructions are given particular emphasis to denote cautions, warnings, and notes.

Cautions

A caution contains an instruction that the reader *must* follow in order to **prevent damage to equipment, network failure or loss of data**.

Example:



CAUTION: Do not expose the PoLRE switch or any of its components to a magnetic field or electrostatic charge. Damage to system components could result.

Warnings

A warning contains an instruction that the reader *must* follow in order to **prevent electrical shock, death or serious injury to personnel**.

Example:



WARNING: Ensure that the PoLRE switch is independently grounded with a wire securely attached to the ground lug at the rear of the switch.

Notes or Tips

A note or tip provides helpful information related to the topic of discussion.

Examples:



Note: The power supply unit is a field-replaceable part.



Tip: Use the handle on the right side to pull the power supply unit out.

Contents

Quick Links	1
Introduction	2
PoLRE Switch Hardware Description	3
Phylink Adapter Hardware Description	11
Phylink Dimensions	11
Network Infrastructure Connector	11
Ethernet Connector	12
PoLRE Switch Product Package	13
Before You Install	14
Power	14
Ventilation	14
Downlink	14
What You Will Need	15
Installation Quick Links	16
Requirements	17
Safety Precautions	18
ESD Procedure	18
Safety Warnings and Precautions	19
Care of the PoLRE Switch	19
Care of Replaceable Components	20
Overview of Installation	21
Installing the Switch in a Rack	22
Rackmount Safety Instructions	23
Replacing Legacy Devices with IP Endpoint Devices	24
Connecting a PC Behind an IP Phone	25
Connecting to the 2-wire Network Infrastructure	26
Connecting to the Console	27
Connecting to the IP PBX	28
GbE Port Connection	28
Gbic Port Connection	29
Installing the SFP Transceiver Modules	29
Installing the Fiber Optic Cable	31
Connecting to Power	33
AC Connection	33
Multiple Switch Configurations	34
Daisy-chaining PoLRE Switches for Powershare	34
Replacing the Power Supply Unit	36
INDEX	41

1. Product Description

Quick Links

- [PoLRE Switch Front View \(Models 24-Port and 48-Port\), page 3](#)
- [PoLRE Switch Rear View \(Models 24-Port and 48-Port\), page 4](#)
- [Power Supply Unit, page 5](#)
- [Uplink Ports, page 6](#)
- [Downlink Ports, page 7](#)
- [Out-of-band Management Port, page 8](#)
- [Console Port, page 9](#)
- [Reset Button, page 10](#)
- [Status Indicators, page 10](#)
- [Phylink Adapter Hardware Description, page 11](#)

Introduction

The PoLRE switch is a Power over Long Reach Ethernet switch. Unlike traditional Ethernet switches, the PoLRE switch has a reach of up to 1200 feet (365 meters) and is capable of delivering power and signaling over a single pair CAT3 cable. A Phylink adapter is installed at each IP endpoint, carrying the power, and signaling to the connected IEEE 802.3af compliant end devices.

The default PoLRE configuration supports IP devices and provides a plug and play solution for replacing a legacy analog network using the existing network cabling plan. Up to 48 IP devices can be powered from a single PoLRE switch.

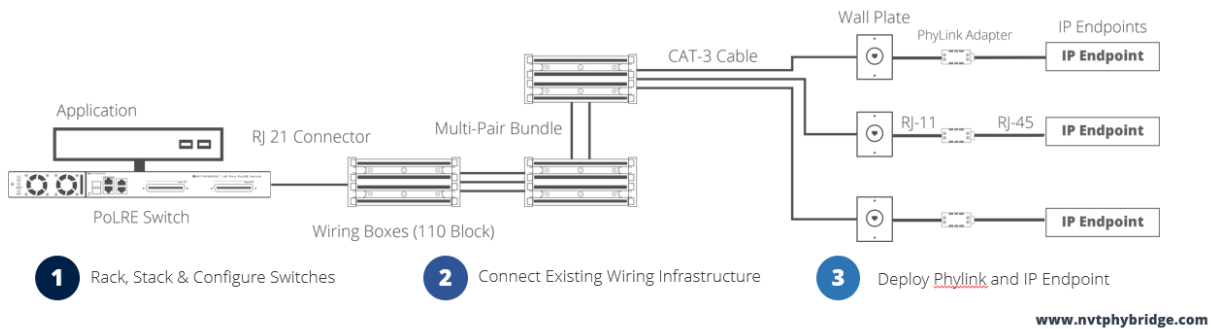

The PoLRE switch is a 1U, 19", rackmount 24/48-port Power over Ethernet (PoE) switch. Its upstream ports connect to the IP PBX, router, or data switch over a GbE copper connection. Unlike the typical PoE switch, however, its downstream ports connect to either one or two 25-pair RJ21 connectors and run over voice-grade CAT3 cable extending up to 1200 feet (365 meters).

This permits the use of a legacy 2-wire telephony infrastructure to carry voice, data and signals between the upstream switch or IP PBX to all IP endpoints in the network. Phylink adapters at the IP endpoints are like media converters that switch from the single CAT3 pair to a standard RJ45 Ethernet PoE connection for connectivity and power to the attached IP device.

Important: Devices attached at the IP endpoints must be IEEE 802.3af compliant.

Multiple PoLRE switches can also be daisy-chained together to operate in Powershare mode if one switch's power supply should fail.

PoLRE Switch Hardware Description

PoLRE Switch Front View (24- and 48-Port Models)

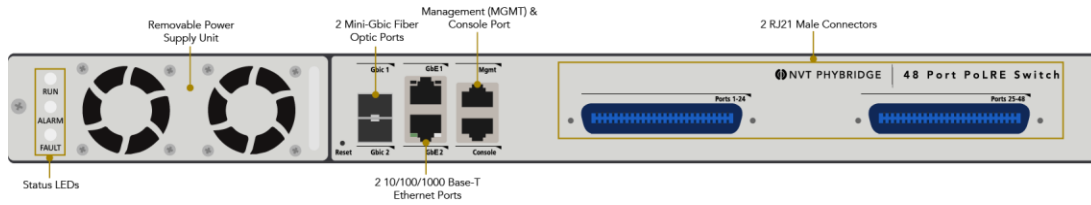

PoLRE 48-Port Managed Switch (Model NV-PL-048)

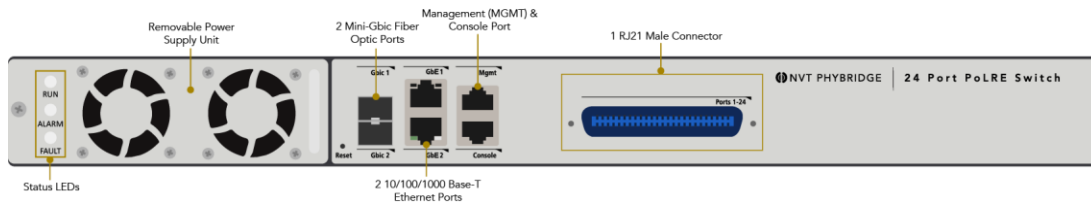

PoLRE 24-Port Managed Switch (Model NV-PL-024)

PoLRE Switch Rear View (24- and 48-Port Models)

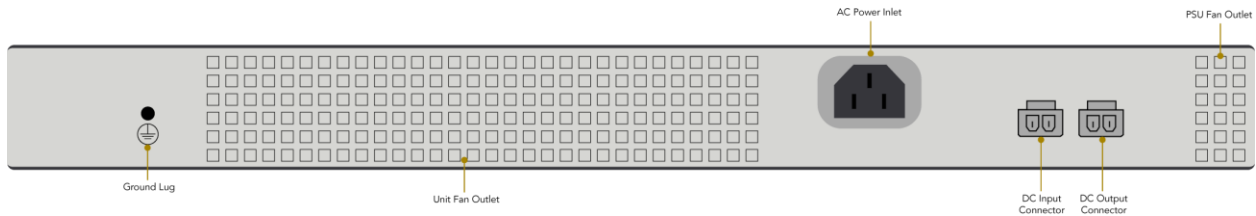

PoLRE Switch Product Numbers

The nameplate affixed to the bottom of the PoLRE switch indicates the generic model number (24-Ports or 48-Ports). The product serial number as well as the switch-specific model number are on a label affixed to the left side of the rear panel. You may be asked to provide these numbers if you contact NVT Phybridge Technical Support for assistance.

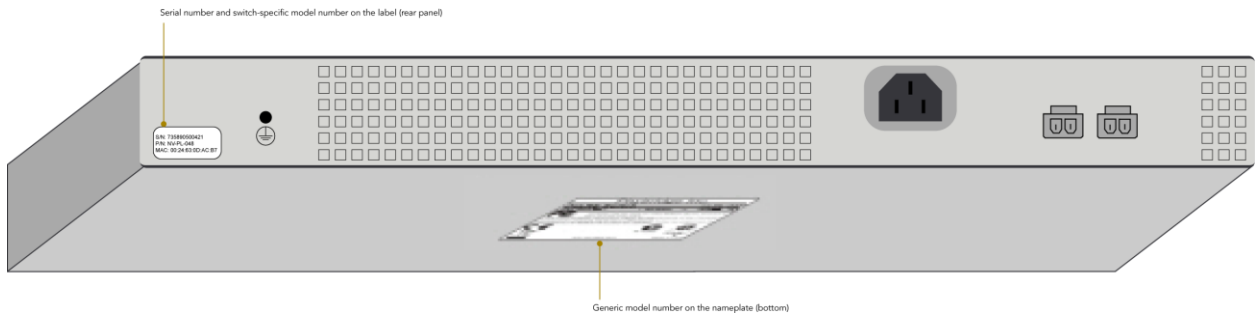

PoLRE Switch Dimensions

- 19", 1U
- Height: 4.45cm (1.75")
- Width: 43.5cm (17.13")
- Depth: 25.2 cm (9.92")
- Weight: 3.61 kg (7.96 lb.)

Operating/Storage Environment

- Operating temperature: -10°C to 50°C (14°F to 122°F)
- Storage temperature: -25°C to 70°C (-4°F to 158°F)
- Relative humidity: 10% to 95% (non-condensing) at 35°C (95°F)

Internal Components

- Processor: Broadcom BCM56018 switch processor, 266 MHz
- Memory: 32MB FLASH, 64MB DDR SDRAM

Power Supply Unit

- Field-replaceable AC power supply unit (PSU)
- 1 male AC connector at the rear: Autosensing 100-240VAC, 50/60 Hz
- 2 male DC connectors (In/Out) at the rear of the unit for Power share: -54VDC (nominal), -42VDC to -58VDC tolerance
- Power output: 500W max at 100VAC; 1000W max at 240VAC
- Power injection (PoE): 58VDC; endpoint devices must be compliant with IEEE 802.3af
- 2 fans for cooling, front to rear
- 3 LEDs at the front: RUN (green), ALARM (amber) and FAULT (red). Refer to page 10.

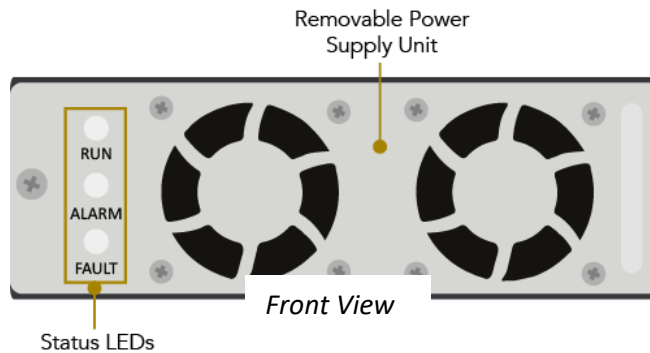

CAUTION: Do not lift the PoLRE switch using the handle at the front of the power supply unit. This handle is intended for removing and replacing the PSU only. Refer to Replacing the Power Supply Unit, page 36.



Uplink Ports

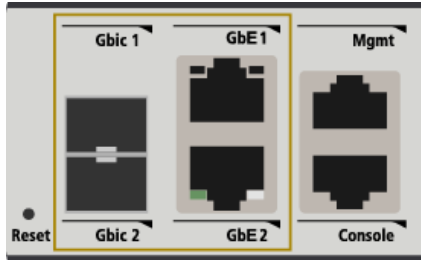

Pin	Function
1, 2	T/Rx+, T/Rx-
3, 6	T/Rx+, T/Rx-
4, 5	T/Rx+, T/Rx-
7, 8	T/Rx+, T/Rx-

- Provide Ethernet uplink connections (trunk) to the IP PBX, router, or data switch
- Permit in-band management from a computer connected to the LAN, including all system OAM&P functions: software updates, configuration upload/download, status monitoring and management system interactions
- Speed: 1 GbE, full duplex
- Number of ports: Total of 2
- Cable required: copper, CAT-5e or better



CAUTION: Do not connect both ports to the network unless STP/RSTP is enabled. For more information, see the PoLRE Switch User Guide as well as the 3300/MCD Resiliency Guidelines.

Port Label	Port Type	Cable Required
GbE 1, GbE 2	RJ45, Ethernet IEEE 802.3 10/100/1000 Base-T autosensing, independent speed selection Auto-MDIX	CAT-5e copper cable

GbE Port Pinout

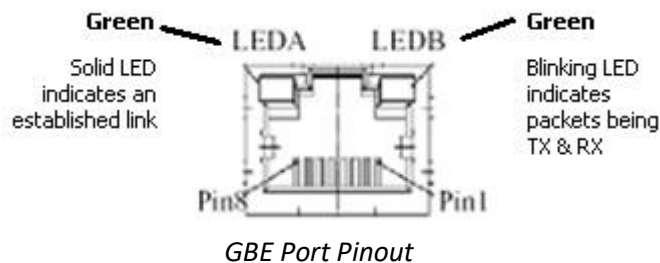

Downlink Ports

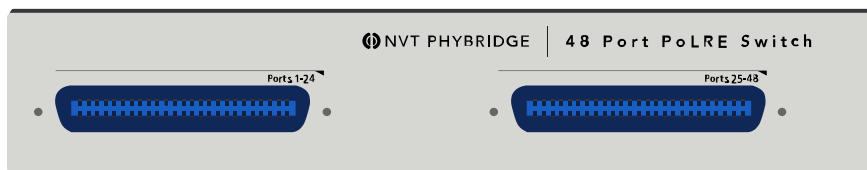

- Provide downlink connections (Ethernet with PoE)
- Speed: 10 Mb/s, full duplex
- Number of ports:
 - Model 24-Port: 1 RJ21 male telco connector (standard), 24 pairs used
 - Model 48-Port: 2 RJ21 male telco connectors (standard), 48 pairs used
- Cable required: CAT3 UTP, 24 AWG
- Maximum cable length: 1200' (365 m)
- PoE power: 15 Watts

Downlink Port Pinout

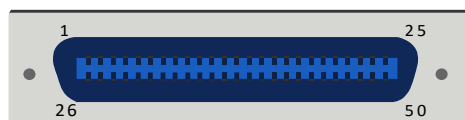

Ports 1 to 24:

PIN Number	1	2	3	4	5	6	7	8		18	19	20	21	22	23	24	25
Port Number	TR +- 1	TR +- 2	TR +- 3	TR +- 4	TR +- 5	TR +- 6	TR +- 7	TR +- 8		TR +- 18	TR +- 19	TR +- 20	TR +- 21	TR +- 22	TR +- 23	TR +- 24	X
PIN Number	26	27	28	29	30	31	32	33		43	44	45	46	47	48	49	50
Port Number	TR +- 1	TR +- 2	TR +- 3	TR +- 4	TR +- 5	TR +- 6	TR +- 7	TR +- 8		TR +- 18	TR +- 19	TR +- 20	TR +- 21	TR +- 22	TR +- 23	TR +- 24	X

Ports 25 to 48:

PIN Number	1	2	3	4	5	6	7	8		18	19	20	21	22	23	24	25
Port Number	TR +- 25	TR +- 26	TR +- 27	TR +- 28	TR +- 29	TR +- 30	TR +- 31	TR +- 32		TR +- 42	TR +- 43	TR +- 44	TR +- 45	TR +- 46	TR +- 47	TR +- 48	X
PIN Number	26	27	28	29	30	31	32	33		43	44	45	46	47	48	49	50
Port Number	TR +- 25	TR +- 26	TR +- 27	TR +- 28	TR +- 29	TR +- 30	TR +- 31	TR +- 32		TR +- 42	TR +- 43	TR +- 44	TR +- 45	TR +- 46	TR +- 47	TR +- 48	X

Out-of-band Management Port

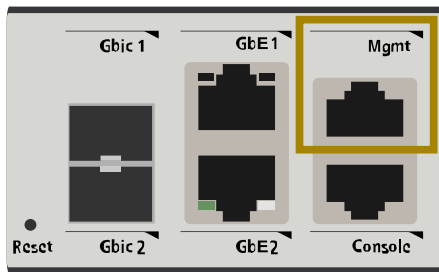

- 1 IEEE 802.3 Ethernet LAN port labeled **MGMT**
- Dedicated port for out-of-band management of the PoLRE switch, including all system OAM&P functions
- Speed: 10/100 Base-T autosensing Auto-MDIX
- Cable required: standard RJ45 LAN cable, CAT-5 or better

Out-of-band Management Port Pinout

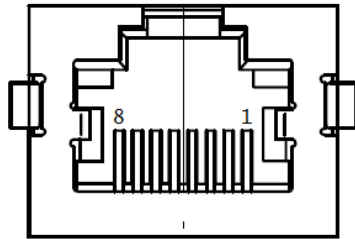

Pin	Function
1	TX +
2	TX -
3	RX +
4, 5	Bob Smith Termination
6	Rx -
7, 8	Bob Smith Termination

Console Port

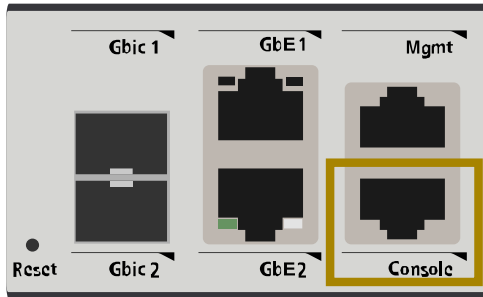

- 1 RJ45 UART port labeled **Console**
- Dedicated port for management of the PoLRE switch via a console terminal or PC
- Speed: 115200 Baud
- 8 data bits, no parity, 1 stop bit
- Cable required: RS232 RJ45 to DB9 connector

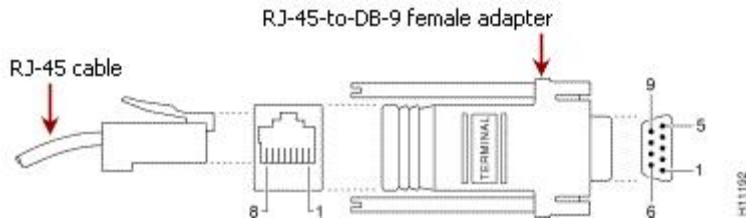

Console Port	RTS	DTR	TxD	GND	GND	RxD	DSR	CTS
RJ45 Pin	1	2	3	4	5	6	7	8
DB-9 Pin	8	6	2	5	5	3	4	7
Console Device	CTS	DSR	RxD	GND	GND	TxD	DTR	RTS

Reset Button

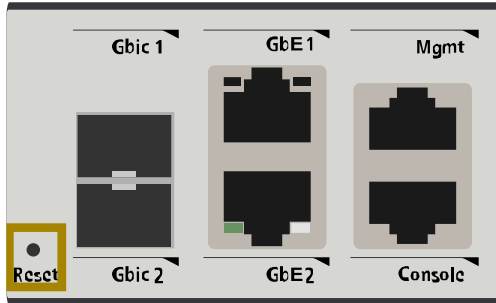

- Recessed button labeled **Reset**, for manually restarting the PoLRE switch
- Located on the front panel of the PoLRE switch immediately to the right of the power supply unit
- Use a paper clip or something similar to press the Reset button in



CAUTION: Do NOT use a pencil tip to press the Reset button.



Note: If you press and hold for 10 seconds, the PoLRE switch will revert to its factory configuration. If you press and hold for under 10 seconds, the PoLRE switch will reboot.

Status Indicators

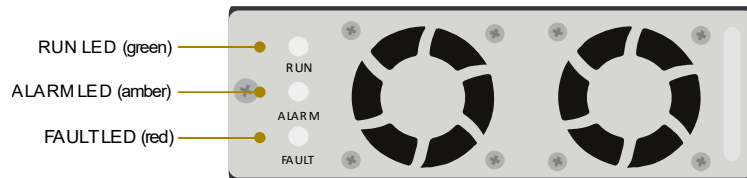

3 LEDs on the front panel of the power supply unit indicate the operating status of the PSU and the PoLRE switch:

- **RUN** (green): Flashes during startup. Lights solid when the PoLRE switch is up and running.
- **ALARM** (amber): Flashes once during startup, then turns off. Lights solid to indicate a problem with the PSU.
- **FAULT** (red): Flashes once during startup, then turns off. Lights solid to indicate a PoLRE switch software or hardware failure. Contact Phybridge Technical Support for assistance.

Phylink Adapter Hardware Description



Phylink Product Number

The nameplate affixed to the top of the Phylink adapter enclosure indicates the product model number. You may be asked to provide this number if you contact NVT Phybridge Technical Support for assistance.

Product Nameplate Location

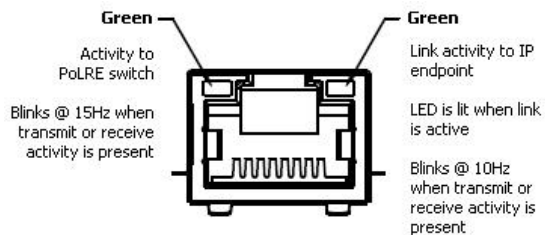

Phylink Dimensions

- Height: 1.8cm (0.71")
- Width: 2.8cm (1.1")
- Depth: 6.5cm (2.56")
- Weight: 22 g (0.78 oz.)

Network Infrastructure Connector

- RJ11 port
- Connects to the single CAT3 pair on the legacy infrastructure side

Ethernet Connector

- RJ45 port
- Provides connectivity and power to the IP end device.
- DC voltage -58V max; -37V when 365m (1200') away from the PoLRE switch
- Speed: Fixed 10 Mb/s Full Duplex Auto-MDIX
- Cable: CAT-5 or better

2. Unpacking

PoLRE Switch Product Package

When you first take the PoLRE switch out of its carton, lay out the switch and all of its accessories in your work area and verify that you have received all of the items you ordered. Each component is labeled with its part number. The basic PoLRE switch product package includes:

- 1 PoLRE switch, model 24-Port or model 48-Port
- 1 rackmount bracket kit
- 1 console cable
- 1 power cord
- Other PoLRE components are packaged separately for installation in the field. Verify that you have received all of the items you ordered.
- Phylink adapters. The number of adapters shipped is determined from your order.



- (Optional) Replacement power supply unit. Note that the PoLRE switch comes standard with a factory installed power supply unit.



Returning a PoLRE Switch

Contact NVT Phybridge immediately if any parts are missing or have been damaged during shipment. Retain the shipping order and invoice for confirmation.

Before You Install



WARNING: The PoLRE switch can be installed in any indoor location in all countries except in Finland, Norway and Sweden, where, **in these three Nordic countries, it must be installed in a restricted access location.**

The location must meet the following size, distance, and environmental criteria.

Size Requirements

Select a standard 19" equipment rack or, for a standalone PoLRE switch, a flat, stable surface capable of supporting the size and weight of the PoLRE switch, its installable components and cabling. Refer to **Error! Reference source not found.** PoLRE Switch Dimensions, page 4.

Ensure that you have enough rack space for all equipment. Shelves and rear supporting brackets are not mandatory. See Installing the Switch in a Rack, page 22.

Physical Location Requirements

Power

The PoLRE switch must be placed within 6 feet of an available AC power source. Do not use an extension cord to connect the equipment to a power outlet.

Ventilation

To ensure proper ventilation of the PoLRE switch, leave at least 2 inches of unobstructed space on all sides of the switch. If the fans are blocked, the unit could overheat. Refer also to Operating/Storage Environment, page 4.

Downlink

The Phylink adapters can be installed up to 1200' (365m) away from the PoLRE switch.

What You Will Need

Installation procedures will be trouble-free if you ensure that the following items are available before you begin:

- The PoLRE switch and all cables and accessories you received
- All Phylink adapters required for connecting the IP endpoint devices, provided with the product package according to the quantity ordered
- Standard CAT5e copper LAN cables for the **GbE** uplink trunks (user-supplied)
- Standard CAT3 unshielded single twisted pair cables, 24 AWG, for the downlink ports (user-supplied)
- Serial console cable for the **CONSOLE** port, provided with the product package
- Standard CAT-5 or CAT-6 Ethernet LAN cable for the **MGMT** port (user-supplied)
- DC cables for multiple switch configuration in PowerShare mode (optional)
- Screws and screwdriver for securing the PoLRE switch to the standard 19" equipment rack
- A PC with a COM port for configuration and management of the PoLRE switch
- If the PC connection is via a USB port, a USB cable will be required
- If the out-of-band management port will be used, a standard RJ45 LAN cable will be required



Note: In-band management is also available through any of the Gigabit Ethernet (uplink) ports on the PoLRE switch, permitting remote access via a LAN connection.

Details on product configuration and management are provided in the PoLRE Switch User Guide.

3. Installation

Quick Links

- [Overview of Installation, page 21](#)
- [Installing the Switch in a Rack, page 22](#)
- [Replacing Legacy Devices with IP Endpoint Devices, page 24](#)
- [Connecting a PC Behind an IP Phone, page 25](#)
- [Connecting to the 2-wire Network Infrastructure, page 26](#)
- [Connecting to the Console, page 27](#)
- [Connecting to the IP PBX, page 28](#)
- [Connecting to Power, page 33](#)
- [Daisy-chaining PoLRE Switches for Powershare, page 34](#)
- [Replacing the Power Supply Unit, page 36](#)

Requirements

Before you install the PoLRE switch, start it up or replace any components, review the suggestions in Before You Install page 14 concerning:

- Size Requirements **Error! Reference source not found.**, page 14
- Physical Location Requirements, page 14
- What You Will Need, page 15

Safety Precautions



WARNING: To prevent possible personal injury or equipment damage, do not apply power to the PoLRE switch system until all other installation steps have been properly completed.



WARNING: Ensure that the PoLRE switch is independently grounded with a wire securely attached to the ground lug at the rear of the switch chassis.



CAUTION: When upgrading a telephony environment, make sure you have removed all of the old analog/digital phones and fax machines before you apply power.



CAUTION: To ensure trouble-free synchronization with the PoLRE switch upon startup, all IP endpoint devices must be installed before you connect the PoLRE switch to a power source.

See also Rackmount Safety Instructions, page 23.

ESD Procedure

ESD procedure is required for the PoLRE switch and all product components.



CAUTION: Do not expose the PoLRE switch, its removable components or the Phylink adapter to a magnetic field or electrostatic charge. Damage to system components could result.

- Wear an ESD (Electrostatic Sensitive Devices) wrist strap.
- Attach the wrist strap cable to the ground lug at the rear of the PoLRE switch, identified with the Gnd symbol  as shown below:

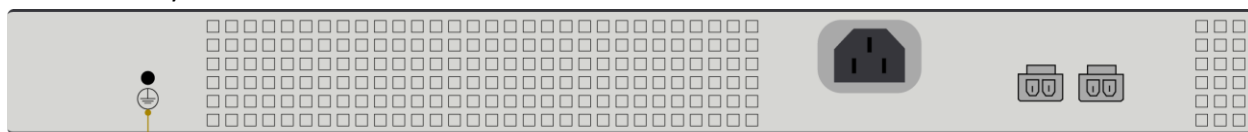

Ground lug location at the rear of the PoLRE switch chassis



CAUTION: The ground lug is a main earth terminal that must be permanently connected to earth.

Safety Warnings and Precautions



<p>Access to the interior of this unit shall be made only by a qualified technician.</p> <p>This unit may have more than one power input. To reduce the risk of energy or shock hazard, disconnect all power inputs before servicing the unit.</p> <p>To ensure adequate cooling of the equipment, a 2-inch unobstructed space must be provided around all sides of the unit.</p> <p>The Power Socket shall be installed near the equipment and shall be easily accessible.</p> <p>To prevent the risk of shock or fire hazard, replace fuse with same type and rating.</p> <p>CAUTION: The ground lug is a main earth terminal that must be permanently connected to earth.</p>	<p>Der Zugang ins Innere des Gerätes ist nur einem fachlich qualifizierten Techniker gestattet.</p> <p>Dieses Gerät kann mehr als eine Leistungsaufnahme. Um das Risiko von Energie oder Gefahr eines elektrischen Schlags zu reduzieren, trennen Sie alle Macht Eingaben, bevor Wartungsarbeiten an der Einheit.</p> <p>Um die Kühlung des Gerätes nicht zu beeinträchtigen, ist es notwendig, an allen Seiten des Gerätes ca 5 cm Raum zu lassen.</p> <p>Stellen Sie das Gerät in der Nähe eines geerdeten Schutzkontaktsteckers so auf, dass der Stecker leicht erreichbar und zugänglich ist.</p> <p>Zur Vermeidung der Stromschlag- und Feuergefahr beim Auswechseln Sicherungen des gleichen Typs und der gleichen Nennleistung einsetzen.</p> <p>VORSICHT: Die Erdungsöse ist einer der wichtigsten Erdungsklemme, die dauerhaft auf die Erde angeschlossen werden muss.</p>	<p>Seul un spécialiste doit avoir accès l'appareil.</p> <p>Cette unité peut avoir plus d'une entrée d'alimentation. Pour réduire le risque de danger de l'énergie ou de choc, débranchez toutes les entrées d'alimentation avant de réparer l'unité.</p> <p>Afin de ne pas nuire au processus de refroidissement, il est nécessaire de laisser un espace d'environ 5 cm de chaque côté de l'appareil.</p> <p>Placez l'appareil près d'une prise de courant facilement accessible.</p> <p>Afin d'éviter tout risque d'incendie ou d'électrocution, remplacez les fusibles par des fusibles de même type et de même ampérage.</p> <p>ATTENTION: La cosse de terre est une borne de terre principale qui doit être connectée en permanence à la terre.</p>	<p>El servicio de mantenimiento y reparación de esta unidad solo puede ser realizado por técnicos autorizados por el fabricante.</p> <p>Esta unidad puede tener más de una entrada de energía. Para reducir el riesgo de peligro de descargas eléctricas o descargas eléctricas, desconecte todas las entradas de alimentación antes de reparar la unidad.</p> <p>No bloquee las ranuras de ventilación del equipo, y aquellos componentes podrían sobrecalentarse y sufrir daños.</p> <p>Para evitar el riesgo de choque eléctrico o de incendio, reemplace el fusible como otro del mismo tipo y capacidad nominal</p> <p>Para su propia protección, cerciórese de que todas las conexiones eléctricas de los servicios públicos, incluyendo la puesta a tierra, las líneas telefónicas y el sistema de tuberías de agua metálicas internas, si las hubiera, estén conectadas entre sí.</p> <p>PRECAUCIÓN: El terminal de tierra es un terminal de tierra principal que debe estar permanentemente conectada a la tierra.</p>
---	--	--	--

Care of the PoLRE Switch



CAUTION: Power off the PoLRE switch before cleaning.

The PoLRE switch will not be damaged by the application of common household solvents, non-abrasive cleaners or waxes to any of its external surfaces. **However, these cleaning products must not be used on the components of the PoLRE switch or applied to the interior of the switch.**

Care of Replaceable Components



CAUTION: Handle replacement components with care.

- **Do not** drop them.
- **Do not** spill liquids on them.
- **Do not** subject them to a magnetic field or electrostatic charge.
- **Do not** keep them in a dusty area.
- **Do not** store them at extreme temperatures or in high humidity. See Operating/Storage Environment, page 4.



Note: To ensure trouble-free installation of components, keep them in their original packaging until they are installed.

Overview of Installation

For single-switch deployment in an IP environment:

1. Remove the PoLRE switch and all accompanying accessories from the packaging materials. See PoLRE Switch Product Package, page 13.
2. Install the rackmount brackets on the PoLRE switch and mount the switch in a standard 19" rack. See Installing the Switch in a Rack, page 22.
3. Remove all legacy analog/digital devices from the RJ11 wall jacks.



Note: It is extremely important that **no legacy devices be connected when you power on the PoLRE switch** (step 8).

4. Install a Phylink adapter on each IP device, and plug the other end of the Phylink adapter into the RJ11 wall jack. See Replacing Legacy Devices with IP Endpoint Devices, page 24.
5. Connect the telco cable. See Connecting to the 2-wire Network Infrastructure, page 26.
6. Connect the console cable. See Connecting to the Console, page 27.
7. Connect the uplink cable from a Gigabit port to the IP PBX or network switch. See Connecting to the IP PBX, page 28.
8. Connect the PoLRE switch to an AC-power source. See Connecting to power, page 7.

For multiple switch deployments, refer to **Daisy-chaining PoLRE Switches for Powershare, page 34.**



Note: This connection also permits in-band management over copper.



CAUTION: Do not connect both ports to the network unless STP/RSTP is enabled. For more information, see the PoLRE Switch User Guide as well as the 3300/MCD Resiliency Guidelines.

Installing the Switch in a Rack

The PoLRE switch product package includes 2 rackmount brackets that must be installed on the left and right sides of the switch using the 8 screws provided, for installation in a standard 19" rack.



Note: No screws are supplied for mounting the PoLRE switch in the rack. You need a minimum of 4 screws for each rack mounted switch. Select the proper screw type and size for your equipment rack. If the rack has square holes, you may need to insert clips first in order to secure the 10-32 screws.



The PoLRE Switches Installed in a Standard 19" Rack

To Install the Switch in a Rack:

1. Attach the left rackmount bracket to the left side of the PoLRE switch near the front, using 4 of the screws provided. The rack ear should be flush with the front panel of the PoLRE switch.

Install left
bracket with
screws provided



Installing the Switch in a Rack

1. Attach the right rackmount bracket to the right side of the PoLRE switch near the front, using the other 4 screws provided. The rack ear should be flush with the front panel of the PoLRE switch.



Install right
bracket with
screws provided

CONTINUED



CAUTION: Do not lift the PoLRE switch using the handle at the front of the power supply unit. This handle is intended for removing and replacing the PSU only.

2. Slide the PoLRE switch into the rack along its horizontal supports (or suspend the switch in place using another means of support) so that the rackmount brackets at the front of the switch are in line with the vertical supports at the front of the rack, and at least 2 of the 3 holes in each rackmount bracket are aligned with holes on the rack.
3. Install 2 mounting screws in the bottom holes of the rackmount brackets, and partially tighten them (finger tight). This will provide temporary support for the switch.
4. Install the other 2 mounting screws in the upper holes of the rackmount brackets, and partially tighten them.
5. Ensure that you have mounted the switch at the same height on both sides of the rack, then tighten all mounting screws securely.

Rackmount Safety Instructions

- **Elevated Operating Ambient:** If installed in a closed or multi-switch rack assembly, the operating ambient temperature of the rack environment may be greater than room ambient. Therefore, consideration should be given to installing the equipment in an environment compatible with the maximum ambient temperature, as specified in Operating/Storage Environment, page 4.
- **Reduced Air Flow:** Installation of the equipment in a rack should be such that the amount of air flow required for safe operation of the equipment is not compromised.
- **Mechanical Loading:** Mounting of the equipment in the rack should be such that a hazardous condition is not achieved due to uneven mechanical loading.
- **Circuit Overloading:** Consideration should be given to the connection of the equipment to the supply circuit and the effect that overloading of the circuits might have on overcurrent protection and supply wiring. Appropriate consideration of equipment nameplate ratings should be used when addressing this concern. For reliability reasons the PoLRE switch should be powered from a dedicated mains outlet.
- **Reliable Earthing:** Reliable earthing of rack-mounted equipment should be maintained. Particular attention should be given to supply connections other than direct connections to the branch circuit (e.g. use of power strips).

Replacing Legacy Devices with IP Endpoint Devices



CAUTION: To ensure trouble-free synchronization with the PoLRE switch upon startup, all IP endpoint devices must be installed before you connect the PoLRE switch to a power source.

To Replace the Legacy devices with IP endpoint devices:

1. **Important:** Remove all legacy analog/digital devices from their telco jacks (RJ11 wall plugs) before you carry out any further installation steps.
2. Connect the new IP devices to the Phylink adapters: Plug the IP devices to the RJ45 side of the Phylink adapter using a standard Ethernet cable.
3. Plug the other end of the Phylink adapter into the RJ11 wall plug using a standard CAT3 cable. From the RJ11 of the Phylink adapter to the wall jack, the existing silver satin can be used when doing a DNIC/POTS replacement. For BT-type wall plate connectors, use the optional BT Adapter Cable instead.

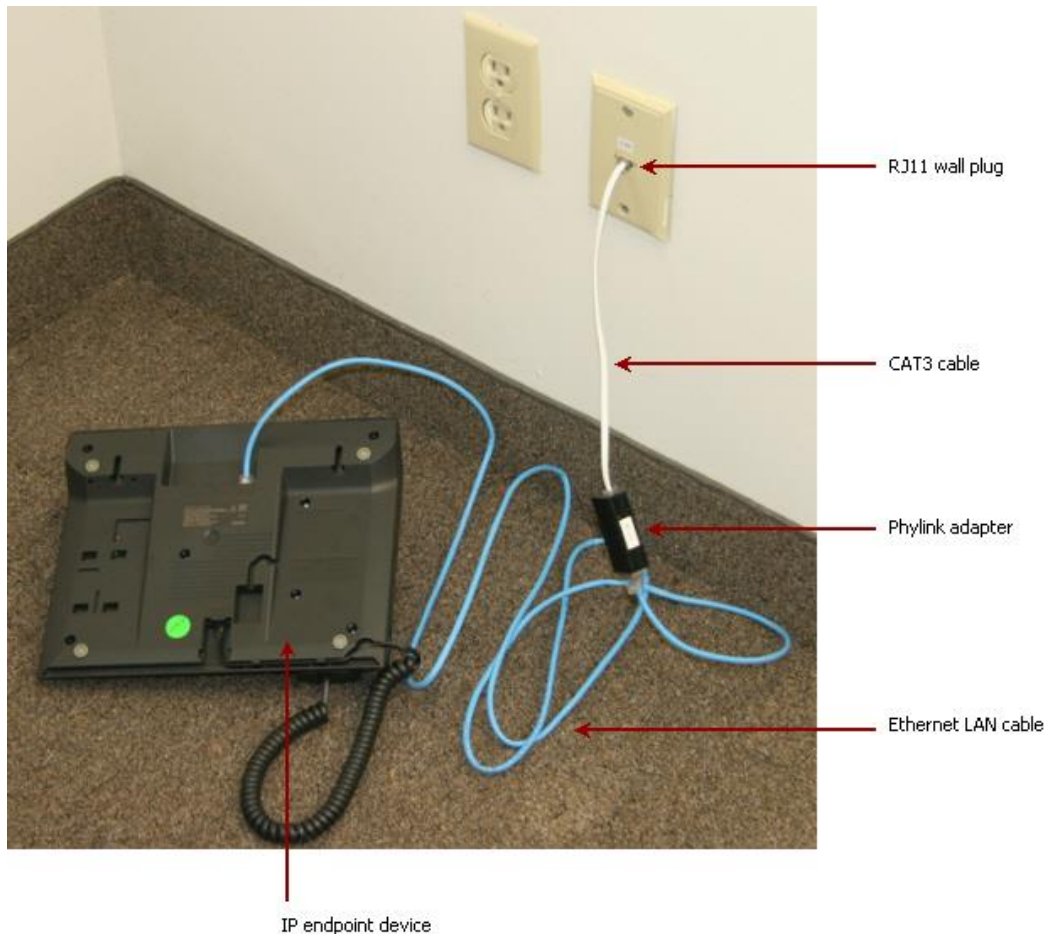

Connecting a PC Behind an IP Phone

- Plug one end of the CAT-5 or better cable to the Ethernet connector on the PC.
- Plug the other end of the same cable to the port marked LAN on the IP phone.
- It is recommended to establish VLANs to ensure Quality of Service. For more information on how to set up VLANs, see the PoLRE Switch User Guide.



Note: Data speeds are 10 Mb/s Full Duplex.

Connecting to the 2-wire Network Infrastructure



Note: Use a standard RJ21 telco cable to connect the 2-wire network infrastructure to one of the downlink ports on the front panel of the PoLRE switch. The total cable length of the network infrastructure (from PoLRE switch to Phylink adapter) can be up to 1200' (365m).

To Connect to the 2-wire Network Infrastructure:

1. Connect the female connector of the RJ21 telco cable to a downlink port.



Tip: If you are installing only one RJ21 telco cable on a model 48-Port, either downlink port can be used. However, for easier reference to port numbering, use the connector on the left, labeled **Ports 1 - 24**.



2. If you are installing a second RJ21 telco cable on a model 48-port, connect it to the port labeled **Ports 25 - 48**.
3. Screw the cable connectors securely into place.

Connecting to the Console

The PoLRE switch product package includes a standard RJ45 to DB9 female console cable for connection to a console terminal or a computer running a terminal emulation program. You will require a USB cable to connect to a USB port on a computer.



CAUTION: Do not connect the serial console cable to the management port labeled **MGMT**, which is for out-of-band management only.

To connect to the console:

1. Connect the RJ45 end of the supplied console cable to the port labeled **CONSOLE** on the front panel of the PoLRE switch.



2. Connect the DB9 end of the console cable to a COM port on your console terminal or computer.



Note: The terminal emulation program on your computer must be running at 115,200 baud with 8 data bits, no parity and 1 stop bit.

Connecting to the IP PBX

You can connect the PoLRE switch to the uplink network switch, IP PBX or router in two ways:

- GbE Port Connection (see next section) for copper LAN cable connection to either or both RJ45 ports labelled **GbE 1** and **GbE 2** on the front panel of the PoLRE switch.



Note: You need an Ethernet IEEE 802.3, CAT5e copper cable with RJ45 connectors for each **GbE** port connection.

- Gbic Port Connection, page 29, for fiber optic cable connection to either or both ports labelled **Gbic 1** and **Gbic 2** on the front panel of the PoLRE switch.



Note: The PoLRE switch supports multimode or single mode, depending on the requirements of the environment. For each **Gbic** port connection, you need a fiber optic cable that matches the Gbic specifications at the site. The **Gbic** ports require installing the SFP Transceiver Modules, page 29, before you connect the fiber optic cables.



CAUTION: The PoLRE switch supports a maximum of 2 uplink connections, either both GbE ports, both Gbic ports, or one of each. If you want to use one GbE port and one Gbic port, the port numbers must be different, for example GbE 1 and Gbic 2, or GbE 2 and Gbic 1. If you connect through same-numbered ports, for example GbE 1 and Gbic 1, only the fiber optic connection (Gbic) will work.

GbE Port Connection

To connect the PoLRE switch to the uplink network switch or IP PBX using a copper LAN cable:

- Connect your CAT5e copper LAN cable to port **GbE 1** or **GbE 2** on the front panel of the PoLRE switch.



CAUTION: Do not connect both ports to the network unless STP/RSTP is enabled. For more information, see the PoLRE Switch User Guide as well as the 3300/MCD Resiliency Guidelines.



Note: Both ports can be used. If only one connection will be installed, use the port labeled **GbE 1**.



Gbic Port Connection



CAUTION: Do not connect a fiber optic cable to a **Gbic** port on the PoLRE switch if a legacy analog or digital **device** is still connected at any endpoint in the system. The default configuration of the PoLRE switch provides power to all ports on boot-up, and the presence of legacy devices at the endpoints could cause transient, low-end noise in the network.

Before you can connect a fiber optic cable to a **Gbic** port, you must install an SFP transceiver module that matches the requirements of your environment. The PoLRE switch supports 1000 Base-TX/SX/LX/EX/ZX/LHX, depending on which SFP transceiver module you install. The SFP modules must be ordered from NVT Phybridge Inc.

Installing the SFP Transceiver Modules

To Install an SFP Module:

1. Remove the SFP module from its protective packaging, but DO NOT remove the black protective cap. Small particles of dust can interfere with proper operation of the SFP module.



2. Open the locking mechanism on the SFP module by pulling it down over the black cap. When open, it can be used as a handle for inserting or removing the SFP module.
3. Determine which **Gbic** port will be installed with this SFP module.
 - For the upper port, **Gbic 1**, position the SFP module so that its handle is at the top, facing up.
 - For the lower port, **Gbic 2**, the SFP module must be turned upside down, with its handle at the bottom.

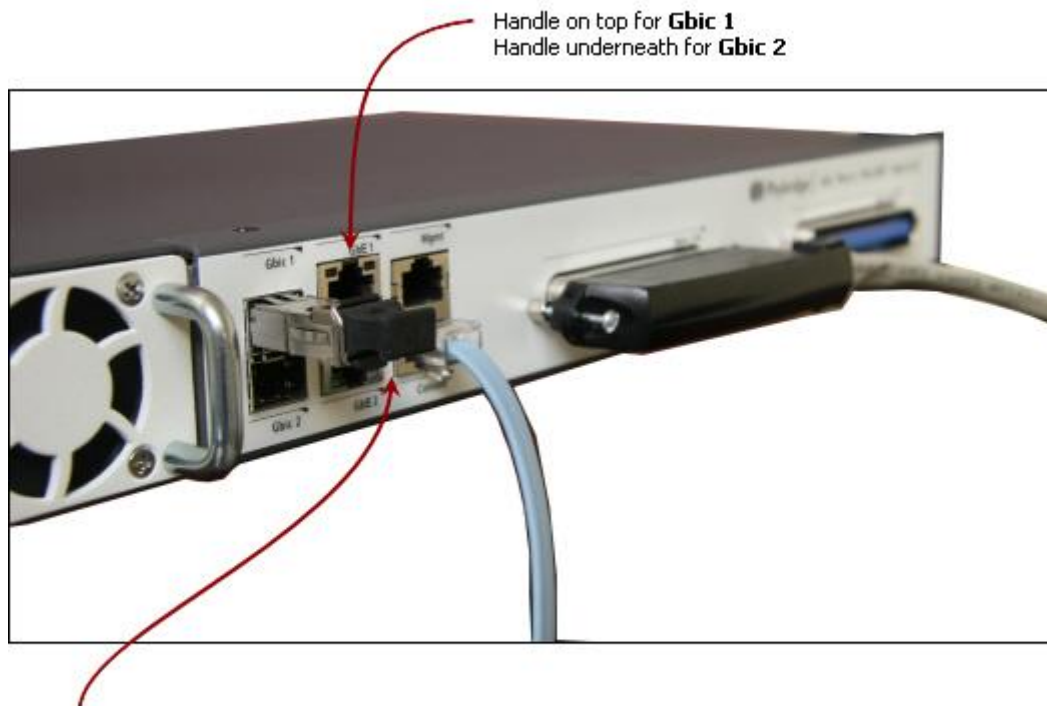

Install the SFP module into port **Gbic 1** or **Gbic 2**.

CAUTION: DO NOT remove the protective cap until you are ready to insert the fiber optic cable.

4. Align the SFP module in front of the desired **Gbic** port slot, and slide the module all the way in.



Note: When fully inserted, the SFP module extends slightly from the **Gbic** port.

5. Flip the locking mechanism up and over the black cap, pushing it back until it clicks into place.



CAUTION: DO NOT remove the black cap until you are ready to insert the fiber optic cable.

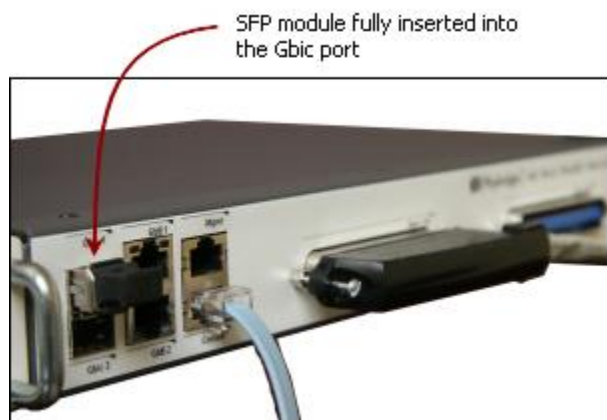

To Remove an SFP Module:

1. If required, remove the fiber optic cable from the SFP module.
2. Unlock the SFP module:
 - If the SFP module is in port **Gbic 1**, flip the handle down to unlock the module.
 - If the SFP module is in port **Gbic 2**, flip the handle up.
3. If required, remove the protective cap from the end of the SFP module.



WARNING: DO NOT look into the SFP connector when it is installed in a Gbic port, as the laser beam can cause serious eye injury.

4. Slide the SFP module out of the **Gbic** port, using its handle.



Note: The SFP module cannot be removed from the port if its protective cap is on.



Flip the handle down to unlock an SFP module in port **Gbic 1**.

Installing the Fiber Optic Cable

To connect the PoLRE switch to the uplink network switch or IP PBX using a fiber optic cable:

1. Remove the black protective cap from the SFP transceiver module.



WARNING: DO NOT look into the SFP connector when it is installed in a Gbic port, as the laser beam can cause serious eye injury.

2. Connect your fiber optic cable to port **Gbic 1** or **Gbic 2** on the front panel of the PoLRE switch.



Insert fiber optic cable into port **Gbic 1** or **Gbic 2**.



Note: Both ports can be used. If only one connection will be installed, use the port labelled **GbE 1**.



CAUTION: If you have already installed a copper LAN cable in port **GbE 1** to the right, you must connect the fiber optic cable to port **Gbic 2**. Likewise, if port **GbE 2** has been deployed, the fiber optic cable must go in port **Gbic 1**. Otherwise, the **GbE** port will not work.

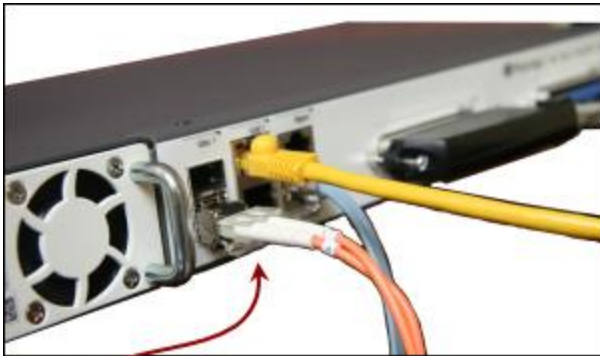

Fiber optic cable *must* go into **Gbic 2** if port **GbE 1** is deployed.

Connecting to Power

The PoLRE switch is powered through an AC Connection (see the next section). Another hardware configuration is available for Powershare purposes. This requires multiple PoLRE switches installed in a standard 19" equipment rack. For details, refer to Daisy-chaining PoLRE Switches for Powershare, page 34.

AC Connection

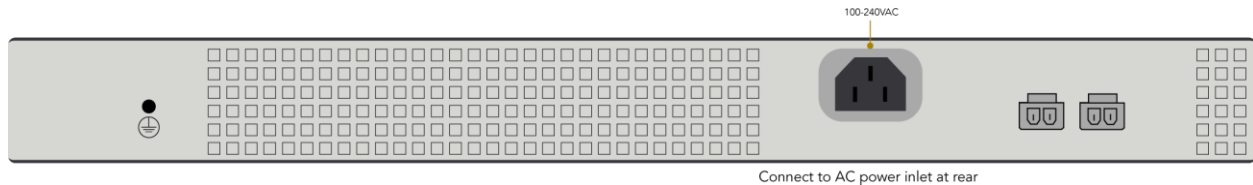

To Connect the PoLRE Switch to an AC Power Source:

1. Ensure that the power supply unit is fully inserted into its slot, and that its thumbscrew at the front is well tightened.
2. Connect the AC power cord to the AC power inlet located at the rear of the switch.
3. Plug the other end of the power cord into an AC power outlet (100-240 VAC, 50/60 Hz) with a protective earthing connection in good condition. For reliability purposes it is recommended that the PoLRE switch be powered from a dedicated mains outlet.



WARNING: Ensure that the switch is independently grounded with a wire from Ground securely attached to the ground lug at the rear of the switch. See ESD Procedure, page 18.



Note: The PoLRE switch will power up immediately and begin system status verification.

Multiple Switch Configurations

Multiple PoLRE switches can be installed together in the same equipment rack for power and load sharing between multiple PoLRE switches. A fully redundant ring can be created, providing redundant power to any switch that has a power failure.

Daisy-chaining PoLRE Switches for Powershare

Up to 4 PoLRE switches can be daisy-chained together for Powershare. They are connected in a ring using the DC In/Out connectors at the rear of the switch. If a power fault occurs on any switch in the ring, the others are able to share the load, and the affected switch continues to function normally.



CAUTION: Powershare Mode is not intended to be a permanent operating mode. If the power supply unit of a PoLRE switch should fail, you must replace it as soon as possible.

The illustration below shows how multiple PoLRE switches can be interconnected using the two DC In/Out connectors at the rear of each switch. Apply this illustration to your particular environment before continuing with the procedure that follows the illustration.



Note: This procedure requires that you have the following on hand:

- The additional PoLRE switches and their accessories, including the DC cables.
- At least one switch must be powered with an AC connection. Typically, all switches are AC

- Connect DC input (left) on one switch to to DC output (right) on the next.
- For a fully redundant ring, connect DC input on bottom switch to DC output on top switch.
- AC connected to all switches.

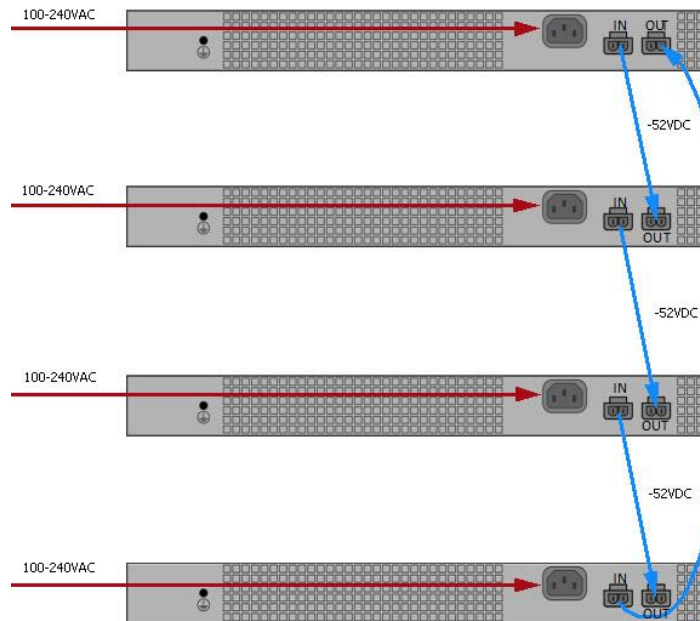

powered before you begin.

Daisy-Chaining PoLRE Switches for Powershare

To daisy-chain Multiple PoLRE Switches for Powershare:

1. Mount all PoLRE switches in the same equipment rack, with no more than 1U space between any two switches. Refer to Installing the Switch in a Rack, page 22.



Note: You can daisy-chain the switches together while they are up and running or power them up afterward.

2. Facing the rear of the switches, install the DC cables as follows:



Note: To fit properly, the DC cable must be inserted into the DC input/output connector with its hairpin clip on top.

- For the top switch, insert the first cable into the DC input connector on the left until it clicks into place. Bring the other end of the cable down to the next switch and connect to the DC output connector on the right.
- Continue in the same way for each pair of switches, connecting the DC input (left) connector on the upper switch to the DC output (right) connector on the lower switch.
- **Important:** For the bottom switch, the last cable from the DC input (left) connector goes up to the DC output (right) connector on the top switch. This is required to create a fully redundant ring.



Note: If you need to move a cable to a different DC connector on the PoLRE switch, press the hairpin clip at the top of the DC cable and pull the cable out.



Replacing the Power Supply Unit

If a power supply unit fails, you must replace it with a new power supply unit as soon as possible. If 2 or more daisy-chained switches are up and running, you can hot swap the PSU on one of them without bringing the system down.



CAUTION: The following procedure should be carried out only if you have a spare PSU to replace the failed PSU. Spare PSUs can be purchased from NVT Phybridge Inc.



Note: The power supply unit is removed and replaced from the front of the PoLRE switch.

To Remove the Power Supply Unit:

1. Loosen the thumbscrew on the left side of the power supply unit.
 2. Pull the power supply unit out from its housing using the handle on the right side.
-



CAUTION: Do not lift the PoLRE switch using the handle on the power supply unit. This handle is intended for removing and replacing the PSU only.



To Replace the Power Supply Unit:

1. Remove the new power supply unit from its packaging and align it so that its front panel is facing you, with the handle on the right side.
2. Lift the new power supply unit by its handle and slide it straight into the PSU housing on the left side of the PoLRE switch.
3. Push firmly on the power supply unit to insert its connector securely at the rear of the PoLRE switch.
4. Tighten the thumbscrew on the left side of the power supply unit. It should be finger tight only. **Do not use a tool to tighten it.**



PoLRE Switch Model 24-Port and 48-Port Model Technical Specifications

Description		Specification
Models		24-Port: Can drive up to 24 Phylink adapters 48-Port: Can drive up to 48 Phylink adapters
Dimensions		19 inches x 1U Without rack ears: 1.75" x 17.13" x 9.92" (HxWxD) 4.45cm x 43.5cm x 25.2 cm (HxWxD)
Weight		7.96 lb. (3.61 kg)
Unit		Aluminum
Mounting		Standalone or rack or shelf-mountable 2 brackets included for installation
Processor		Broadcom BCM56018 switch processor, 266MHz
Memory		32MB FLASH 64MB DDR SDRAM
Interfaces:	Downlink (PoE and IP to Adapter)	Model 24-Port: 1 RJ21 male telco connector (standard), 24 pairs used Model 48-Port: 2 RJ21 male telco connectors (standard), 48 pairs used Maximum distance: 1200' (365m) CAT3 UTP cable, 24 AWG Speed: 10Mb/s (full duplex) PoE power: 15 Watts
	Ethernet Uplink (Trunk IP)	Maximum 2 uplinks, each 1Gb/s (full duplex);, 2 RJ45 ports: 10/100/1000 Base-T autosensing, independent speed selection, Ethernet IEEE 802.3, CAT5e copper cable
	Management	1 LAN port (MGMT): RJ45, 10/100 Base-T autosensing, IEEE 802.3 1 UART console port: RJ45 to DB9 cable
Power Supply		Hot-Swappable Power Supply Unit Autosensing 100-240VAC, 50/60 Hz Power output: 500W max at 100VAC 1000W max at 240VAC
Power Consumption		Model 24-Port: 34.5W max Model 48-Port: 40W max
Power Injection (PoE)		DC voltage: -58VDC Endpoint devices must be compliant with IEEE 802.3af
Power Load Sharing		2 male connectors (rear), DC IN and DC OUT: 48VDC to 58VDC
Description		Specification
Fans		2 on switch, 2 on power supply unit
Operating Temperature		14°F to 122°F (-10°C to 50°C)

PoLRE Switch Model 24-Port and 48-Port Model Technical Specifications

Storage Temperature	-4°F to 158°F (-25°C to 70°C)
Humidity	10% to 95% (non-condensing) at 95°F (35°C)
MTBF	50,000 hours (24 Port and 48 Port) and 10 years (power supply unit)

Phylink Adapter Technical Specifications

Description		Specification
Dimensions		0.71" x 1.1" x 2.56" (HxWxD) (1.8cm x 2.8cm x 6.5cm (HxWxD))
Weight		0.78 oz. (22 g)
Enclosure		ABS (AF-312B)
Mounting		Inline between the CAT5e cable (to IP endpoint) and the CAT3 cable (to RJ11 jack)
Interfaces	PoLRE side:	1 RJ11 port: CAT3 unshielded single twisted pair cable. Between the wall plate and adapter, you can reuse the existing silver satin when doing a DNIC/POTS displacement.
	Ethernet side: for IP endpoint device	1 RJ45 port: 10/100 Base-T autosensing, IEEE 802.3af 10 Mb connection to IP end device
Power injection (PoE)		DC voltage on RJ45 port: -54V max -37V when 1200' (365m) away from PoLRE switch Powers Class 1, Class 2 and some Class 3 IEEE 802.3af compliant IP devices
Operating temperature		32°F to 104°F (0°C to 40°C)
Storage Temperature		4°F to 158°F (-25°C to 70°C)
Humidity		10% to 95% (non-condensing) at 95°F 35°C

5. Compliance and Environmental Information

All the compliance and environmental information is available on our website www.nvtphybridge.com

6. Acronyms

Acronym	Definition
AC	Alternating Current
CLI	Command Line Interface
DC	Direct Current
GUI	Graphical User Interface
IP	Internet Protocol
IPT	IP Telephony
LED	Light Emitting Diode
NMS	Network Management System
OAM&P	Operations, Administration, Maintenance and Provisioning
PoE	Power over Ethernet
PoLRE	Power over Long Reach Ethernet
PSE	Power Sourcing Equipment
PSU	Power Supply Unit
RAM	Random Access Memory
SFP	Small Form-factor Pluggable
SNMP	Simple Network Management Protocol
VLAN	Virtual Local Area Network

Index

- 2-wire network infrastructure
 - connection to, 26
- AC power connection, 33
- acronyms, 41
- ALARM LED, 10
- audience, i
- cable
 - CAT3, for Phylink adapter, 24
 - CAT5e copper, for GbE port, 28
 - ethernet, for Phylink adapter, 24
 - fiber optic, for Gbic port, 29
 - serial, for Console, 27
- components
 - care of, 20
 - internal, 4
- Console port, 9
 - connection, 27
- customer service, i
- daisy-chaining multiple switches, 34
- dimensions
 - Phylink adapter, 12
 - PoLRE switch, 4
- distance requirements, 14
- document conventions, ii
- downlink distance
 - requirements, 14
- downlink ports, 7
 - connection, 26
- environment, operating and storage
 - PoLRE switch, 4
- ESD procedure, 18
- Ethernet port
 - Phylink adapter, 12
- FAULT LED, 10
- fiber optic cable, 29
- front panel, 3
- GbE port connection, 28
 - Gbic port connection, 29
 - ground lug, 18
 - installation, 16
 - 2-wire network connection, 26
 - AC power connection, 33
 - Console connection, 27
 - fiber optic cable, 29
 - GbE port, 28
 - Gbic port, 29
 - IP PBX connection, 28
 - multiple switch configurations, 34
 - of PoLRE switch in rack, 22
 - overview of steps, 21
 - Phylink adapter, 24
 - power supply unit, 36
 - Powershare, 35
 - requirements, 14
 - safety warnings, 19
 - SFP module, 29
 - IP PBX, connection to, 28
 - LEDs, 12
 - Management ports
 - Console, 9
 - out-of-band, 8
 - multiple switch configurations, 34
 - daisy-chaining, 34
 - Phylink adapter
 - dimensions, 12
 - hardware description, 11
 - installation, 24
 - product numbers, 11
 - technical specifications, 39
 - PoLRE switch
 - components, care of, 20
 - dimensions, 4
 - front view, 3
 - installation, 16
 - installing in a rack, 22
 - internal components, 4
 - operating environment, 4
 - overview, 2

- power supply unit, 5
- product numbers, 4
- product package, 13
- rear view, 4
- resetting, 10
- returning, i
- RJ11 port, 11
- RJ45 port, 11
- storage environment, 4
- technical specifications, 38
- ports
 - Console, 9
 - Console, connection, 27
 - downlink, 7
 - Management, out-of-band, 8
 - RJ11, on PoLRE switch, 11
 - RJ45, on PoLRE switch, 11
 - uplink, 6
- power
 - AC connection, 33
 - distance requirements, 14
- power supply unit, 5
 - installation, 36
 - status indicators, 10
- Powershare, 34
- product numbers
 - Phylink adapter, 11
 - PoLRE switch, 4
- product package, 13
- rackmount installation, 22
 - safety warnings, 23
- rear panel, 4
- redundancy
 - Powershare, 34
- removal
 - SFP module, 31
- replacement
 - power supply unit, 36
 - SFP module, 29
- replacement of legacy devices, 24
- requirements
 - distance, 14
 - downlink distance, 14
 - installation, 16
 - size, 14
 - ventillation, 14
- Reset button, 10
- returning a PoLRE switch, i
- RUN LED, 10
- safety warnings, 18
 - rackmount installation, 23
- service, i
- SFP module
 - installation, 29
 - removal, 31
- size requirements, 14
- status indicators, 10
- system status, 10
- technical specifications
 - Phylink adapter, 39
 - PoLRE switch, 38
- technical support, i
- uplink ports, 6
- ventillation requirements, 14
- warranty, i

