

snom

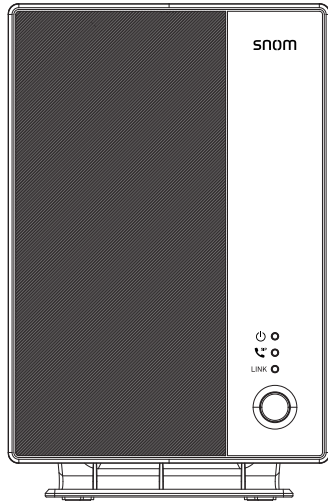

M500

Multi-cell SIP DECT Base Station

Quick Installation Guide

Important Safety Information



This symbol is to alert you to important operating or servicing instructions that may appear on the product or in this user's manual. Always follow basic safety precautions when using this product to reduce the risk of injury, fire, or electric shock.

Important Safety Instructions

When using your telephone equipment, basic safety precautions should always be followed to reduce the risk of fire, electric shock and injury, including the following:

1. This product should be installed by a qualified technician.
2. This product should only be connected to the host equipment and never directly to the network such as Public Switch Telephone Network (PSTN) or Plain Old Telephone Services (POTS).
3. Read and understand all instructions.
4. Follow all warnings and instructions marked on the product.
5. Unplug this product from the wall outlet before cleaning. Do not use liquid or aerosol cleaners. Use a damp cloth for cleaning.
6. Do not use this product near water such as near a bath tub, wash bowl, kitchen sink, laundry tub or swimming pool, or in a wet basement or shower.
7. Do not place this product on an unstable table, shelf, stand or other unstable surfaces.
8. Slots and openings in the back or bottom of the base station and handset are provided for ventilation. To protect them from overheating, these openings must not be blocked by placing the product on a soft surface such as a bed, sofa or rug. This product should never be placed near or over a radiator or heat register. This product should not be placed in any area where proper ventilation is not provided.
9. This product should be operated only from the type of power source indicated on the marking label. If you are not sure of the type of power supplied at the premises, consult your dealer or local power company.
10. Do not allow anything to rest on the power cord. Do not install this product where the cord may be walked on.
11. Never push objects of any kind into this product through the slots in the base station or handset because they may touch dangerous voltage points or create a short circuit. Never spill liquid of any kind on the product.

12. To reduce the risk of electric shock, do not disassemble this product, but take it to an authorized service facility. Opening or removing parts of the base station or handset other than specified access doors may expose you to dangerous voltages or other risks. Incorrect reassembling can cause electric shock when the product is subsequently used.
13. Do not overload wall outlets and extension cords.
14. Unplug this product from the wall outlet and refer servicing to an authorized service facility under the following conditions:
 - A. When the power supply cord or plug is damaged or frayed.
 - B. If liquid has been spilled onto the product.
 - C. If the product has been exposed to rain or water.
 - D. If the product does not operate normally by following the operating instructions. Adjust only those controls that are covered by the operation instructions. Improper adjustment of other controls may result in damage and often requires extensive work by an authorized technician to restore the product to normal operation.
 - E. If the product has been dropped and the telephone base and/or handset has been damaged.
 - F. If the product exhibits a distinct change in performance.
15. Avoid using a telephone (other than cordless) during an electrical storm. There is a remote risk of electric shock from lightning.
16. Do not use the telephone to report a gas leak in the vicinity of the leak. Under certain circumstances, a spark may be created when the adapter is plugged into the power outlet, or when the handset is replaced in its cradle. This is a common event associated with the closing of any electrical circuit. The user should not plug the phone into a power outlet, and should not put a charged handset into the cradle, if the phone is located in an environment containing concentrations of flammable or flame-supporting gases, unless there is adequate ventilation. A spark in such an environment could create a fire or explosion. Such environments might include: medical use of oxygen without adequate ventilation; industrial gases (cleaning solvents; gasoline vapors; etc.); a leak of natural gas; etc.
17. Only put the handset of your telephone next to your ear when it is in normal talk mode.
18. The power adapters are intended to be correctly oriented in a vertical or floor mount position. The prongs are not designed to hold the plug in place if it is plugged into a ceiling, under-the-table or cabinet outlet.
19. Use only the power cord indicated in this manual.

20. For pluggable equipment, the socket-outlet shall be installed near the equipment and shall be easily accessible.
21. In wall mounting position, make sure to mount the telephone base on the wall by aligning the eyelets with the mounting studs of the wall plate. Then slide the telephone base down on both mounting studs until it locks into place. Mount the device only at heights not exceeding 2 meters. Refer to the full installation instructions in the User Manual.
22. CAUTION: Keep small metallic objects such as pins and staples away from the handset receiver.
23. WARNING: The product included (ITE) in this manual is to be connected only to PoE networks without routing to the outside plant.

SAVE THESE INSTRUCTIONS

<p>Power requirements</p> 	<p>Power over Ethernet (PoE): IEEE 802.3af supported, class 3 If PoE not available, power adapter (sold separately): NBS12E050200UV Input: 100-240V AC 50/60Hz Output: 5.0V DC @ 2A</p>
--	--

For cUL compliance only

Mesures de sécurité importantes



Ce symbole vous alertera d'informations importantes ou d'instructions d'entretien pouvant apparaître dans ce guide d'utilisation. Respectez toujours les mesures de sécurité et de sécurité de base lorsque vous utilisez ce produit, afin de réduire les risques de blessures, d'incendie, ou d'électrocution.

Mesures de sécurité importantes

Afin de réduire les risques d'incendie, de blessures corporelles ou d'électrocution, suivez toujours ces mesures préventives de base lorsque vous utilisez votre téléphone



1. Cet appareil doit être installé par un technicien qualifié.
2. Cet appareil doit être branché à un équipement hôte et jamais branché à un réseau, tel qu'un réseau PSTN publique ou un réseau téléphonique standard (POTS).

3. Lisez et comprenez bien toutes les instructions.
4. Observez toutes les instructions et mises en garde inscrites sur l'appareil.
5. Débranchez ce téléphone de la prise murale avant de le nettoyer. N'utilisez pas de nettoyeurs liquides ni en aérosol. N'utilisez qu'un chiffon doux et légèrement humecté.
6. N'utilisez pas ce produit près de l'eau, tel que près d'un bain, d'un lavabo, d'un évier de cuisine, d'un bac de lavage ou d'une piscine, ou dans un sous-sol humide ou sous la douche.
7. Ne déposez pas ce téléphone sur un chariot, support ou table chancelants. L'appareil pourrait tomber et être sérieusement endommagé.
8. Le boîtier de l'appareil est doté de fentes et d'ouvertures d'aération situées à l'arrière ou en dessous. Afin d'empêcher la surchauffe, ces ouvertures ne doivent pas être obstruées en plaçant l'appareil sur un lit, divan, tapis ou autre surface similaires. Ne placez pas cet appareil à proximité d'un élément de chauffage ni d'une plinthe électrique. De plus, ne l'installez pas dans une unité murale ou un cabinet fermé qui ne possède pas d'aération adéquate.
9. Ne faites fonctionner cet appareil qu'avec le type d'alimentation indiqué sur les étiquettes de l'appareil. Si vous ne connaissez pas le voltage de votre maison, consultez votre marchand ou votre fournisseur d'électricité.
10. Ne déposez rien sur le cordon d'alimentation. Installez cet appareil dans un endroit sécuritaire, là où personne ne pourra trébucher sur la ligne d'alimentation ni le cordon téléphonique modulaire.
11. N'insérez jamais d'objets à travers les fentes et ouvertures de cet appareil, car ils pourraient toucher à des points de tension dangereux ou court-circuiter des pièces, ce qui constituerait un risque d'incendie ou d'électrocution. N'échappez pas de liquides dans l'appareil.
12. Afin de réduire les risques d'électrocution, ne démontez pas l'appareil, mais apportez-le plutôt à un centre de service qualifié s'il doit être réparé. En enlevant le couvercle, vous vous exposez à des tensions dangereuses ou autres dangers similaires. Un remontage inadéquat peut être à l'origine d'une électrocution lors d'une utilisation ultérieure de l'appareil.
13. Ne surchargez pas les prises de courant ni les rallonges électriques, car ceci peut constituer un risque d'incendie ou d'électrocution.
14. Débranchez cet appareil de la prise de courant et communiquez avec le département de service à la clientèle de Snom dans les cas suivants:
 - A. Lorsque le cordon d'alimentation est endommagé ou écorché.
 - B. Si du liquide a été échappé dans l'appareil.

- C. Si l'appareil a été exposé à une source d'humidité telle que la pluie ou l'eau.
 - D. Si l'appareil ne fonctionne pas normalement en suivant les directives du guide. N'ajustez que les commandes couvertes dans le guide d'utilisation, car un mauvais réglage de celles-ci peut être à l'origine de dommages, ce qui nécessiterait des réparations considérables pour remettre l'appareil à son état de fonctionnement normal.
 - E. Si l'appareil a été échappé ou son boîtier, endommagé.
 - F. Si le produit affiche une nette diminution de sa performance.
15. Évitez d'utiliser un téléphone (autre qu'un sans fil) pendant un orage. Les éclairs peuvent être à l'origine d'une électrocution.
 16. N'utilisez pas le téléphone pour rapporter une fuite de gaz à proximité de celle-ci. Sous certaines circonstances, une intéincelle pourrait survenir lorsque l'adaptateur est branché à une prise de courant, ou lorsque le combiné est déposé sur le combiné. Ceci est un événement commun associé avec la fermeture d'un circuit électrique. L'utilisateur ne devrait pas brancher le téléphone dans une prise de courant, et ne devrait pas déposer le combiné chargé sur le socle, si le téléphone se trouve dans un environnement ou la concentration de gaz inflammables, sans ventilation adéquate. Une étincelle dans ces endroits pourrait provoquer un incendie ou une explosion. Ces environnements pourraient être l'utilisation médicale de l'oxygène sans ventilation adéquate; le gaz industriel (dissolvants, vapeurs d'essence, etc.); une fuite de gaz naturel, etc.
 17. Placez uniquement le combiné de votre appareil près de votre oreille lorsqu'il est en mode de conversation normal.
 18. Les adaptateurs sont conçus pour être orientés en position verticale ou en position horizontale sur le plancher.
 19. N'utilisez que cordon d'alimentation et les piles indiquées dans ce guide d'utilisation.
 20. Pour les **PRODUITS À BRANCHER À UNE PRISE DE COURANT**, la prise de courant doit être installée près du produit, afin d'assurer une accessibilité sécuritaire à la prise de courant.
 21. En position de montage mural, assurez-vous de monter le socle du téléphone sur le mur en alignant les oeilletons avec les goujons de fixation de la plaque murale. Ensuite, faites glisser le socle vers le bas sur les deux goujons de fixation jusqu'à ce qu'il se verrouille en place. Ne fixez l'appareil qu'à des hauteurs ne dépassant pas 2 mètres. Reportez-vous aux instructions complètes dans la section Installation dans ce guide d'utilisation.

22. MISE EN GARDE : Éloignez les petits objets métalliques tels que les broches de l'écouteur du combiné.
23. AVERTISSEMENT : Le produit inclus (ITE) dans ce guide doit être connecté uniquement aux réseaux PoE sans être acheminé vers l'installation extérieure.

CONSERVEZ CES INSTRUCTIONS

<p>Exigences en matière d'alimentation</p>  	<p>Alimentation par Ethernet (PoE) : IEEE 802.3af supporté, classe 3</p> <p>Si PoE non disponible, adaptateur d'alimentation (vendu séparément) : NBS12E050200UV Entrée : 100-240V AC 50/60Hz</p> <p>Sortie : 5,0 V CC @ 2 A</p>
---	--

Compliance

FCC part 15

This device complies with Part 15 of the FCC rules. Operation is subject to the following two conditions: (1) This device may not cause harmful interference, and (2) this device must accept any interference received, including interference that may cause undesired operation.

This equipment has been tested and found to comply with the limits for a Class A digital device, pursuant to Part 15 of the FCC Rules. These limits are designed to provide reasonable protection against harmful interference when the equipment is operated in a commercial environment. This equipment generates, uses, and can radiate radio frequency energy and, if not installed and used in accordance with the instruction manual, may cause harmful interference to radio communications. Operation of this equipment in a residential area is likely to cause harmful interference in which case the user will be required to correct the interference at the user's expense.

Privacy of communications may not be ensured when using this phone.

Warning: Changes or modifications to this equipment not expressly approved by the party responsible for compliance could void the user's authority to operate the equipment.

Caution: To maintain the compliance with the FCC's/ISED's RF exposure guideline, place the base unit at least 20 cm from nearby persons.

Industry Canada

This Class A digital apparatus complies with Canadian requirements: CAN ICES-3 (A)/NMB-3(A). Cet appareil numérique de la classe A est conforme à la norme CAN ICES-3 (A)/NMB-3(A) du Canada.

This device contains licence-exempt transmitter(s)/receiver(s) that comply with Innovation, Science and Economic Development Canada's licence-exempt RSS(s).

Operation is subject to the following two conditions: (1) this device may not cause interference, and (2) this device must accept any interference, including interference that may cause undesired operation of the device.

Privacy of communications may not be ensured when using this telephone.

The term "IC:" before the certification/registration number only signifies that the Industry Canada technical specifications were met.

About this Guide

This quick installation guide provides a reference for the external features of the base station and basic installation instructions.

For customer service or product information, visit our website at www.snomamericas.com.

Parts Checklist

Your package contains the following items. Save your sales receipt and original packaging in the event warranty service is necessary.

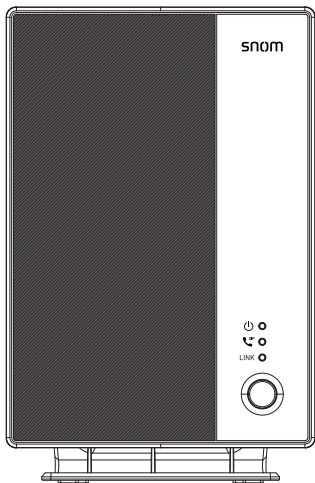

Base Station

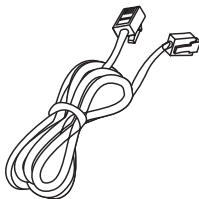

Ethernet cable



Quick Reference Guide

Base station external features - Front view

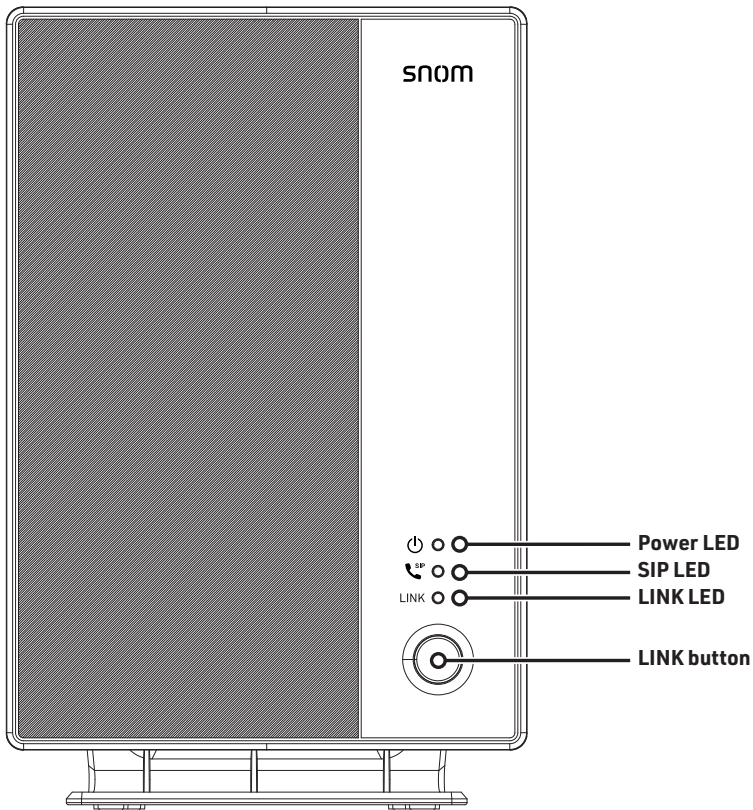

Quick Reference Guide

Base station external features - Rear view

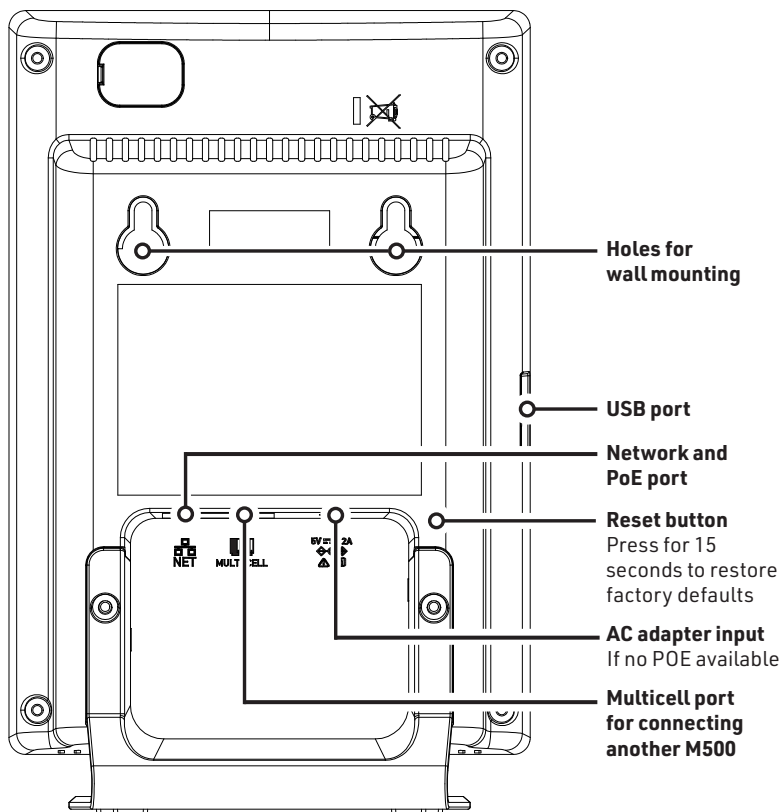

Status Indicators on the Base Station

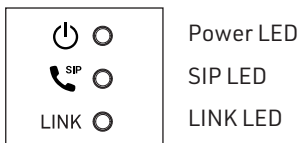

LED	Color	Pattern	Description
Power	Green	Steady	<ul style="list-style-type: none"> • Base station just powered ON and proceeding to IP retrieval • Power has been On and IP is assigned to the base station • ON for five seconds after the confirmation of system deregistration
		OFF	<ul style="list-style-type: none"> • Base station is not powered up
		Slow flash	<ul style="list-style-type: none"> • During deskset/handset registration, i.e. subscription mode • Power has been On and DHCP has been enabled, but no IP is assigned to the base station • Toggles with the SIP LED for negotiating or checking with provisioning server
		Quick flash	<ul style="list-style-type: none"> • Ready to deregister deskset/handset • Toggles with SIP LED for base station/deskset/handset firmware upgrade or configuration import in progress

Status Indicators on the Base Station

LED	Color	Pattern	Description
SIP	Green	Steady	<ul style="list-style-type: none"> All enabled SIP accounts are registered; displayed on a Primary or Single cell base station ON for five seconds after the confirmation of system deregistration
		Slow Flash	<ul style="list-style-type: none"> During deskset/handset registration, i.e. subscription mode Toggles with the power LED for negotiating or checking with provisioning server
		Quick Flash	<ul style="list-style-type: none"> Ready to deregister deskset/handset Toggles with the Power LED for base station/deskset/handset firmware upgrade or configuration import in progress
	Red	Slow Flash	<ul style="list-style-type: none"> At least one enabled SIP account is deregistered; displayed on a Primary or Single cell base station
	Red & Green	Slow Flash	<ul style="list-style-type: none"> Toggles red and green within the SIP LED for "Primary base" mode during base selection mode
	Orange	Steady	<ul style="list-style-type: none"> All enabled SIP accounts are registered; displayed on a Secondary base station
Slow Flash		<ul style="list-style-type: none"> At least one enabled SIP account is deregistered; displayed on a Secondary base station 	

Status Indicators on the Base Station

LED	Color	Pattern	Description
LINK	Green	Steady	<ul style="list-style-type: none"> This base station is connected with deskset(s)/ handset(s) and registered base stations (if any) ON for five seconds after the confirmation of system deregistration
		Slow Flash	<ul style="list-style-type: none"> During deskset/handset registration, i.e. subscription mode; This base station is connected with registered base station(s) (if any), but not connected with any registered deskset/handset at the moment
		Quick Flash	<ul style="list-style-type: none"> Ready to deregister deskset/handset
	Red	Steady	<ul style="list-style-type: none"> This base station is registered and connected with other base stations, but the M500 system has no record of deskset/handset
		Slow Flash	<ul style="list-style-type: none"> This base station cannot connected with other registered base station(s) in the same network, whether or not the base station is connected to deskset(s)/handset(s)
		Quick Flash	<ul style="list-style-type: none"> This base station cannot find the master base unit; or the master base unit is down
	Red & Green	Slow Flash	<ul style="list-style-type: none"> Toggles red and green within the LINK LED for "Secondary base" mode during base selection mode
	Orange	Slow Flash	<ul style="list-style-type: none"> This Base station is a standalone base unit that is not registered with any Deskset/handset or base station
	Orange & Green	Slow Flash	<ul style="list-style-type: none"> Toggles orange and green within the LINK LED for "Factory reset without reboot" during base selection mode

Base Station Installation

This section assumes that your network infrastructure is established and that your IP PBX phone service has been ordered and configured for your location.

You can power the base station using Power over Ethernet (PoE) from your network or using a power adapter (sold separately). The base station requires PoE Class 3.

If you are not using PoE, install the base station near a power outlet not controlled by a wall switch. The base station can be placed on a flat surface or mounted on a wall in a vertical or horizontal orientation.

Avoid placing the base station too close to:

- Communication devices such as television sets, DVD players, or other cordless telephones
- Excessive heat sources
- Noise sources such as a window with traffic outside, motors, microwave ovens, refrigerators, or fluorescent lighting
- Excessive dust sources such as a workshop or garage
- Excessive moisture
- Extremely low temperature
- Mechanical vibration or shock such as on top of a washing machine or work bench

Note: For cordless accessory installation, see the M55 SIP DECT Handset Quick Installation Guide or the M58 SIP DECT Deskset Quick Installation Guide.

Facility without network infrastructure

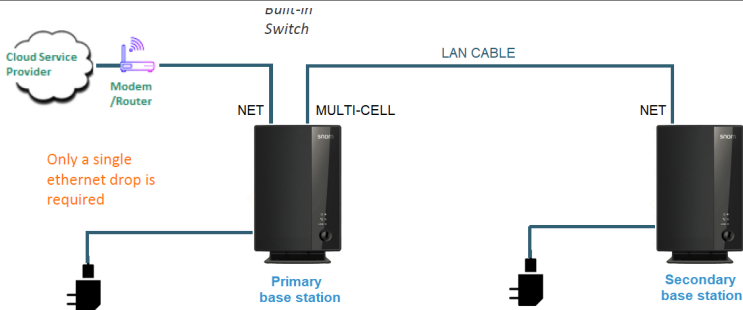

Facility with network infrastructure

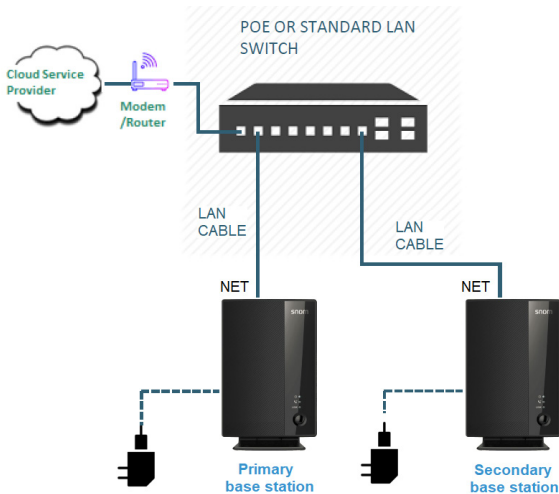

Connecting the base station

The base station can be operated with Power over Ethernet (PoE) provided via the network cable or, if PoE is not available in your network, with the separately available 5V DC power adapter.

Plug the Ethernet (network) cable into the RJ45 connector labeled "NET", and plug the other end into the network side to establish a data link. If PoE is not available, insert the plug of the power supply into the connector labeled "5V DC" and hook up the plug to the wall outlet.

The second RJ45 connector, labeled "MULTI-CELL", is for daisy-chaining further M500 base stations without the need for a second Ethernet connection line. Up to six M500 base stations can be connected for multi-cell operation.

IMPORTANT INFORMATION

1. Use only a compatible Snom power adapter (model number NBS12E050200UV). To order a replacement power adapter, visit our website at www.snomamericas.com.
2. The power adapter is intended to be correctly oriented in a vertical or floor mount position. The prongs are not designed to hold the plug in place if it is plugged into a ceiling, under-the-table or cabinet outlet.

Mounting the base station on a wall

1. Unscrew the foot stand, and remove it from the base station.
2. Install two mounting screws on the wall. Choose screws with heads larger than 5 mm (3/16 inch) in diameter (1 cm / 3/8 inch diameter maximum). The screw centers should be 60 mm (2 3/8 inches) apart vertically or horizontally. Tighten screws until only 3 mm (1/8 inch) of the screws are exposed.

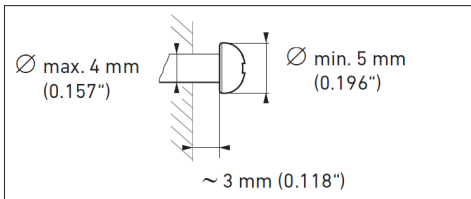

Mount the device only at heights not exceeding 2 meters.

3. Connect the Ethernet cable and power as described in "Base Station Installation" on page 15-16.
4. Place the base station over the mounting screws.

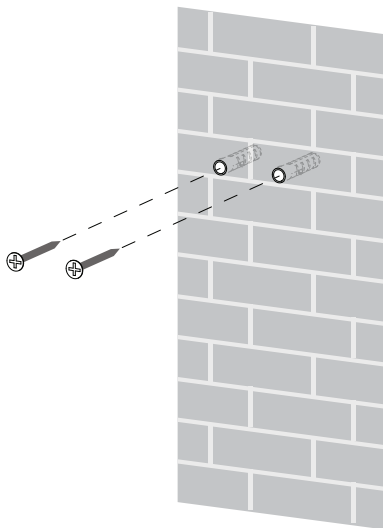
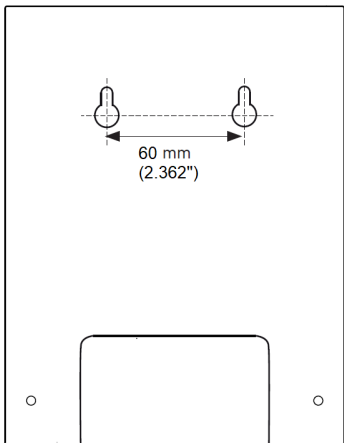

Maintenance

Taking care of your product

- Your base station contains sophisticated electronic parts, so you must treat it with care.
- Avoid rough treatment.
- Save the original packing materials to protect your product if you ever need to ship it.

Avoid water

- You can damage your base station if it gets wet. Do not use cordless accessories in the rain, or handle them with wet hands. Do not install the base station near a sink, bathtub or shower.

Electrical storms



- Electrical storms can sometimes cause power surges harmful to electronic equipment. For your own safety, take caution when using electric appliances during storms.

Cleaning your product

- Your product has a durable plastic casing that should retain its luster for many years. Clean it only with a soft cloth slightly dampened with water or a mild soap.
- Do not use excess water or cleaning solvents of any kind.

Remember that electrical appliances can cause serious injury if used when you are wet or standing in water. If the telephone base should fall into water, **DO NOT RETRIEVE IT UNTIL YOU UNPLUG THE POWER CORD FROM THE WALL**, then pull the unit out by the unplugged cord.

Technical Specifications

RF frequency band	1921.536-1928.448 MHz
Channels	5
Operating temperature	32-104 °F (0-40 °C)
Power requirements  	Power over Ethernet (PoE): IEEE 802.3af supported, class 3 If PoE not available, power adapter (sold separately): NBS12E050200UV Input: 100-240V AC 50/60Hz Output: 5.0V DC @ 2A
Connectors	Two 10/100 Mbps Ethernet RJ-45 ports One USB 2.0 type A

