



DECT (W710D+W610D) User Manual

Version: 1.0.0 | Date: 2024/07/13

Directory

Directory	2
1 Safety Instructions	8
1.1 Safety Instructions	8
1.2 Battery Warning	9
2 Overview	10
2.1 Summary	10
2.2 Specification Introduction	10
2.2.1 W710D Specification Introduction	10
2.2.2 W610D Specification Introduction	11
3 Installation	12
3.1 Packing Contents	12
3.1.1 W710D Packing Contents	12
3.1.2 W610D Packing Contents	12
3.2 Install W710D	13
3.3 Install W610D	14
3.3.1 Installing the battery	14
3.3.2 Battery Replacement	15
3.3.3 Connect the charging base	17
3.3.4 Installing belt clip	17
4 Introduction to the User	18
4.1 Instruction of Keypad	18
4.1.1 Instruction of Keypad for W710D	18
4.1.2 Instruction of Keypad for W610D	19
4.2 W610D power on/off	21
4.3 Language settings	21
4.4 Country/Region Settings	22
4.5 W610D Standby Interface	23
4.6 W610D Menu	24

4.7 Device status	25
4.8 Access W710D Webpage	26
4.8.1 Get IP Address	26
4.8.2 Access Webpage	26
4.9 W710D SIP Setting	26
5 Terminal Management	28
5.1.1 W710D Select Country/Region	28
5.1.2 Set PIN code for W710D	28
5.2 W610D connection network	28
5.3 Terminal Management	29
5.4 W710D Configuration Management	30
6 W610D Call Features	31
6.1 Using Handset / Hands-free Speaker / Headset	31
6.2 Initiate a call	31
6.2.1 Initiate a call	31
6.2.2 Call through function keys	32
6.2.3 Emergency call	32
6.2.4 Redial	33
6.2.5 Callback	34
6.2.6 Anonymous call	34
6.2.7 Hotline	34
6.3 Answer incoming calls	35
6.3.1 Manual answering	35
6.3.2 Auto Answer	35
6.4 Reject incoming calls	36
6.4.1 Manual rejection	36
6.4.2 Ban Anonymous Call	36
6.4.3 DND	36
6.5 End Call	37
6.6 Dial Query	37
6.7 Mute	37

6.7.1 Mute the call	37
6.7.2 Ringing Mute	38
6.8 Call Hold/Resume	38
6.9 Call forwarding	38
6.10 Call Transfer	39
6.10.1 Blind Transfer	39
6.10.2 Semi-Attended Transfer	39
6.10.3 Attended Transfer	40
6.11 Call Waiting	40
6.12 Conference	40
6.12.1 Local Conference	41
6.12.2 Network Conference	41
7 W610D Advanced Call Feature	43
7.1 Call Park	43
7.2 Intercom	44
7.2.1 Make Intercom Call	44
7.2.2 Answer Intercom Call	45
7.3 Message	45
7.3.1 SMS	45
7.3.2 Voice Mail	46
8 Phonebook	48
8.1 Local phonebook	48
8.1.1 Add/edit/delete contacts	48
8.1.2 Add/Edit/Delete Groups	48
8.1.3 View/Add/Delete Contacts	49
8.2 Cloud Contacts	49
8.2.1 Configure Cloud Contacts	50
8.2.2 Download cloud phone book	50
8.3 LDAP Contacts	50
8.3.1 Configure an LDAP phone book	50
8.3.2 Download the LDAP phone book	50

8.4 Blocked List	50
8.5 Allowed List	51
9 Call history	52
10 Advanced Features	53
10.1 Time Plan	53
10.1.1 W710D Time Plan	53
10.1.2 W610D Time Plan	54
10.2 Action Plan	54
10.3 Maintenance	55
10.3.1 W710D Configuration File	55
10.3.2 Upgrade	56
10.3.3 Auto Provision	60
11 W610D preference settings	63
11.1 Time Setting	63
11.2 Screen Setting	64
11.2.1 Backlight	64
11.2.2 Screensaver	64
11.2.3 Sleep	64
11.3 Audio Setting	65
11.3.1 Ringing Tone	65
11.3.2 Voice Volume Setting	65
11.4 Greeting Words settings	65
12 Function Keys	66
13 W710D Network Settings	70
13.1 Ethernet Settings	70
13.2 Network Mode	71
13.3 Web Server Type Settings	71
13.4 VPN	72
13.5 VLAN	73
14 W610D Connecting Peripherals	75

14.1 USB flash drive	75
14.2 Wired Headset	75
14.3 PTT Headset	75
14.3.1 PTT Headset Side key	76
14.3.2 PTT Headset Speed Dial key	76
14.4 Bluetooth Headset	77
15 Security	78
15.1 W610D Menu Password	78
15.2 W710D webpage password	78
15.3 W610D keyboard Password	78
15.4 W710D Web Filter	79
15.5 W710D Mutual Authentication	80
15.6 W710D Firewall	81
16 Troubleshooting	84
16.1 Obtain System Information	84
16.1.1 Obtain Information for W710D	84
16.1.2 Obtain system information for W610D	84
16.2 W610D power on/off	85
16.3 Reboot	85
16.4 Reset Device to Factory Default	85
16.5 Screenshot	86
16.6 Network Packets Capture	86
16.7 Get Log Information	87
16.8 W610D USB/USB drive upgrade	87
16.9 Common Trouble Cases	88
17 Appendix	90
17.1 Appendix I - W610D Key Icons	90
17.2 Appendix II - W610D Status and Notification Icons	90
17.3 Appendix III - W610D LED State Definition	92
17.4 Appendix IV - W610D Menu Icons	92
17.5 Appendix V - W610D Keyboard Character Query Table	93

17.6 Appendix VI - W710D LED Status Definition95

1 Safety Instructions

1.1 Safety Instructions

Please read the following safety notices before installing or using this unit. They are crucial for the safe and reliable operation of the device.

- Please use the external power supply that is included in the package. Other power supply may cause damage to the device and affect the behavior or induce noise.
- Before using the external power supply in the package, please check the home power voltage. Inaccurate power voltage may cause fire and damage.
- Please do not damage the power cord. If power cord or plug is impaired, do not use it because it may cause fire or electric shock.
- Do not drop, knock or shake the device. Rough handling can break internal circuit boards.
- This phone is designed for indoor use. Do not install the device in places where there is direct sunlight. Also do not put the device on carpets or cushions. It may cause fire or breakdown.
- Avoid exposure the device to high temperature or below 0°C or high humidity.
- Avoid wetting the unit with any liquid.
- Do not attempt to open it. Non-expert handling of the device could damage it. Consult your authorized dealer for help, or else it may cause fire, electric shock and breakdown.
- Do not use harsh chemicals, cleaning solvents, or strong detergents to clean it. Wipe it with a soft cloth that has been slightly dampened in a mild soap and water solution.
- When lightning, do not touch power plug, it may cause an electric shock.
- Do not install this phone in an ill-ventilated place. You are in a situation that could cause bodily injury. Before you work on any equipment, be aware of the hazards involved with electrical circuitry and be familiar with standard practices for preventing accidents.

1.2 Battery Warning

- To prevent the battery pack from leaking, overheating and catching fire. Please observe the following precautions:
- Soft aluminum packaging foil is easily damaged by sharp edged parts such as nickel sheets, pins and needles.
- Do not hit the battery pack with any sharp parts.
- Do not immerse the battery pack in water or seawater.
- Do not use and place the battery pack near heat sources such as fire or heaters.
- Do not reverse the positive and negative poles.
- Do not connect the battery pack to the power outlet.
- Do not throw the battery pack into fire or heat.
- Do not connect the positive and negative poles directly to metal objects such as wires, which may cause a short circuit of the battery pack.
- Do not transport and store batteries together with metal items such as necklaces and hairpins.
- Do not knock or throw the battery pack.
- Do not directly solder the battery pack or battery, and do not pierce the battery with nails or other sharp objects.
- Please use the charger configured at the time of purchase when charging.

2 Overview

2.1 Summary

DECT (Digital Enhanced Cordless Telecommunications) is a roaming communication system based on DECT technology, which realizes reliable and high-quality wireless IP calls. The DECT system in Single Cell mode does not support roaming and only includes two roles: Manager and terminal.

For users, the DECT system is a cost-effective wireless office system, which provides convenient operation while realizing environmental protection. A framework for cordless communication that provides high-quality voice and data services for high user density, small range communications.

2.2 Specification Introduction

2.2.1 W710D Specification Introduction

Model	Fanwill W710D
Number of Base	20
Number of Handset	10
Concurrent Calls	10
Signal Range	Indoor: 50m Outdoor: 300 m
SIP Account	20
SIP Server	20
Internal Extension	10
Call History	20000
Frequency band	1920~1930 MHz (America) :5 Channels 1880~1900 (European) :10 Channels 1893~1906 MHz (Japan) :5 Channels 1880~1895 MHz (Taiwan) :8 Channels 1910~1920 MHz (Brazil) :5 Channels

	1786~1792 MHz (South Korea) :3 Channels 1910~1930 MHz (Latin America) :10 Channels 1909~1929 MHz (Argentina) :10 Channels
Status indicator light	3
Keys	Reset key x1
IPv6	√
DC Input	5V 1A
Ethernet Port	2 x 10/100M
PoE	√

2.2.2 W610D Specification Introduction

Model	W610D
Screen	240 * 320 color screen
SIP Line	4
Internal Extension	1
Local Contacts	1000
XML Contacts	100
LDAP Contacts	100
Call logs	600
Virtual Dsskey	8x2=16
Talk Duration	8h
Standby Duration	160h

3 Installation

3.1 Packing Contents

3.1.1 W710D Packing Contents

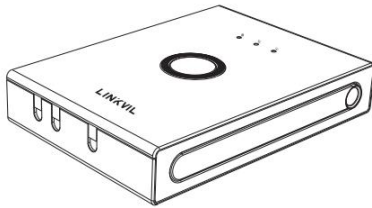

Base Station



PA3 * 8mm screw *

1



PA4 * 30mm screw *

2



Screw fixing seat * 2

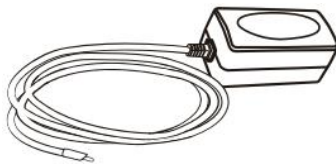

Power Adapter (optional)

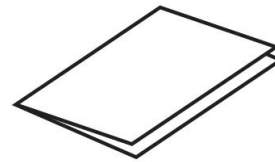

Quick Installation Manual

3.1.2 W610D Packing Contents

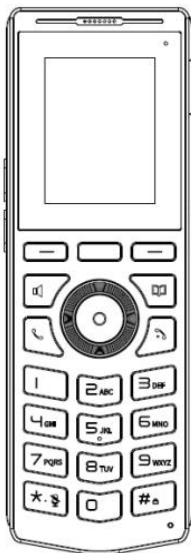

Phone

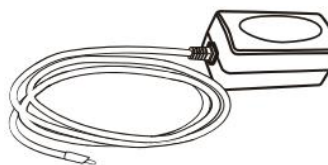

Power Adapter

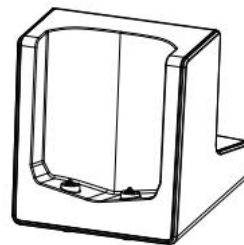

Charging Base

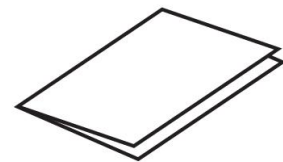

Quick Start Guide

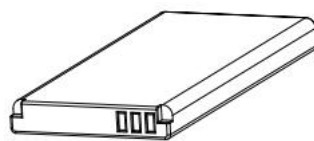

Rechargeable Battery

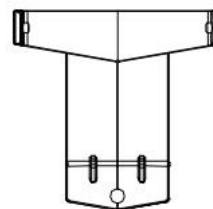

Belt Clip

3.2 Install W710D

Step 1: Prepare before installation

1. Voltage check

Check whether the voltage of DC power supply or external power supply is within the working range of this product (5V/1A).

2. Adjust the antenna (Figure 1)

Press the heads of the antennas at both ends of the device (marked with red lines) with slightly, the antennas will automatically pop out, and then rotate the two antennas clockwise to the desired angle (the maximum rotatable angle is 190°).

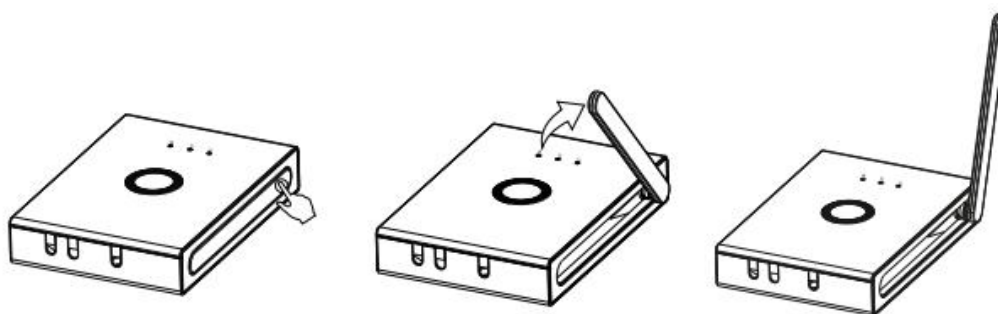

3. Open the back cover (Figure 2)

Follow the arrows to slide down to open the back cover.

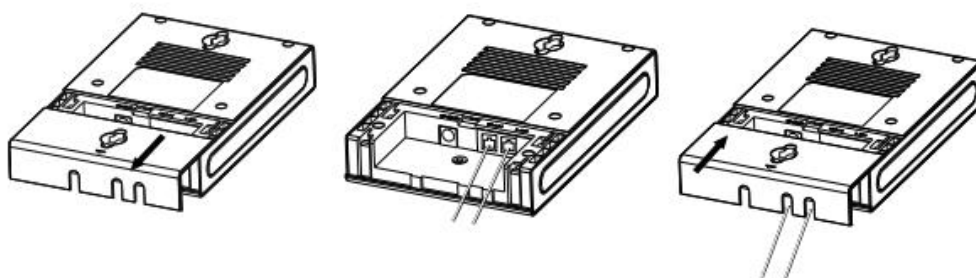

Step 2: Connect your device, please follow the steps below:

1. Insert the ethernet cable into the WAN port of the device and connect the other end of the ethernet cable to an uplink port (a router or a modem, etc.)
2. Insert the power adapter into the device and connect it to a wall outlet.
3. The WAN LED will be solidly lit when the device and network is ready for use.

Step 3: Wall installation

1. Close the back cover of the device after plugging in the cable, and punch the PA3*8mm Screw into the hole in the back cover (Figure 3).

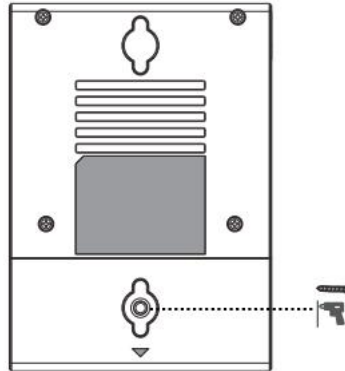

2. Wall mounting can be achieved by hanging the equipment on a screw suitable for the size and distance of the two holes above and below the back shell.

3.3 Install W610D

3.3.1 Installing the battery

4. Removing the rear case: Remove the rear case of the whole machine with a little force from the handset position of the rear case of the main unit.
5. Install the battery: Take out the battery from the packaging box, with the battery with the notch facing up, put the battery C at the battery compartment C, and pull the battery key until it completely fits the underside of the battery.
6. Install the back cover: Align the back cover with the buckle on the back of the main unit, press your hands along the edge of the main unit from top to bottom (there will be a "click" sound during the process), and ensure that there is no gap, it means that the back cover is fastened.

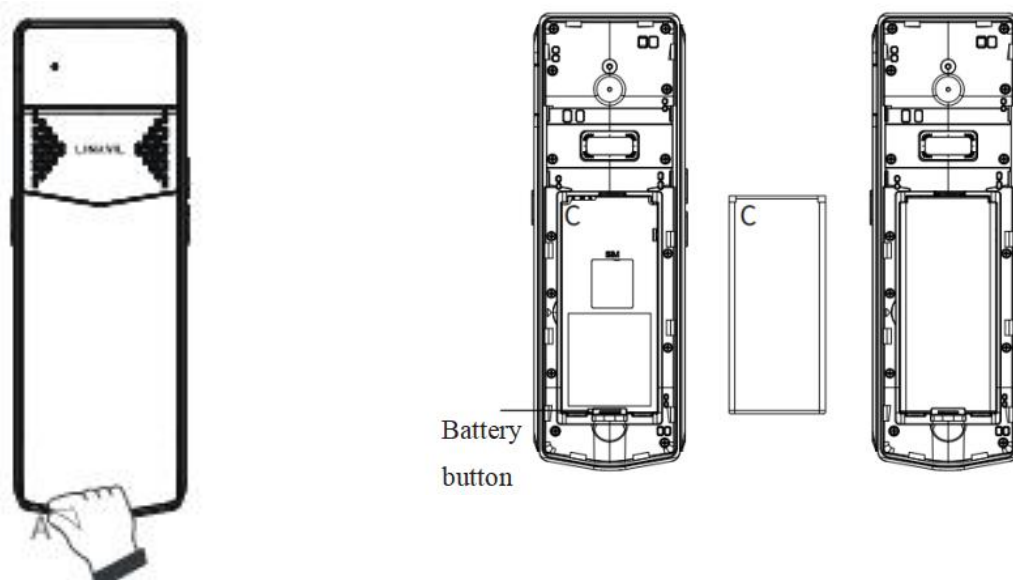

Removing the rear case

Installing the battery

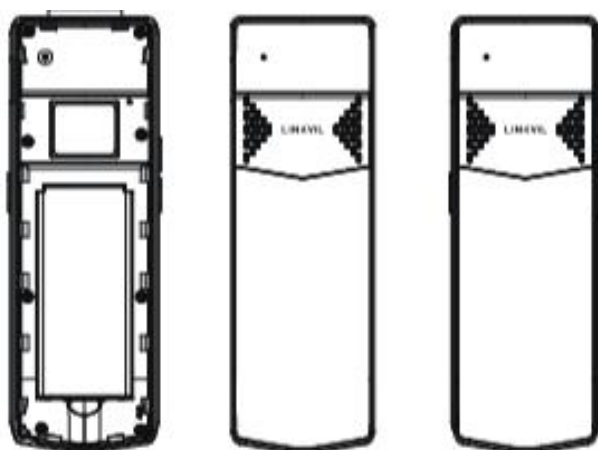

Installing the rear case

3.3.2 Battery Replacement

1. Remove the rear case: Remove the rear case of the whole machine with A. Little force from the handset position of the rear case of the main unit.
2. Remove the battery: Pull the battery key down to remove the old battery.
3. Install the battery: Take out the battery from the packaging box, with the battery with the notch facing up, put the battery C at the battery compartment C, and pull the battery key until it completely fits the underside of the battery.
4. Install the back cover: Align the back cover with the buckle on the back of the main unit, press your hands along the edge of the main unit from top to bottom (there will be a

"click" sound during the process), and ensure that there is no gap, it means that the back cover is fastened.

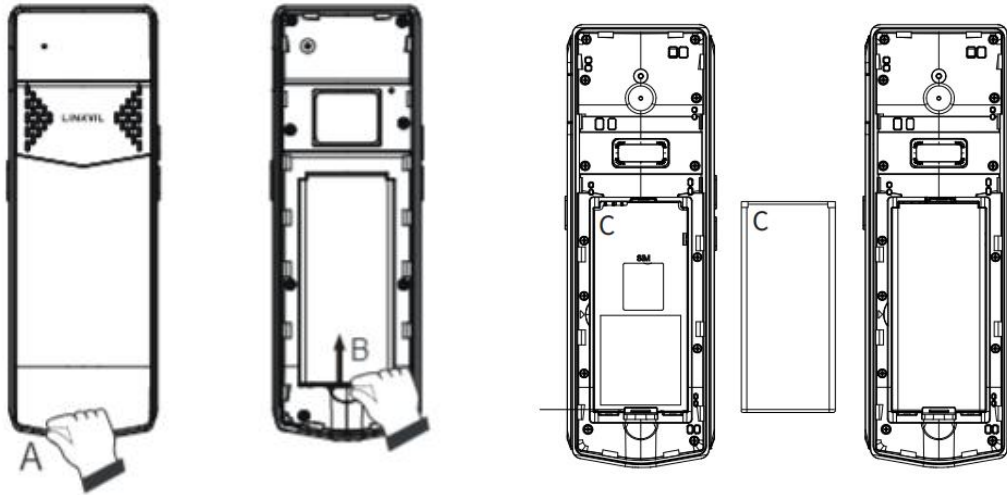

Remove the rear case

Remove the

Install the battery

battery

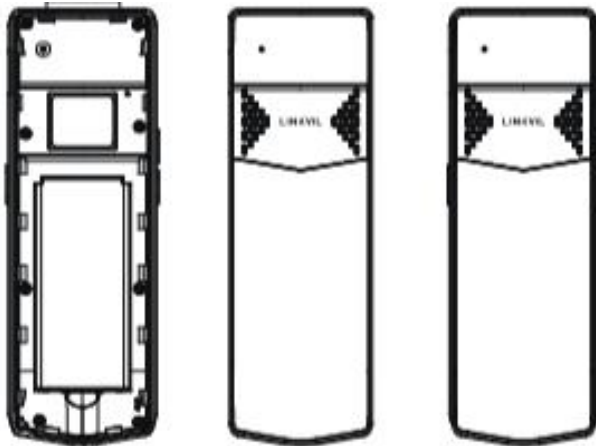

Install the back cover

3.3.3 Connect the charging base

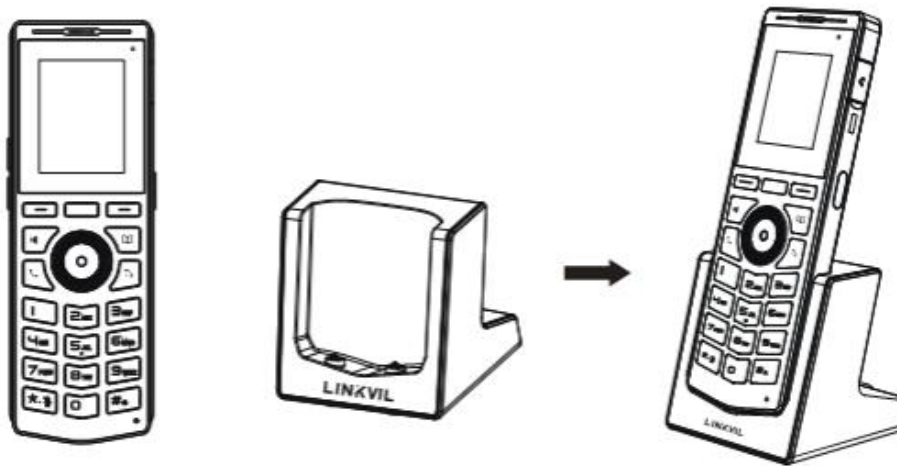

! **Note:**

- Please use the power adapter provided by Fanvil (5V/2A). A third-party power adapter may damage the handset.
- Check the charging status in the top-right corner of the LCD screen.

3.3.4 Installing belt clip

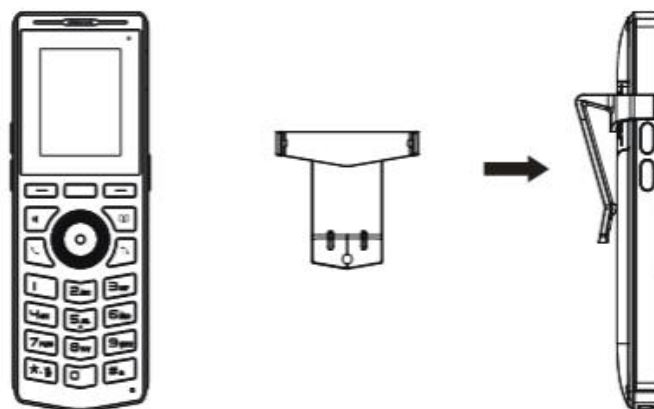

4 Introduction to the User

4.1 Instruction of Keypad

4.1.1 Instruction of Keypad for W710D

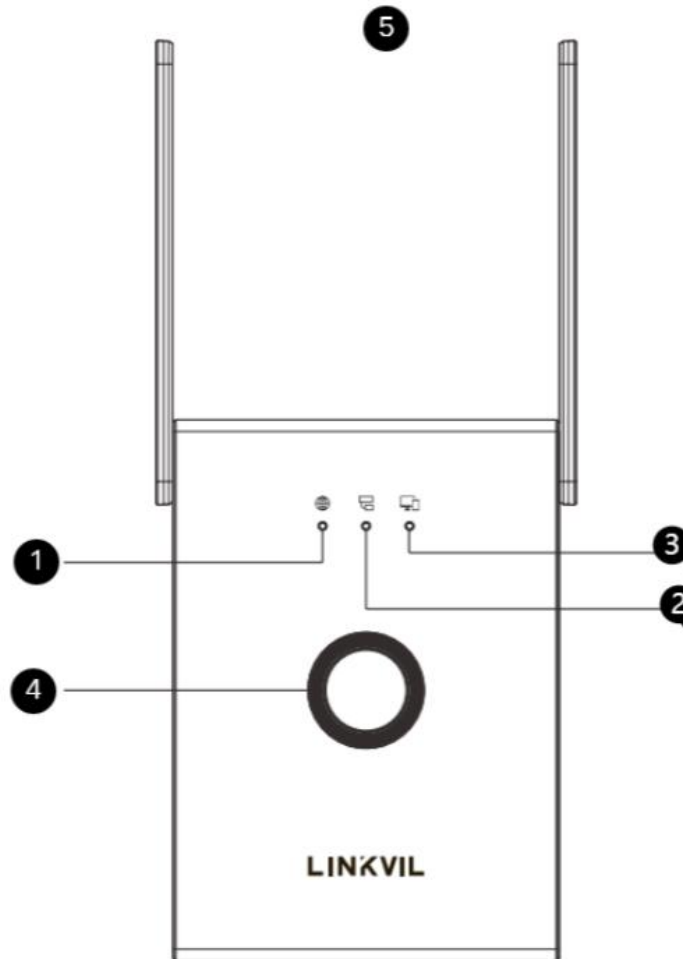

index	name	Description
①	WAN LED	<p>Indicates the WAN connection status.</p> <ul style="list-style-type: none"> ● On: Successfully connected to the local area network ● Off: No network cable inserted ● Flash: Network abnormality, such as IP conflict or inability to obtain IP
②	ROLE LED	Indicates the working role of the device.

		<ul style="list-style-type: none"> ● On: The device works as a Manager
③	DECT LED	Flash: There is a active call in the system
④	Reset key	Long press the reset button to restore the device to its factory settings.

4.1.2 Instruction of Keypad for W610D

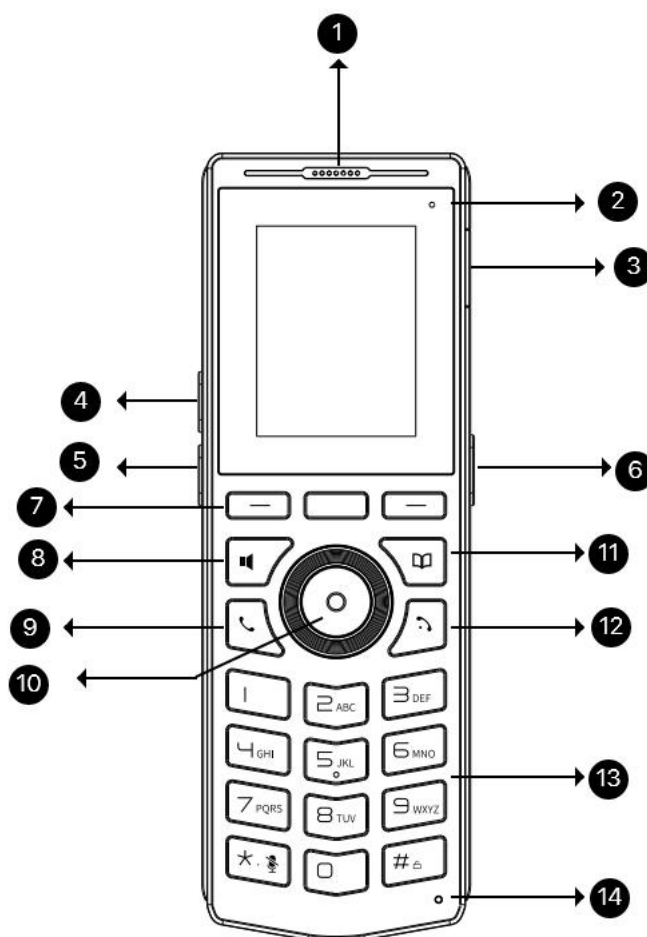

Index	Key Name	Description
①	Earpiece	Play sound when talking in handset mode.
②	Status indicator light	Indicates the status of the device during calls and charging.
③	headset jack	Insert headsets and open the headset channel.
④	Volume Key +	In standby mode, on the ringing and ringing configuration interface, press this key to increase the

		volume of the ringtone; On the call or volume adjustment interface, press this key to increase the volume.
⑤	Volume Key -	In standby mode, on the ringing and ringing configuration interface, press this key to reduce the volume of the ringtone; Press this key to decrease the volume on the call or tone/brightness adjustment interface.
⑥	Side Keys	Before configuration, short/long press to enter the function key setting interface and configure the required functions; After configuration, press to implement the corresponding function.
⑦	Function menu key	These three keys provide corresponding menu functions displayed on the screen
⑧	Handsfree key	Users can press this key to turn on the audio channel of the hands-free speaker.
⑨	Dial key	Dialing; Switch call channels.
⑩	Navigation key/ OK key	Users can press the up/down navigation keys to change the route or move the cursor in the screen list. On some settings and text editing pages, users can press the left/right navigation keys to change options or move the cursor left/right in the screen list. OK key: It is equivalent to the confirmation software key by default, and users can customize the function.
⑪	Phonebook key	By pressing the "Phone Book" key, users can enter the device book interface and select a contact person to make a call.
⑫	On-hook key	Return to the homepage; Hang up the call; Entering sleep mode; Exit sleep mode. Long press to power on/off.
⑬	DTMF Key	These 12 standard keys provide standard device key



		<p>functions. At the same time, long pressing certain keys can trigger the provision of special functions.</p> <p>Press and hold the key # to lock the device (enable keyboard lock configuration).</p> <p>Long press the * key on the standby interface to mute the incoming call ringtone; Long press the * key on the call interface to mute the call.</p>
⑭	Microphone	Receiving audio during calls

4.2 W610D power on/off

Boot up operation

- Long press the red on-hook key  until it boots up.
- Connect the charging base and it will automatically boot up.

Shutdown operation

- Soft shutdown: Long press the red on-hook key  to pop up a shutdown window and select whether to shut down.
- Hard shutdown: Press and hold the red on-hook key  until it shuts down.
- Automatic shutdown when low battery: When the battery is about to run out, it prompts "Low battery". The device automatically shuts down when the battery is depleted.

Reboot

- Go to [Menu]>> [Basic]>> [Reboot System], and select OK to confirm reboot.

4.3 Language settings

Users can set the language of W610D through the device interface, and set the language of W710D through the web interface.

Set language under factory settings for W610D

After startup under factory settings, the device will pop up a language selection box. After

selecting the corresponding language, the user can click [OK] to confirm, or click [Back] to select the default language (default is English).

Set language when standby for W610D

Set the language during standby, go to [Menu]>> [Basic]>> [Language].

W710D web page setting language

Log in to the W710D device webpage and set the language in the dropdown box in the upper right corner of the page

4.4 Country/Region Settings

Different regions have different frequency bands for DECT. In order to ensure the normal use of the DECT system, users need to select the country of W710D and W610D respectively.

Set Country/Region under factory settings for W610D

After the device is started under factory Settings and the language is selected, the device pops up the Country/Region selection box. After the user selects the corresponding Country/Region and clicks "OK", the device automatically reboot. After reboot, the selected country/region is used.

Set Country/Region when standby for W610D

Set the country/region when standby, go to [Menu] >> [Network] >> [Country/Region].

W710D Web page Set Country/Region

Visits the webpage>>Network>>Connection Settings>>Connection Settings, selects the corresponding country or region where the device is located, and sets different operating frequency bands..



Note:

Different countries/regions have different frequency bands, and users must select the

corresponding country/region in order for the device to operate normally.

4.5 W610D Standby Interface

- The left figure shows the default interface when the gamepad is not connected to the Base. The figure on the right below shows the default standby screen interface after connecting Base, which is the status of the user interface most of the time.
- Users can restore the device to the default standby screen interface by pressing the on-hook key.
- The icon description is provided in [16.1 Appendix I](#).



Index	Description
①	The main screen status bar displays the status and information of the device, such as network connection status, battery level, voice mails, missed calls, auto answer, do not disturb, locked status, etc.
②③	Click Softkey-Next to scan the Base and click Cancel to cancel the scan.
④	Display of time and date.
⑤	The registration status of the account
⑥	Function menu keys, which are also the first layer of function menu keys, allow users to operate the device through the keys

1. In some screens, due to too many items or long text, the screen cannot be fully displayed. They will be combined into a list accompanied by scrolling icons. If the

user sees a scrolling icon, they can use the up/down navigation keys to scroll through the list.

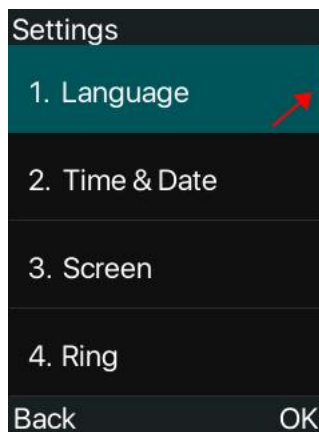

4.6 W610D Menu

In the standby interface, users can access the main menu by pressing the [Menu] softkey; After entering the main menu, select the submenu application icon and click the [OK] key to access the submenu. The main menu displays as follows.



Index	Description
①	The status bar displays the currently selected menu item.
②	Display the application icon for the menu item. The menu item list for W610D is as follows: Status: View the status of Manager, Network, Phone, and Account. Network: Connect to Manager/Base network. Basic: Set personal preference settings.

	<p>Contact: Access all contacts.</p> <p>Message: View voice mails and SMS servers.</p> <p>Call Log: Access the call history list.</p> <p>Features: Set call forwarding, auto answer, call waiting, DND, intercom, ban anonymous calls, and other functions.</p> <p>Application: Set up memos and export logs through a USB drive, Set the Low Battery Tone.</p> <p>Advanced settings: Set keys, upgrade online, and Factory Reset.</p>
③	Softkey key

4.7 Device status

Users can view the status of W610D through the device screen and view the status of W710D through webpage.

View the status of W610D through the screen:

Access [Menu]>> [Status] to obtain the following status information for W610D:

- Manager: displays the IP address, Firmware version, MAC address, RFPI and Country/Region information of manager which the device connected.
- Network: displays the device's network Mode, network IP, RSSI.
- Phone: Display device MAC address, Bluetooth MAC address, IPUI, Model, Hardware version, Software version, Uboot version, memory size, and Uptime information of the device.
- Account: Display the name/number of the device's registered account and registration status information. Account 1-4 is the SIP external line number, and account 5 is the internal extension number.

View the status of W710D through webpage

Refer to [4.7 W710D webpage management](#) login webpage, access the [System] >> [Information] page, and view the device status

- System Information: Display device Model, Hardware, Software, Uptime, Last Uptime, WAN Speed, MEMInfo, System Time, SN information.

- Network: Display device Network Mode, RFPI Code, MAC address, Ethernet IP, Subnet Mask, Default Gateway information.

4.8 Access W710D Webpage

4.8.1 Get IP Address

Users can obtain device IP through scanning tools:

1. The computer is connected to the same local area network as W710D, and Device Manager is installed on the PC

Device Manager:<https://www.fanvil.com/service/doc/soft/tools/tools/ipscanner/index.html>

2. Open the IP scanning tool (Device Manager) and click Rescan to obtain the IP of the W710D device in the local area network.

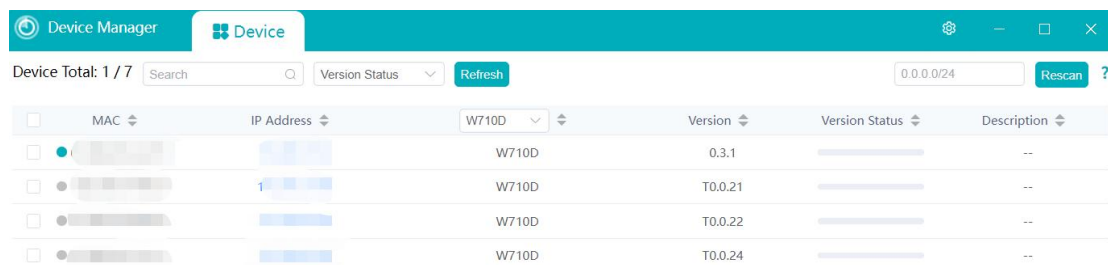

4.8.2 Access Webpage

Ensure that the computer and device are on the same LAN, open the browser, enter the obtained device IP, log in to the device webpage, and enter the login page.

Users must enter their username and password correctly in order to log in to the webpage. The default username and password are both "admin".

4.9 W710D SIP Setting

The terminal device W610D must have a line configured in order to perform call services. W610D can make calls using SIP accounts or internal extension numbers. The use of SIP accounts allows for communication with personnel outside the DECT system; Using an internal extension number can only communicate with terminal devices in the same DECT system.

To use a SIP account, it is necessary to set up information such as the SIP server and SIP account; By using an internal extension, there is no need to configure SIP server or

other information. After the terminal device connects to Manager/Base, it automatically obtains the internal extension number.

The SIP settings for W710D are carried out by the administrator of DECT system, and the steps for setting are as follows:

1. Add SIP server

Visit the W710D Manager webpage>> [SIP Account] >> [SIP Server], click Edit to add a SIP server. Enter the corresponding information for the server address, domain name, and server port, which is provided by the SIP server administrator.

2. Add SIP account

- Manually add a single SIP account: Visit the W710D Manager webpage>> [SIP Account] >>[SIP Account] , click Add, and manually fill in the SIP account information: Authentication User, Authentication Password, User Number, Display Name(SIP Account Name), etc. These information are provided by the SIP server administrator.
- Batch import of SIP accounts: Visit the W710D Manager webpage>>[SIP Account]>>[SIP Account]s, click Export to export the template. After editing the template and adding a SIP account, click Import to import the list of SIP accounts. Note that the imported template must be UTF-8 encoded.

5 Terminal Management

5.1.1 W710D Select Country/Region

The administrator visits the webpage>>Network>>Connection Settings>>Connection Settings, selects the corresponding country or region where the device is located, and sets different operating frequency bands..

 **Note:**

Different countries/regions have different frequency bands, and users must select the corresponding country/region in order for the device to operate normally.

5.1.2 Set PIN code for W710D

Set PIN code

- The administrator visits the Manager webpage>>Network>>Connection Settings>>PIN Code Settings, enters the old password, and confirms the new password.

 **Note:**

The default PIN code is: 1234

5.2 W610D connection network

To use the basic communication functions of the DECT system, it is necessary to first connect the terminal device W610D to Manager/Base W710D. The steps are as follows:

1. System administrator adds authorized devices on W710D

- Manually add a single device: Visit the W710D Manager webpage>>[Handset] >> [Maintenance], click Add, fill in the terminal MAC, Name, select SIP Account and Internal extension number.

Note: Only when authorized access is enabled can the terminal access the

Manager/Base network.

- Batch import of devices: Visit the W710D Manager webpage>> [Handset]>> [Maintenance]>, click Export to export the template. After editing the template and adding devices, click Import to import the device list. Note that the imported template must be UTF-8 encoded.

2. Terminal user connection device

- Under factory settings, after the user starts the W610D device and manually selects the device language and country/region (which must be the same as the Manager), the device will reboot.
- After the device reboot, users can click Softkey-Next or go to enter [Menu]>> [Network]>> [Available Networks], select the Manager's RFPI code, click Link, and enter the PIN code (1234 by default) to successfully connect.
- After a successful connection, the terminal automatically obtains the configuration (assigned SIP account and internal extension number) and can perform calls and other operations.

5.3 Terminal Management

After W610D successfully connects to Manager/Base, the administrator can manage and operate information on the W610D terminal on the W710D Manager>>[Handset] page, including:

- **Terminal information viewing:**
 - Administrators can view the online status, IPUI Code, internal extension number, SIP account, name, model, software version number, and current connection Base of the terminal.
- **SIP account management:**
 - Administrators can perform operations such as adding, deleting, and editing SIP accounts on the terminal. Please refer to [4.8 SIP Settings](#) for specific steps.
- **Operation:**
 - Administrators can perform operations such as Editing/ Deleting/ DND/

Rebooting/ Updating Configurations/ Upgrading on online terminals.

- **Contact management:** Distribute and delete local contacts/ cloud phone book contacts/ LDAP contacts, etc. for the terminal, please refer to [8 Phonebooks](#) for specific methods.
- **View history:** View and manage terminal call records on the Manager webpage. For specific methods, refer to [9 Call History](#).

5.4 W710D Configuration Management

- **Configure terminal configurations on W710D by administrator**
 1. Visit the W710D Manager webpage>> [Handset]>> Configuration, add configuration files, and set configuration file names.
 2. Click the edit button to access the created configuration file, select the desired configuration to make changes.
 3. Visit the W710D Manager webpage>> [Handset]>> [Maintenance], select the device, edit, configure the file, select the file name from the previous step, and click OK.
 4. Visit the W710D Manager webpage>>[Handset]>>[Maintenance], select the device, click Update Config to update the corresponding terminal device configuration.

6 W610D Call Features

6.1 Using Handset / Hands-free Speaker / Headset

- **Using of Handset**

Regarding the use of the handset: Users can press the green dial key to enter the number, then press the dial key or "#" key; Or enter the number first and then press the dialing key, the number will be dialed out. When the speaker is turned on, users can switch device audio channels by pressing the green dial key.

- **Using Hands-free Speaker**

Regarding the use of the hands-free speaker: Users can first press the hands-free key  to dial the number, or dial the number first and then press the hands-free key. When the voice channel of the handset is open, users can switch the device's audio channel by pressing the hands-free speaker key.

- **Using Headset**

Regarding the use of headsets: In the default state, the headset channel is turned on by default after inserting the headsets. When the headsets are inserted, users can enter the number by pressing the dial key, then press the dial key or "#" key; Alternatively, by entering the number first and then pressing the dial key, the number will be dialed out and a call can be established through the headset channel. When the speaker is turned on, users can switch device audio channels by pressing the dial key.

6.2 Initiate a call

6.2.1 Initiate a call

Dialing method

- **Open the dial to make a call:** Use the hands-free key/handset key to open the dial, enter the number, press the Hands-free key/dial key/Softkey-Dial/"#" key to make a call.
- **Pre dial dialing:** Enter the number directly, press the Hands-free key/dial key/Softkey-Dial/"#" key to make a call.

- **Calling through a phone book:** Access [Menu]>> [Contact], or press the devicebook key to access the Local Contacts/Cloud Contacts/LDAP phonebook, select a contact, press Softkey-Option>> Dial /Hands-free key/Dial key, and call out the selected contact number.
- **Calling through call log:** Access [Menu]>> [CallLog], or Softkey - CallLog.
- **Making a second call:** During the call, users can access the [More]>> [New Call]/[Transfer]/[Meeting] keys to make a second call; You can also dial out through the BLF number or Speed Dial function set by the function keys.

Switch line dialing:

- Open the dial using the hands-free/dial keys, or enter the number directly and switch to the line using the navigation key up key.

6.2.2 Call through function keys

Configure function keys on terminal devices

- In standby mode, press Softkey - Dsskey/Navigation key - Left/Navigation key - Right, or the Side Key on the device right to select the function key for editing.

Calling through function keys

3. In standby mode, access the list of dsskeys through Softkey - Dsskey/Navigation key - Left/Navigation key - Right, select function keys, and press the hands-free/dial keys to call out.
4. Press the Side Key on the device right side in standby mode to call out.

6.2.3 Emergency call

The emergency call function is used to enable the keyboard lock, and users can set the corresponding emergency call number on the device. When the device is locked, emergency services can also be called.

The usage steps are as follows:

1. Configure emergency call numbers through the W710D Manager by the administrator: Follow the steps in section [5.4 W710D Configuration Management](#), access the created

configuration file>> [Action]>> [Feature Settings], and set Emergency Call Number. If you need to set multiple Emergency Call Number, please use "," to separate them.

2. After setting the keyboard lock on the device, you can call the emergency call number without unlocking it.

6.2.4 Redial

Users can use the redial button to redial the last dialed number. The steps for redialing are as follows:

1. Set redial button

Users can set the PTT button, function key, or Softkey on the side as the redial key.

Setting method:

- **Set by administrator through W710D Manager**

- According to the steps in [5.4 W710D Configuration Management](#), access the created configuration file>>[Function Key], configure the DSSKEY button, PTT button, and Softkey button as function keys - Redial. Update the configuration to the device.

- **Configure function keys on terminal devices**

Users can set the Side Key, function key, or Softkey on the side as the redial key.

Setting method:

- In standby mode, press the Softkey - dsskey/navigation key - left/navigation key - right, or the Side Key on the device right, select the function key for editing, and set the Keyevent - redial.

2. Redial operation

- Redial the last outgoing number:

When the device opens the dial/standby, press the redial key, and the device will call out the last dialed number.

- Use the redial key to call any number:

Enter the number on the device, press the redial key, and the device will call out the entered number.

6.2.5 Callback

Users can use the callback button to call out the last miss incoming call number (if there is no call record, press the callback button and the device will prompt "Cannot process").

The callback steps are as follows:

1. Set up callback settings
 - **Set by administrator through W710D Manager**
 - According to the steps in section [5.4 W710D Configuration Management](#), access the created configuration file>>[Function Key], and configure the DSSKEY button, PTT button, and Softkey button as the function key - callback. Update the configuration to the device.
 - **Configure function keys on terminal devices**
 - In standby mode, press the Softkey - Dsskey/navigation key - left/navigation key - right, or the Side Key on the device right, select the function key for editing, and set the Keyevent - Callback.
2. When the device opens the dial/standby, press the callback key, and the device will call out the number of the last incoming call.

6.2.6 Anonymous call

The device can set up anonymous calls to hide the calling number and name.

- Anonymous calls are set up by administrators through W710D Manager:
 1. Visit the Manager webpage>>[SIP Account]>>[SIP Account], select a SIP account, click the edit button, and access the Advanced Settings module>>Anonymous Call Standards.
 2. The default value is Disabled, which means it is in the off state. There are two optional parameters, RFC3323 and RFC3325.
 3. Choose any one to enable anonymous calls for this SIP account.

6.2.7 Hotline

After setting up hotline dialing, the device will automatically call according to the hotline delay time by pressing the green dialing key, hands-free key, and other methods to open

the dial.

- Set up hotline dialing by administrator through W710D Manager:
 1. Visit the Manager webpage>>[SIP Account]>>[SIP Account], select a SIP account, click the edit button, and access the Basic Settings module>>Enable Hotline.
 2. Turn on the hotline, set the hotline number, and set the hotline delay time.

6.3 Answer incoming calls

6.3.1 Manual answering

- **Idle state with incoming calls:** Users can answer calls by pressing the Softkey - Answer, dial key , or hands-free key to open the headset/handset/hands-free channel.
- **Answer the second incoming call:** When there is another incoming call during the call, the device will play a call waiting tone in the voice channel of the current call, and the LED indicator light will flash orange quickly. Users can press the Softkey key - Answer; You can also locate the second incoming call through the navigation keys, and answer the call by pressing the Softkey - Answer, dial key, or hands-free keys to open the headset/handset/hands-free channel.

6.3.2 Auto Answer

After enabling the Auto Answer function, the device can automatically answer to incoming calls. Auto Answer can be enabled by distinguishing lines.

It can be set by the administrator on the Manager webpage, or the user can activate the Auto Answer function on the terminal. After enabling auto answer, an icon  is displayed in the upper right corner of the screen.

- **Set by administrator through W710D Manager**
 - Visit the Manager webpage>>[SIP Account]>>[SIP Account], select a SIP account, click the edit button, access the Basic Settings module>>Enable Auto Answer, set the waiting time for Auto Answer, and submit.
- **Configure on terminal devices**
 - Access [Menu]>> [Feature]>> [Auto Answer], press the key to select the line,

use the left/right navigation keys to enable/disable the auto answer, set the auto answer time, and press the [OK] key to save after completion.

6.4 Reject incoming calls

6.4.1 Manual rejection

When receiving a call, you can manually reject it by pressing the Softkey - Reject or on-hook key . Rejected calls will be displayed in the missed call list in the history list.

6.4.2 Ban Anonymous Call

After enabling ban anonymous calls, the device will automatically reject anonymous calls and will not ring. It can be set by the administrator on the Manager webpage or launched by the user on the terminal.

- **Set by administrator through W710D Manager**
 - Visit the Manager webpage>>[SIP Account]>>[SIP Account], select a SIP account, click the edit button, and access the Advanced Settings module>>Turn on [Ban Anonymous Calls] .
- **Configure on terminal devices**
 - Access [Menu]>> [Features]>> [Ban Anonymous Call], press the key to select the line, use the left/right navigation keys to enable/disable the option of ban anonymous calls, and press the [OK] key to save after completion.

6.4.3 DND

Users can enable the DND feature on their device to reject incoming calls (including call waiting). It can be set by the administrator on the Manager webpage or launched by the user on the terminal.

- **Set by administrator through W710D Manager**
 - Access the Manager webpage>>[Handset]>>[Maintenance], select an online device, click the DND button to enable/disable the device's DND.
- **Configure on terminal devices**
 - Access [Menu]>> [Features]>> [DND], enable dnd mode through the left/right

navigation keys, and press the [OK] key to save after completion.

6.5 End Call

After the user's call ends, they can press the Softkey - End key or on-hook key to end the call.

6.6 Dial Query

The device defaults to enabling dial query function. Enter two or more digits of the number, and the dialing interface will automatically match the call history and contact number list. Use the up and down navigation keys to select the number, press the dial key, or call out after timeout.

6.7 Mute

Users can enable mute mode during a call, turn off the device's microphone, and prevent the other party from hearing local sound. Under normal circumstances, the mute mode automatically turns off as the call ends. You can also enable the mute function on the standby page to automatically mute the ringtone when an incoming call occurs.

Mute mode can be activated in all call modes (headset, handset, or hands-free).

6.7.1 Mute the call

Users can mute during calls by long pressing the * key, or mute/unmute using the Softkey key.

- After muting during a call, the call interface displays a mute icon . Muting method during calls:
 1. Press the [More]>> [Mute] key during the call.
 2. Long press the * key during a call.
 1. Unmute call:
 3. Press "More">"Unmute" again on the device to unmute, and the mute icon will no longer be displayed on the call interface.
 4. Or long press * again to unmute the call.

6.7.2 Ringing Mute

Users can mute the ringing sound by long pressing the * key, or enable/disable the mute sound by using the volume up/down key. After mute for incoming calls, the device displays a ringtone mute icon in the upper right corner. When there is an incoming call, the device displays the call interface but does not ring.

- Turn on ringtone muting
 - Press and hold the * key during device standby to mute.
 - Press the volume down key to mute when the device is in standby mode.
- Unmute incoming call ringtone
 - Press and hold the * key during device standby to unmute.
 - Press the volume up key to unmute the ringtone when the device is in standby mode.

After cancellation, the mute icon  will no longer be displayed in the upper right corner.

6.8 Call Hold/Resume

Users can press the Softkey - Hold key to hold the current call, and this key will become a resume key. Users can press the Softkey - Resume key to resume the call.

6.9 Call forwarding

Call forwarding is the function of diverting incoming calls to other numbers. User can configure the call forward settings of each line.

There are three types of call forwarding:

- **Call Forward Unconditional:** Forward all incoming calls to the configured number.
- **Call Forward on Busy:** When the user is busy and call waiting is disabled, incoming calls will be forwarded to the configured number.
- **Call Forward on No Answer:** When user does not answer the incoming call after the configured delay time, the incoming call will be forwarded to the configured number.

Call forwarding can be set by the administrator on the Manager webpage, or by the user on the terminal.

- **Set by administrator through W710D Manager**
 - Visit the Manager webpage>>[SIP Account]>>[SIP Account]>>[Basic settings], set the forwarding type, number, and time.
- **Configure on terminal devices**
 - Access [Menu]>> [Features]>> [Call Forwarding], select the line by the up/down navigation keys, click OK, select the call forwarding type through the up/down navigation keys, click OK, and configure the enable/disable and delay time of call forwarding.

6.10 Call Transfer

When the user is talking with a remote party and wish to transfer the call to another remote party, there are three way to transfer the call, Blind transfer, Attended transfer and Semi-Attended transfer.

- **Blind transfer:** No need to negotiate with the other side, directly transfer the call to the other side.
- **Semi-Attended transfer:** When you hear the ring back, transfer the call to the other party.
- **Attended transfer:** When the caller answers the call, transfer the call to the other party.

6.10.1 Blind Transfer

During the call, the user presses the function menu key [More]>> [Transfer], enters the number to be transferred, or presses the contact key or history key to select the number. Press the transfer key again to blindly switch to a third party. After the third party rings, the device displays "Transferring"; After the third-party answers, the device shows successful transfer and hangs up.

6.10.2 Semi-Attended Transfer

During the call, the user presses the [Transfer] key on the function menu, enters the

number to be transferred, or presses the contact key or history key to select the number. When the call key is pressed, and the third party is not answering, the user presses the transfer key on the call interface to perform Semi-Attended transfer or press the end key to cancel Semi-Attended transfer.

6.10.3 Attended Transfer

Attending transfer is also known as the "courtesy mode", which involves calling the other party and waiting for them to answer the call before transferring the call.

Calling is also the same process. In dual call mode, press the [Transfer] key to transfer the first call to the second call.

6.11 Call Waiting

After enabling the call waiting function, users can accept new incoming calls during the call process; After turning off the call waiting function, new incoming calls will be automatically rejected and a busy tone will be displayed.

When the call waiting prompt is enabled, the device will play a beep tone when a new call is received during the call.

Call waiting can be set by the administrator on the Manager webpage, or by the user on the terminal.

- **Set by administrator through W710D Manager**
 - According to the steps in [5.4 W710D Configuration Management](#), access the created configuration file>>[Actions]>>[Feature Settings], enable/disable [Enable Call Waiting], and click submit to save. Update the configuration to the device.
- **Configure on terminal devices**
 - Access [Menu]>> [Features]>> [Call Waiting]>> [Call Waiting Settings], use the left/right navigation keys to enable/disable call waiting and call waiting tone.

6.12 Conference

The device supports creating local and network conference. The conference mode is set by the administrator through the W710D Manager. The setting method is as follows:

- Access the Manager webpage>> [SIP Account]>> [SIP Account]>> [Basic Settings]>and set the conference mode.

6.12.1 Local Conference

Users need to set the conference mode to local for local conference.W610D support 6 ways local conference.

Two methods for creating local conference

- The device already has two calls. Press the [More]>> [Conference] key on the call interface, select the conference number through the navigation up and down keys, and press the [OK] key to establish a local conference.
- There is a one way call on the device. Press the conference key on the call interface, enter the number you want to join the conference, and press the dial key; After receiving the call from the other end, press the conference key again to establish a local conference.

6.12.2 Network Conference

The user needs support from the SIP server for network conference. Please confirm with the administrator.

How to join a network conference

- Multiple party call network conference room number, enter password to enter all conference rooms.
- Two devices have established a regular call. Press the conference key to invite new members to the conference, and follow the voice prompts to proceed.



Note:

- Network conferencing requires server support. Please confirm with the administrator whether the account supports network conference.
- The methods and steps for participating in network conferences on different servers may vary. Please confirm the specific steps with your administrator.

- The maximum number of attendees for server conference varies depending on the server.

7 W610D Advanced Call Feature

7.1 Call Park

Users can suspend a call during a call and then retrieve the call on this or other devices.

 **Note:**

- The call park function requires support from the server. Please confirm with the administrator.
- The call park or retrieve methods of different servers may vary. Please confirm with your administrator.

Set function keys

To use the call dwell function, it is necessary to set the function key to the Call Park button in advance. The function key can be set through the terminal device or configured through the W710D webpage management function key.

- **Configure function keys by administrator in W710D Manager**

According to the steps in section [5.4 W710D Configuration Management](#), access the created configuration file>>[Function Keys], configure the DSSKEY or Side Keys, with the key type being Memory Key - Call Park, set the key values and save them, assign the configuration to the corresponding device and update it.

- **Configure function keys on terminal devices**

In standby mode, press the Softkey - Dsskey/navigation key - left/navigation key - right, or the Side Key on the device right, select the function key for editing, set the function key type to Memory Key - Call Park to set the key value and save it.

Call park/ retrieve through function keys

- During a call, press the Call Park function key to pause the call.
- When idle, you can press the corresponding function key on this device or other devices to retrieve calls.

7.2 Intercom

After enabling the intercom function, the device can auto answer incoming calls in intercom mode.

7.2.1 Make Intercom Call

7.2.1.1 Regular intercom

To use the intercom function, it is necessary to set the function key to the Memory - Intercom key in advance.

The function key can be set through the terminal device or configured through the W710D webpage management function key.

- **Configure function keys by administrator in W710D Manager**
 - According to the steps in section [5.4 W710D Configuration Management](#), access the created configuration file>>[Function Keys], configure the DSSKEY or Side Keys, with the key type being Memory Key - Intercom, set the key values and save them, assign the configuration to the corresponding device and update it.
- **Set intercom function keys**
 - In standby mode, press Softkey - Dsskey/navigation key - left/navigation key - right, or the Side Key on the device right, select the function key for editing, set the function key type to Memory Key - Intercom, set the key value and save it.
- **Make intercom calls through function keys**
 - Press the intercom function key to make a intercom call.

7.2.1.2 PTT Intercom

Set PTT intercom function key

To use the PTT intercom function, it is necessary to set the function key to PTT - intercom key in advance. The function key can be set through the terminal device or configured through the W710D webpage management function key.

- **Configure function keys by administrator in W710D Manager**
 - According to the steps in section [5.4 W710D Configuration Management](#),

access the created configuration file>>[Function Keys], configure the PTT button with the PTT intercom type, set the key value and save it, assign the configuration to the corresponding device and update it.

- **Set PTT intercom function key**
 - In standby mode, press the Side Key on the device right to edit, set the function key type to PTT intercom, set the key values and save them.

- **PTT intercom call through function keys**
 - In standby mode, press and hold the Side Key to initiate a intercom call.
 - Release the key to end the call.

7.2.2 Answer Intercom Call

After enabling the intercom mode, the device can auto answer incoming calls in intercom mode.

5. Enable intercom on terminal devices

Access [Menu]>> [Features]>> [Intercom] to enable/disable intercom.

The explanation of the intercom configuration Parameters is as follows:

Item	Description
Intercom	When the Intercom is enabled, the device will auto answer the incoming call with the SIP header Call-Info command.
Intercom Mute	Enable mute function during intercom mode calls.
Intercom Tone	The device plays an announcement when receiving an incoming call in intercom mode.
Intercom Barge	Enable the Intercom Barge, when the device is in calls and receives a new intercom call, it auto answers the call.

7.3 Message

7.3.1 SMS

If the service of the SIP account supports the SMS function, when the other party sends a SMS to this number, the user will receive a notification of the SMS and display a new

SMS icon  on the standby screen interface.

- **Send SMS**

1. Visit [Menu]>> [Message]>> [SMS], create a new message, select the route and the number to send it to
2. After editing, click send to proceed

- **View SMS**

1. Access [Menu]>> [Message]>> [SMS], select [Inbox], and enter the SMS inbox interface
2. Select the unread message and press the [OK] key to read it

- **Reply to SMS**

1. Access [Menu]>> [Message]>> [SMS], select [Inbox], and enter the SMS inbox interface
2. Select the message you want to reply to, select [Option]>> [Reply], edit it, and click send to proceed

7.3.2 Voice Mail

If the server of this line supports voice mail function, the calling party can keep the voice mail to the server when the user does not respond. The user will receive a notification of the server's voice mail and a new voice mail icon will be displayed on the standby screen interface.

To listen to voice mails, users must first configure a voice mailbox number. After configuring the voice mailbox number, users can retrieve voice mails for the default SIP line.

Steps for listening to voice mails:

- Select [Menu]>> [Message]>> [Voice Mail]
- Select [OK] to open the voice mail configuration interface, and select the desired route by pressing the up/down navigation keys.
- Press the [Edit] key to edit the number for the voice mail. Once completed, press the

[OK] key to save the configuration.

- SIP1 (m/n) Line: "m" before parentheses represents unread voice mails, and "n" represents the total number of voice mails.
- Call the voice mail number, enter the PIN code according to the prompt tone, and listen to the voice mail.

8 Phonebook

8.1 Local phonebook

Users can save contact information in their phone book and directly dial the contact's phone number in the device book. Users can open their phone book by pressing [Menu]>[Contact] or the preset key on the device [Contact].

By default, the device book is empty, and users can manually add or add contacts to the device book from their call history (or cloud phone book).

The contacts will be sorted alphabetically. Users can browse by pressing the up/down navigation keys. The current record indicator tells the user the specific location of the currently located contact. Users can view contact information by pressing the [OK] key.

8.1.1 Add/edit/delete contacts

To add a contact, the user needs to enter the contact group and press the "Add" button to open the interface for adding a contact.

- Name
- Office number
- Mobile
- Other
- Line
- Ring type
- Group

Users can edit contacts by pressing the [Option]>> [Edit] key.

To delete a contact, the user should first move the indicator to the contact they want to delete, press the [Option]>> [Delete] key, and confirm by pressing [OK].

8.1.2 Add/Edit/Delete Groups

By default, the group list is empty. Users can create their own groups, edit group names, add or remove contacts from groups, and delete groups.

- Add Group: Access [Menu] >> [Contact] >> [Local Contacts], and press the [Add] key.
- Delete the group: Select the group, press the [Option]>> [Delete] key, and press [OK] to confirm.
- Edit the group: Press the [Option]>> [Edit] key.

The total number of contacts in this group is indicated in parentheses.

8.1.3 View/Add/Delete Contacts

Open the group list, and users can view the contacts in the group by pressing the [OK] key.

When viewing contacts in a group, users can enter the add contact interface by pressing the [Option]>> [Add] key, and then click [OK] to save the contact. This contact will also be synchronized and saved to the [local contacts]>> [All Contacts]. You can also delete contacts in the group through [Option]>> [Delete].

8.2 Cloud Contacts

Cloud phone book allows users to download phone books from cloud servers to their devices. This is very convenient for office users to use the device book. The phone book can be downloaded from the cloud phone book server with just one click, making it very convenient for creating and maintaining contact lists.

Note:

Cloud phone was originally designed to ensure that its content is the latest version, and each time it is opened, it only temporarily downloads its contacts to the device. However, downloading may take a few seconds depending on the network connection quality during device use. Therefore, in order to save waiting time for downloading, it is recommended that users save important contact information from the cloud phone book to the local location.

8.2.1 Configure Cloud Contacts

Configure cloud phone book by administrator in W710D Manager

Visit the Manager webpage>>[Phonebook]>>[Cloud Phonebook], configure the name, URL, username, and password of the cloud phone book. After configuration is completed, when the handset connects to the Manager/Base network, the contact person of the cloud phone book can be obtained.

8.2.2 Download cloud phone book

To access the list of cloud phone books, access [Menu]>>[Phonebook]>>[Cloud Phone Book] through W610D, where the XML directory is the directory of the cloud phone book.

8.3 LDAP Contacts

8.3.1 Configure an LDAP phone book

Configure LDAP phone book by administrator in W710D Manager

Visit the Manager webpage>>[Phonebook]>>[Cloud Phonebook]>>[LDAP], configure the name, address, query Base, username, and password of the LDAP phone book. After configuration is completed, when the handset connects to the Manager/Base network, the contact person of the LDAP phone book can be obtained.

8.3.2 Download the LDAP phone book

After the administrator has configured the LDAP phone book, the user can access the list of cloud phone books through W610D and access [Menu]>> [Contacts]>> [Cloud Contacts], where the LDAP directory is the directory of the LDAP phone book.

8.4 Blocked List

The device supports block lists. If a number is added to the Blocked List, the incoming call from that number will be directly rejected by the other end, and the local device will display missed calls. (Prevent the number in the call list from being called out normally)

- There are multiple ways to add a device to the Blocked List, which can be directly added in [Menu]>> [Contacts]>> [Blocked List].

- Select any number in the device book (both local and network) to add.
- Select any number in the call history to add.

8.5 Allowed List

The device supports the allowed list, such as adding a number to the allowed list. Even when DND/forwarding is enabled, the device can still receive calls from that number (numbers outside the allowed list will be automatically rejected/forwarded, etc.).

- You can directly add allowed list in [Menu]>> [Contacts]>> [Allowed List], set the number/prefix, and the type of allowed call.
- Select any number in the device book (both local and network) for configuration and addition.
- Select any number in the call history to configure and add.

9 Call history

Viewing call logs on the device

- **View call logs:** The phone can store call logs (the number of stored calls varies depending on the specifications). Users can click [Menu]>> [Call Log]>> [Local Call Log] to open call logs and view all incoming, outgoing, and missed call logs.
In the call history screen interface, users can browse call logs by pressing the up/down navigation keys.
- **Delete call logs:** Users can delete call logs by pressing the [Option]>> [Delete] key, or [Option]>> [Delete All] to delete all call logs.
- **Add to Phone Book:** Each call record will display "Call Type", "Caller Number/Name", and "Call Time". Users can further check the details of call logs by pressing the [OK] key and dial by pressing the [Option]>> [Dial] key, or add numbers from call logs to the device book by pressing [Option]>> [Add to Contacts].

Administrators view call logs through Manager

- Visit the Manager webpage>>[Call Logs]>>[Call Logs], view and search for call records of all devices, and export and clear call records.
- Visit the Manager webpage>>[Call Logs]>>[Call Record Statistics] to view the number of calls in the system, as well as the number of incoming calls, outgoing calls, missed calls, and forwarded calls.

**Note:**

Deleting and clearing call records in the Manager will not affect the display of call records on the device.

10 Advanced Features

10.1 Time Plan

Time Plan settings can be used to set a time point or a time period. A time point is when an action is executed at a certain moment, and a time period is when an action is executed at a certain time.

Administrators can manage the time plan of W710D or manage the time plan of terminals through W710D Manager.

10.1.1 W710D Time Plan

- The time plan types supported by W710D include: Timed Reboot, Timed Upgrade, and Timed Config.
- The Repetition Period can be set to: No Repetition, Daily, Weekly, Monthly.
- The method of setting is:
 - Visit the Manager webpage>>[Actions]>>[Time Plan], set the Name, Type, and Repetition Period, as well as the Effective Date and Time, then click add. After the setup is completed, W710D will execute the corresponding action at the set time.

Configuration parameter description:

Item	Description
Name	The name of the custom time plan rule.
Type	Action types executed at time points/time periods: Timed Reboot, Timed Upgrade, Timed Config.
Date	When the repetition type is Daily/No Repetition, the value is empty.
Effective Time - Start Time	The start time when the rule takes effect.
Effective Time - End Time	The end time of the rule.

**Note:**

If there are calls during the set time period, it will skip the reboot/upgrade operation.

10.1.2 W610D Time Plan

- The time plan types supported by W610D include: Timed Reboot, Timed Upgrade, Timed Forwarded, and Timed Config.
- The repetition type can be set to: No Repetition, Daily, Weekly, Monthly.

Setting method:

- **Configure time plan by administrator in W710D Manager**

According to the steps in [5.4 W710D Configuration Management](#), access the created configuration file>>[Actions]>>[Time Plan], configure the name, action type, and repetition type, as well as the effective date and time, and click Add. After setting up, assign the configuration to the corresponding device and update it, and the corresponding terminal will execute the corresponding action at the set time.

10.2 Action Plan

Action Plan is a technology defined and designed by Fanvil for remote control and behavior linkage between Fanvil terminal devices and other devices. That is, when an event occurs on the Fanvil terminal, the terminal can execute an action that is completed according to a Plan rule.

Setting method:

- **Configure Action Plan for the terminal by the administrator through the Manager webpage**

According to the steps in [5.4 W710D Configuration Management](#), access the created configuration file>>[Line]>>[Action Plan] and configure the action plan rules. After setting up, assign the configuration to the corresponding device and update it, and the corresponding terminal will execute the corresponding action when the event occurs.

Configuration parameter description:

Item	Description
Action	<p>The action is when the rule for number configuration is triggered.</p> <p>The supported types are:</p> <p>Record: When the rule is triggered, the phone automatically activates the recording function.</p> <p>Mute: The phone automatically mutes when the rule is triggered.</p> <p>Answer: When the rule is triggered, the phone automatically answers incoming calls.</p>
Number	<p>The call number corresponding to each Action Plan; Supports the same number expression as DialPlan</p>
Type	<p>The types of time periods triggered by rule execution, including:</p> <p>Early: Trigger execution before call establishment.</p> <p>Connected: Trigger execution after call establishment.</p>
Line	<p>The selected rule corresponds to the matching SIP line.</p>
Direction	<p>Behavior processing method for corresponding configuration rules:</p> <p>Both: trigger both incoming and outgoing calls simultaneously;</p> <p>Deactivation: Triggered upon outbound call:</p> <p>Incoming call: triggered when an internal call is received.</p>

10.3 Maintenance

10.3.1 W710D Configuration File

Users with administrator privileges can view, export, or import phone configurations on the W710D webpage>>[System]>>[Configurations] page, and can also restore the phone to its factory settings.

Import/Export Configurations

- Visit the W710D webpage>>[System]>>[Configurations]>>[Export Configurations], select the corresponding format, click download to export the configuration file in the corresponding format;

- Visit the W710D webpage>>[System]>>[Configurations]>>[Import Configurations], select the configuration file, click upload to import the configuration file.

Clear The Tables

- Visit the W710D webpage>>[System]>>[Configurations]>>[Clear The Tables], select the database list, move to the clear list, and click clear to clear the selected data.

Factory Reset

- Visit the W710D webpage>>[System]>>[Configurations]>>[Reset Devices], and clear all device data, including configuration and database tables.

10.3.2 Upgrade

There are three upgrade methods for W710D:

- 1) Web upgrade
- 2) Online upgrade
- 3) Automatic deployment upgrade.

There are four ways to upgrade the W610D:

- 1) Manually upgrade the handset through the W710D web page;
- 2) Upgrade the handset online through W710D;
- 3) USB upgrade;
- 4) Upgrade via USB flash drive



Note:

- During the process of uploading the version and upgrading the software, do not disconnect the power supply or network.
- The W610D will only be upgraded if it meets both charging and non-talking conditions.
- The W610D web and online upgrade process takes approximately 5 hours;The USB upgrade and USB flash drive upgrade take about 3 minutes.It can be selected according to different scenarios and requirements.

- W610D Web upgrades and online upgrades use “xxx.z” software, USB upgrades and USB flash drive upgrades use “xxx.bin” files.

10.3.2.1 Web page upgrade

W710D webpage upgrade

- Visit the W710D webpage>>[System]>>[Upgrade]>>[Software Upgrade], select the W710D software version, click Upload, and upgrade the W710D software.

Upgrade the W610D through the W710D web page

- Visit W710D webpage >> [Handset] >> [Maintenance], select the terminal to be upgraded, click the Upgrade button, select the W610D software version, and upgrade the W610D software.

10.3.2.2 Online upgrade

Through online upgrades, it is possible to upgrade W710D and also upgrade W610D terminals managed by W710D.

Configuration for online upgrade by administrator on W710D Manager webpage:

- Visit the W710D webpage>>[System]>>[Upgrade]>>[Online Upgrade] to configure the upgraded server and update cycle. Place the upgraded TXT file and software on the corresponding server. When the device detects that the software stored on the server does not match its own software version number, it will prompt for an upgrade.

Configuration parameter description:

Item	Description
Upgrade server	
Enable Auto Upgrade	Enable Auto Upgrade, If there is a new version txt and new software firmware on the server, phone will show a prompt upgrade message after Update Interval.
Upgrade Server Address1	Set available upgrade server address.
Upgrade Server Address2	Set back up available upgrade server address.

Update Interval	Set Update Interval. Enable Auto Upgrade and configure the Update Interval. If the server has a new firmware, the phone will prompt for upgrade at the interval.
Firmware Information	
Current Software Version	It will show Current Software Version.
Server Firmware Version	It will show Server Firmware Version.
[Upgrade] button	If there is a new version txt and new software firmware on the server, the page will display version information and upgrade button will become available; Click [Upgrade] button to upgrade the new firmware. Note you can only upgrade the firmware for W710D using the button.
New Firmware Information	When there is a corresponding TXT file and version on the server side, the TXT and version information will be displayed under the new version description information.

Step instructions:

1. After completing the configuration of the Manager webpage, place the version information TXT file in the configured HTTP server. Note that Manager/Base and handle use different version TXT files.

The naming format of the version information TXT file is vendor_model_hwv1,0.txt. The corresponding version information file names for W710D and W610D are as follows:

Model	Version information file name
W710D	fanvil_W710D_hwv1_0.txt
W610D	fanvil_W610D_hwv1_0.txt

2. The TXT file format must be UTF-8, and the content format is:

```
Version=2.12.0 # Software version number
Firmware=http://ip:port/xxx.z #The URL of the software version file
BuildTime=2023.09.11 20:00
Info=TXT
```

Release Note:

Xxxxx

Xxxxx

Xxxxx

3. After the update interval is reached, if the server has available TXT files and version files, W610D automatically detects the upgrade in the charging and non-call state; The W710D webpage displays the upgrade button available and the Release Note in the TXT file, which users can click to upgrade to the W710D version.

W610D upgrade and upgrade pause

1. When W710D detects that the version number in the TXT file is different from the current version number of the handset, it pushes a new software version to the handset.

The new firmware is automatically upgraded when the handset is in the following states:

- The handset is in charging state
- The handset is not talking state

When the handset is in the upgrade state, the upgrade icon  is displayed on the standby status bar/screen saver screen. You can also view the upgrade status and progress from the handset Menu > Advanced > Upgrade.

2. When the handle is in the following state, the upgrade processing event is paused. After the event is over, the upgrade continues.

- Pause the upgrade when there is an incoming/outgoing call, or during call. The upgrade will continue after end of call.
- When power is off/shut down/restarted, the upgrade is suspended; The upgrade will continue after the restart.
- When the network is disconnected (for example, outside the Base signal range), the upgrade is suspended; The upgrade will continue after the network is normal.

When the handset is in the paused upgrade state, the upgrade pause icon is displayed on the standby status bar or screen saver screen. You can also view the paused upgrade

status and upgrade progress from the handset Menu > Advanced > Upgrade.

10.3.3 Auto Provision

Administrators can auto provision W710D devices.

3. Visit the W710D webpage>>[System]>>[Auto Provision] and configure the Auto Provision parameters.
4. The terminal supports four methods to obtain Auto Provision application parameters: SIP plug and play, DHCP parameter selection, static deployment of servers, and TR069. If these four methods are configured simultaneously, the device will be upgraded based on the method obtained first.
5. Transport protocol support: FTP, TFTP, HTTP, HTTPS.
6. This article only briefly introduces Auto Provision. For detailed instructions, please refer to the document Fanvil Auto Provision.

Configuration parameter description

Items	Description
Basic settings	
Authentication Name	The user name of provision server
Authentication Password	The password of provision server
Configuration File Encryption Key	If the device configuration file is encrypted , user should add the encryption key here
General Configuration File Encryption Key	If the common configuration file is encrypted, user should add the encryption key here
Download Fail Check Times	If there download is failed, phone will retry with the configured times.
Update Contact Interval	Phone will update the phonebook with the configured interval time. If it is 0, the feature is disabled.
Download Common Config enabled	Whether phone will download the common configuration file.
Enable Server Digest	When the feature is enable, if the configuration of server is

	changed, phone will download and update.
DHCP Option	
Option Value	Configure DHCP option, DHCP option supports DHCP custom option DHCP option 66 DHCP option 43, 3 methods to get the provision URL. The default is Option 66.
Custom Option Value	Custom Option value is allowed from 128 to 254. The option value must be same as server define.
Enable DHCP Option 120	Use Option120 to get the SIP server address from DHCP server.
SIP Plug and Play (PnP)	
Enable SIP PnP	Whether enable PnP or not. If PnP is enable, phone will send a SIP SUBSCRIBE message with broadcast method. Any server can support the feature will respond and send a Notify with URL to phone. Phone could get the configuration file with the URL.
Server Address	Broadcast address. As default, it is 224.0.0.0
Server Port	PnP port
Transport Protocol	PnP protocol, TCP or UDP.
Update Interval	PnP message interval.
Static Provisioning Server	
Server Address	Provisioning server address. Support both IP address and domain address.
Configuration File Name	The configuration file name. If it is empty, phone will request the common file and device file which is named as its MAC address. The file name could be a common name, \$mac.cfg, \$input.cfg. The file format supports CFG/TXT/XML.
Protocol Type	Transferring protocol type , supports FTP、TFTP、HTTP and HTTPS
Update Interval	Configuration file update interval time. As default it is 1, means phone will check the update every 1 hour.
Update Mode	Provision Mode. 1. Disabled.

	<p>2. Update after reboot.</p> <p>3. Update after interval.</p>
TR069	
Enable TR069	Enable TR069 after selection
ACS Server Type	Select TR069 Serve type.
ACS Server URL	ACS server address
ACS User	ACS server username (up to is 59 character)
ACS Password	ACS server password (up to is 59 character)
TLS Version	TLS version (TLS 1.0, TLS 1.1, TLS 1.2)
INFORM Sending Period	INFORM signal interval time. It ranges from 1s to 999999s
STUN Server Address	Configure STUN server address
STUN Enable	To enable STUN server for TR069

11 W610D preference settings

11.1 Time Setting

Setting method:

When the device is in standby mode, access the device function menu key [Menu]>> [Basic] key>> [Time&Date] key, use the up/down navigation keys to edit/time Parameters, and then press [OK] to save.

Configuration Parameter description:

Parameter	Description
Mode	Choose the synchronization server time or manually set it
SNTP Server	SNTP service address
Time Zone	Select Time Zone
Format	Choose a time format from the following formats: <ul style="list-style-type: none"> ● DD MMM WW ● MMM DD WW ● WW DD MMM ● WW MMM DD ● DD MM YY ● DD MM YYYY ● MM DD YY ● MM DD YYYY ● YY MM DD ● YYYY MM DD
Separator	Select the separator between year, month, and day
12 Hours Clock	Display 12 hour clock
Daylight Saving Time	Daylight Saving Time Settings, Disable/Auto/Manual (Web Settings)

11.2 Screen Setting

Users can edit screen Parameters by accessing the function menu keys [Menu]>> [Basic]>> [Screen]. After editing, click [OK] to save.

11.2.1 Backlight

- Set the Backlight Active Level from 1 to 16 when in use, and switch the brightness level between [<] or [>].
- Set the Backlight Inactive Level from 0 to 16 in energy-saving mode, and switch the brightness level between [<] or [>].
- Set the Backlight Time, the value is 1 minute by default, which can be turned off or selected as 15 S/ 30 S/ 1 min/ 2 min/ 5 min/ 10 min/ 30 min/ 1 h/ 2h/ 3h/ 6h/ 15h or customized.

11.2.2 Screensaver

Access [Menu]>> [Basic]>> [Screen], edit the [Screensaver] Parameters, press the [Left]/[Right] keys to enable/disable the screen saver, set the timeout time, default to 15 seconds, and press the [OK] key to save after completion

11.2.3 Sleep

Entering sleep mode

- When there is no operation on W610D, it defaults to entering sleep mode for 30 seconds.
- Press the red on-hook key  in standby mode to enter sleep mode.

Exit sleep mode

- The device will automatically exit sleep mode upon receiving notifications such as incoming calls.
- Press any key on the device to exit sleep mode.

Sleep Mode Settings

- Access the device [Menu]>> [Basic]>> [Screen], edit the [Time Out To Sleep] item,

which defaults to 30 seconds. You can disable it or set it to 15 S/30 S/1 min/2 min/5 min/10 min/20 min/30 min.

11.3 Audio Setting

11.3.1 Ringing Tone

Set ring type

- Access the device>> [Menu]>> [Basic]>> [Ring], edit the parameters for [Ringtone Type], use the left and right navigation keys to edit the ring type, and press [OK] to save after completion.

Set ring volume

- Access the device>> [Menu]>> [Basic]>> [Ring], edit the [Headset] and [Handfree] Parameters, use the left and right navigation keys to edit the ringtone volume, and press [OK] to save after completion.

Set vibrate mode

- Access the device>> [Menu]>> [Basic]>> [Ring], edit the [Vibrate Mode] parameters, use the left and right navigation keys to select enable/disable vibration mode, and press [OK] to save after completion.

11.3.2 Voice Volume Setting

Set voice volume

- Access the device>> [Menu]>> [Basic]>> [Voice Volume], edit the parameters of [Handset Volume], [Handsfree Volume], and [Headset Volume], use the left and right navigation keys to edit the audio volume, and press [OK] to save after completion.

11.4 Greeting Words settings

Set greeting words

- Access the device>> [Menu]>> [Basic]>> [Greeting Words], edit the greeting words and press [OK] to save.

12 Function Keys

Function keys can be set through terminal devices or configured through W710D web page management function keys.

- **Configure function keys by administrator in W710D Manager**

According to the steps in section [5.4 W710D Configuration Management](#), access the created configuration file>>[Function Keys], configure the DSSKEY or PTT buttons, which can be BLF/Speed Dial/PTT buttons/Intercom, etc. Assign the configuration to the corresponding device and update it.

- **Configure function keys on terminal devices**

In standby mode, press Softkey - Function key/Navigation key - Left key/Navigation key - Right key, or the PTT button on the right to select the function key for editing.

Function key usage

Dsskeys support the following types:

- Memory Key
 - Speed Dial: In standby or off hook mode, press this button to directly dial the number set by the speed settings.
 - Intercom: Call out the set number through intercom, and when the other party is set to receive intercom calls, they can automatically answer the intercom calls.
 - Voice Mail: Used to configure Voice Mail numbers and lines. When the indicator light is on, it indicates that there is new voice information.
 - Call Forwarding: After the configuration, you can press this key to enable Call Forward Unconditional to a specified number when the device is idle. When the device receives an incoming call, press this key to forward the call to a specified number.
 - Call Park: Used to switch to other devices or locations during a call.
 - BLF (New Call/BXFER/XFER/CONF/DTMF): Used to indicate the status of the subscribed extension (idle, ringing, or calling out); Answer the incoming call from the extension when it is called; If a pick up number is configured, incoming calls can be pick up when the extension rings. The subtypes of BLF are as follows:
 - ◇ BLF/NEW CALL: During a call, pressing this button can initiate a new call

to the subscribed extension without hanging up the current call.

✧ BLF/BXFER: During a call, press this button to blindly redirect the call to the subscribed extension.

✧ BLF/AXFER: During a call, press this button to transfer the call attendance to the subscribed extension.

✧ BLF/CONF: During a call, press this button to invite the subscribed extension to attend the conference.

✧ BLF/DTMF: During a call, press this button to send DTMF.

➤ Presence: Similar to the BLF function key, it is used to indicate the status of subscribed extension numbers. Note that different servers do not support different subscription types.

● Function keys

➤ Voice Mail: Display detailed information of voice speakers for all SIP lines.

➤ DND: Enter the DND settings interface and enable/disable the DND function.

➤ Call hold: Keep/resume the current call.

➤ Call transfer: Enter the transfer interface, with the same function as the Softkey transfer button.

➤ Phonebook: Enter the phone book interface.

➤ Redial: Redial the last dialed number.

➤ Pickup: When other devices ring, press this button to enter the dialing interface. Enter the ringing extension number to pick up the call.

➤ Join: Join all established calls along the way.

➤ Call forward: Enter the call forwarding settings interface.

➤ Call Logs: Enter the call history viewing interface.

➤ Flash: Pressing this button during a call will keep the current call, and another line will start dialing. You can hear the dialing tone.

➤ Memo: Enter the memo interface.

➤ Headset: Answer incoming calls or switch to the headset channel during calls through headset mode.

➤ Release: Press this button to return to the standby interface when there is no call; Pressing this key during a call can end all calls and return to the standby interface.

- Lock Phone: When the keyboard lock function is enabled, press this button to manually lock the keyboard.
- SMS: Enter the SMS interface.
- Call Back: Callback the number of the last incoming call.
- Hide DTMF: Enter the hide DTMF settings interface.
- Intercom: Open the dial and call out the entered number through intercom.
- Group Listen: Press this button during a call to play the other person's voice through the earpiece/earphone and hands-free.
- Prefix: Configuration number prefix. When dialing, press this button to automatically add a prefix number.
- End: Ends the current call.
- Disposition: This feature relies on Broadsoft servers and is a method of recording call information in the call center.
- Escalate: This feature is related to Broadsoft servers, and during a call, press to send the corresponding SIP message to the server.
- Trace: This feature is related to Broadsoft servers and sends call information during or after a call.
- Handsfree: Enter the hands-free dialing number or switch the hands-free channel.
- Answer: Press the button to answer an incoming call.
- Local contact: Enter the local contact interface.
- XML Group: Enter the cloud phone book interface.
- Auto Headset: enable or disable the Auto Headset mode, which is enabled by default.
- Dsskey Page 1: Enter the Dsskey display/settings interface on the first page.
- Dsskey Page 2: Enter the Dsskey display/settings interface on the second page.
- DTMF: Press this button during a call to send the configured values in sequence to the remote end.
- URL: Access the configured remote URL address, which can be set to an XML phone book address, etc.
- BLF List key: This function depends on the Broadsoft server. Add the numbers that

need to be subscribed to in the server to the group, use the URL address of the group to subscribe to all the numbers in the group, and display the corresponding number, name, and status on the indicator light of the BLF List key. The BLF List is automatically issued by the server based on configuration, without the need for users to manually configure values and names.

- XML Browser: Place the configured XML file on the HTTP/HTTPS server, press this button to retrieve the XML content and perform corresponding actions based on the content.

13 W710D Network Settings

13.1 Ethernet Settings

IPv4 Settings

- There are two modes to choose from for IPv4 network types: DHCP and Static IP.
- When the network type is set to DHCP, the phone is issued a network IP address by the DHCP server (router).
 - DNS Server Configured by DHCP: enabled by default, for domain name resolution.
 - Time Synchronized Via DHCP: disabled by default. It controls whether using the DHCP server time.
- When the network is set to Static IP, the IP address needs to be manually set.
 - IP address: Fill in the IP address you want to set.
 - Subnet Mask: Set subnet mask.
 - Default Gateway: used to achieve network interconnection and can be filled in according to one's own needs.
 - Primary DNS server: The IP address of the primary DNS server
 - Secondary DNS server: The IP address of the backup DNS server.

IPv6 Settings

- There are two types of IPv6 network modes available: DHCP and Static IP.
- When the network type is set to DHCP, the phone is issued a network IP address by the DHCP server (router).
 - DNS Server Configured by DHCPv6: enabled by default, for domain name resolution.
 - Time Synchronized Via DHCPv6: disabled by default. It controls whether using the DHCP server time.
- When the network is set to Static IP, the IP address needs to be manually set.
 - IP address: Fill in the IPv6 address you want to set.
 - Prefix Length: The number of IPv6 prefix bits, where the prefix represents the network bit, similar to the subnet mask of IPv4.

- Default Gateway: used to achieve network interconnection and can be filled in according to one's own needs.
- Primary DNS server: The IP address of the primary DNS server
- Secondary DNS server: The IP address of the backup DNS server.

13.2 Network Mode

Network Mode

- There are three modes to choose from for the phone IP Mode: IPv4, IPv6, and IPv4&IPv6. Users can set the network mode of W710D in the Manager webpage>>[Network]>>[Network Mode].

13.3 Web Server Type Settings

Setting method

- Visit the Manager webpage>>[Server Port]>>[Server Port Settings] to configure the web server type. You can configure parameters such as web login protocol type and login port.

Configuration Description

- Web Server Type: Reboot to take effect after settings. Optionally, the web page login is HTTP/HTTPS.
- Web Logon Timeout: Default as 15 minutes, the timeout will automatically exit the login page, need to login again.
- Web auto login: After the timeout does not need to enter a user name password, will automatically login to the web page.
- HTTP Port: The default is 80. If you want system security, you can set ports other than 80. Such as :8080, webpage login: HTTP://ip:8080
- HTTPS Port: The default is 443, the same as the HTTP port.

13.4 VPN

Function Description

- Virtual Private Network (VPN) is a technology to allow device to create a tunneling connection to a server and becomes part of the server's network. The network transmission of the device may be routed through the VPN server.
- For some users, especially enterprise users, a VPN connection might be required to be established before activate a line registration. The device supports two VPN modes, Layer 2 Transportation Protocol (L2TP) and OpenVPN.
- The VPN connection must be configured and started (or stopped) from the device web portal.

L2TP Setting Method

- To establish a L2TP connection, users should log in to the device web portal, open webpage [Network] >> [VPN]. In VPN Mode, check the "Enable VPN" option and select "L2TP", then fill in the L2TP server address, Authentication Username, and Authentication Password in the L2TP section. Press "Apply" then the device will try to connect to the L2TP server.
- When the VPN connection established, the VPN IP Address should be displayed in the VPN status. There may be the delay of the connection establishment. User may need to refresh the page to update the status.
- Once the VPN is configured, the device will try to connect with the VPN automatically when the device boots up every time until user disable it. Sometimes, if the VPN connection does not establish immediately, user may try to reboot the device and check if VPN connection established after reboot.

Note:

The device only supports non-encrypted basic authentication and non-encrypted data tunneling. For users who need data encryption, please use OpenVPN instead.

OpenVPN setup method

- To establish an OpenVPN connection, user should get the following authentication and configuration files from the OpenVPN hosting provider and name them as the

following,

- OpenVPN Configuration file: client.ovpn
 - CA Root Certification:ca.crt
 - Client Certification:client.crt
 - Client Key:client.key
- User then upload these files to the device in the web page [Network] >> [VPN], select OpenVPN Files.
 - Then user should check “Enable VPN” and select “OpenVPN” in VPN Mode and click “Apply” to enable OpenVPN connection.
 - Same as L2TP connection, the connection will be established every time when system rebooted until user disable it manually.

13.5 VLAN

VLAN (Virtual Local Area Network) technology can divide a LAN into multiple logical LANs - VLANs, each VLAN is a broadcast domain, and broadcast packets are limited within one VLAN.

W710D supports obtaining VLAN IDs through LLDP, CDP, DHCP, and manual settings.

LLDP (Link Layer Discovery Protocol)

- Visit W710D webpage>>[Network]>>[Advanced]>>Link layer discovery protocol, configure LLDP parameters:
 - Enable LLDP: Enable LLDP protocol functionality.
 - Packet Interval: LLDP message sent periodic interval.
 - Enable Learning Function: Enable LLDP self-learning VLAN configuration function

CDP (Cisco Discovery Protocol)

- Visit W710D webpage>>[Network]>>[Advanced]>>Cisco Discovery Protocol, configure CDP parameters:
 - Enable CDP: Enable CDP protocol functionality.
 - Packet Interval: CDP message sent periodic interval.

DHCP VLAN

- Visit W710D webpage>>[Network]>>[Advanced]>>DHCP VLAN settings, configure DHCP VLAN parameters:
 - Option Value: Enable or disable obtaining VLAN ID through DHCP Option.
 - DHCP Option VLAN: Set the Option value, 128-254, and obtain the VLAN value through DHCP

Set VALN Manually

- WAN VLAN Settings: Visit the W710D webpage>>[Network]>>[Advanced]>>[WAN VLAN Settings], manually set the WAN port VALN ID:
 - Enable VLAN: Enable manual setting of WAN port VLAN function
 - WAN VLAN ID: Set WAN language ID.
- LAN VLAN Settings: Visit the W710D webpage>>[Network]>>[Advanced]>>[WAN VLAN Settings], manually set the LAN port VALN ID:
 - LAN VLAN mode: Enable or disable the setting of LAN port VLAN. When enabled, the LAN port VLAN mode can be set to Follow WAN, which is the same as the WAN port VLAN ID; Or manually set the LAN port VLAN.
 - LAN VLAN ID: Set LAN ID.

14 W610D Connecting Peripherals

14.1 USB flash drive

W610D can export log files and perform upgrades through USB. Please refer to [16 Troubleshooting](#) for the method of upgrading and exporting logs through USB.

 **Note:**

- The W610D device does not provide power to the USB device, so a USB hub is needed to connect the USB drive and W610D phone.
- The USB Hub interface needs to be Type-C.

14.2 Wired Headset

The device supports wired Headset with a 3.5mm headset interface, enabling the Headset to play incoming call prompts, earphone calls, and more.

After the device is connected to the headsets, the status bar displays the headset icon, indicating that the headset channel is available.

14.3 PTT Headset

The W610D is compatible with PTT headset HT601, and the PTT headset function can be used after the PTT headset is inserted into the headset port of the handset.

The PTT headset has the following two buttons:

- PTT headset side key: equivalent to the PTT key on the side of the handset. After the configuration is complete, hold down the key to initiate a call and release the key to end the call.
- PTT headset speed dial key: The middle key of the PTT headset. After the configuration is complete, press the key to initiate a call, and press the key again to end the call.

14.3.1 PTT Headset Side key

Configure the PTT headset side key

- Configure the PTT headset side key via Manager: According to the steps in section [5.4 W710D Configuration Management](#), access the created configuration file>>[Function Keys]>>[PTT]>>[PTT 1], set the function key Type (PTT key by default), Name, Line, and Value, and click Apply to Save.
- Configure the PTT headset side key Using W610D, there are two methods:
 - 1) If the function key is not configured, press the side key of the PTT headset to enter the configuration interface, set the Type (PTT key by default), Name, Line, and Value, and click OK to Save.
 - 2) Access W610D menu >> Settings >> Keyboard >>DSS Key Settings, enter the configuration interface, configure theType (PTT key by default), Name, Line, and Value, and click OK to Save.

Use the PTT headset side key

- If the PTT type is configured, hold down the PTT headset side key to initiate a call, and release the key to end the call.

14.3.2 PTT Headset Speed Dial key

Configure the PTT headset speed dial key

- Configure the PTT headset side key via Manager: According to the steps in section [5.4 W710D Configuration Management](#), access the created configuration file>>[Function Keys]>>[PTT]>>[PTT 2], set the function key Type (Speed key key by default), Name, Line, and Value, and click Apply to Save.
- Configure the PTT headset side key Using W610D, there are two methods:
 - 1) If the function key is not configured, press the middle key of the PTT headset to enter the configuration interface, set the Type (speed dial by default), Name, Line, and Value, and click OK to Save.
 - 2) Access W610D menu >> Settings >> Keyboard >>PTT Headset key, enter the configuration interface, configure theType (speed dial by default), Name, Line, and Value, and click OK to Save.

Use the PTT headset speed dial button

If the key is configured as the speed dial type (the default is speed dial type) :

- In the standby state, press the key to initiate a call.
- When an incoming call is coming, press the key to answer the call.
- In the power off/call state, press the key to end the call.

14.4 Bluetooth Headset

The W610D device is equipped with BT5.0 built-in.

Setting method

- The device is in default standby mode. Go to [Menu]>>[Basic]>>[Bluetooth], select Bluetooth, and use the navigation keys - left/right to turn it on. If no pairing is displayed, press the [Scan] button to enter the Bluetooth search interface for scanning, select the scanned Bluetooth device to connect.

15 Security

15.1 W610D Menu Password

The menu password is used to access the [Menu]>>[Advanced] directory, and users can customize the menu password. Access the device [Menu]>>[Advanced], enter the current menu password (default password is 123), access [Security]>>[Menu Password], and set the parameters:

- Current Password: The password set for you, with a default password of 123.
- New Password: is the new menu password you want to reset.
- Confirm Password: Enter a new menu password that must be exactly the same as the new password.

After setting, the password will take effect immediately, and a new password is required to enter the device menu.

15.2 W710D webpage password

Users can customize and modify their webpage login password by accessing the W710D webpage [System]>>[User Configuration]>>[User Account] and selecting the account to modify it.

- Old Password: Enter the webpage login password
- New Password: Enter the login password that needs to be modified
- Confirm Password: Enter the login password that needs to be modified again

After changing the password, it will automatically log out and you need to enter a new password to log in again.

15.3 W610D keyboard Password

The keyboard Password is used to unlock the keyboard after the phone keyboard is

locked.

Set Keyboard Lock

- Access the device [Menu]>>[Advanced], enter the current menu password (default password is 123), access [Security]>>[Keyboard Password], select the Keyboard Status, and set the Keyboard Timeout time.
 - Keyboard Status: Menu Keys/DSS keys/All keys. The keyboard lock will lock for the aforementioned keyboard range after timeout.
 - Keyboard Timeout: Lock the keyboard after the timeout period.

Set keyboard Password

- Access the device [Menu]>>[Advanced], enter the current menu password (default password is 123), access [Security]>>[Keyboard Password]>>[Set Password], and modify the keyboard Password.
- Current Password: The current password.
- New Password: is the new menu password you want to reset.
- Confirm Password: Enter a new menu password that must be exactly the same as the new password.

Unlock

- After the keyboard is locked, the device status bar will display a keyboard lock icon. At this time, pressing any key will prompt for a password. After entering the keyboard Password, the keyboard can be unlocked.
- When the Keyboard Status is disabled, long press the "#" key to lock and then long press the "#" key again to unlock.
- When the Keyboard Status is enabled the Keyboard Timeout is 0, long press the "#" key to lock and enter the keyboard password to unlock.

15.4 W710D Web Filter

Users can set that only machines with a certain IP segment are allowed to access

configuration management devices

Access the W710D webpage [Security]>>[Web Filter], adding and removing IP segments are accessible. Configure the starting IP address within the start IP, end the IP address within the end IP, and click [Add] to submit to take effect. A large network segment can be set, or it can be divided into several network segments to add. If the user wants to delete, select the initial IP of the network segment to be deleted from the drop-down menu, and then click [Delete] to take effect.

Enable Web Filter: configure enable/disable Web Filter; Click the [Apply] button to take effect.

Enable web page filtering: configure to enable/disable web page access filtering; Click the [Submit] button to take effect



Note:

If the device you are accessing is in the same network segment as the phone, please do not configure the filter segment of the web page to be outside your own network segment, otherwise you will not be able to log in the web page.

15.5 W710D Mutual Authentication

W710D supports mutual authentication both of HTTPS and SIP TLS.

Certificate Management

- Device Certificate: Visit the W710D webpage [Security]>>[Device Certificate] and set the device certificate parameters:
 - Device Certificate: Select the device certificate sent by the device for authentication, and you can choose the default built-in certificate of the device; You can also choose to customize the certificate and use the certificate uploaded by the user.

- Import Certificate: Upload a custom device certificate.
- Certificate List: displays a list of uploaded custom device certificates, only one custom device certificate can be uploaded. When no custom certificate is uploaded, the certificate list appears empty
- Trust Certificate: Visit the W710D webpage [Security]>>[Trust Certificates], set the trust certificate parameters:
 - Permission Certificate: used to confirm whether server certificate authentication is enabled.
 - Common Name Validation: Whether to enable regular name verification.
 - Certificate Mode: Select the certificate module to use, with the following parameter descriptions:
 - ✧ All Certificates: Choose to trust all certificate modules, including custom uploaded trust certificate lists and device built-in trust lists.
 - ✧ Default Certificates: Select the trust certificate list built into the trusted device.
 - ✧ Custom Certificates: Select the trust custom uploaded trust certificate list.
 - Import Certificates: Used to import trust certificates on the server side.
 - Certificates List: displays a list of server trust certificates uploaded by the user.

Mutual Authentication Description

- Upload the device certificate used by W710D to the server's trust certificate list, and confirm that there is a device certificate for the device in the server's trust certificate list. Please confirm with the server administrator.
- Visit the W710D webpage [Security]>>[Trust Certificates]>>[Import Certificates], upload the device certificate from the server to the trust certificate list of the W710D device, and select the trust certificate module to use.

15.6 W710D Firewall

Set up a network firewall

- Accessing the W710D webpage>>[Security]>>[Firewall], you can set whether to enable the input through this page, output firewall and set the firewall input and

output rules. Using these Settings can prevent some malicious network access, or restrict internal users access to some resources of the external network, which can improve security.

Function Description

- Firewall rule set is a simple firewall module. This feature supports two types of rules: input rules and output rules. Each rule is assigned an ordinal number, allowing up to 10 for each rule.
- After setting the parameters, click [Add] and a new item will be added in the firewall output rule.
- Select the list you want to delete, click [Delete] to delete the selected list.

Parameter Description:

Parameter	Description
Enable Input Rules	Indicates that the input rule application is enabled.
Enable Output Rules	Indicates that the output rule application is enabled.
Input/Output	To select whether the currently added rule is an input or output rule.
Deny/Permit	To select whether the current rule configuration is disabled or allowed;
Protocol	There are four types of filtering protocols: TCP UDP ICMP IP.
Src Port Range	Filter port range
Src Address	Source address can be host address, network address, or all addresses 0.0.0.0; It can also be a network address similar to *.*.*.0, such as: 192.168.1.0.
Dst Address	The destination address can be either the specific IP address or the full address 0.0.0.0; It can also be a network address similar to *.*.*.0, such as: 192.168.1.0.
Src Mask	Is the source address mask. When configured as 255.255.255.255, it means that the host is specific. When set as 255.255.255.0, it means that a network segment is filtered.
Dst Mask	Is the destination address mask. When configured as

	<p>255.255.255.255, it means the specific host. When set as 255.255.255.0, it means that a network segment is filtered.</p>
--	---

16 Troubleshooting

16.1 Obtain System Information

16.1.1 Obtain Information for W710D

Obtain System Information through W710D

Visit the W710D webpage>>[System]>>[Information] page to obtain information. The following information will be provided:

- System Information: Display device Model, Hardware, Software, Uptime, Last Uptime, WAN Speed, MEMInfo, System Time, SN information.
- Network: Display device Network Mode, MAC address, Ethernet IP, Subnet Mask, Default Gateway information.

Obtain System Information through W610D

When W610D is connected to Manager/Base and the connection status is normal, the IP address, firmware version number, MAC address, and currently selected country/region of the Manager in the system can be obtained by accessing W610D device>>[Menu]>>>[Status]>>[Manager].

16.1.2 Obtain system information for W610D

Obtain Information through W710D

After W610D successfully connects to Manager/Base, the administrator can view the information of the W610D terminal on the W710D Manager webpage>>[Handset], including the terminal's online status, MAC address, internal extension number, SIP account, name, model, software version number, and current connection to Base.

Obtain Information through W610D

Access the device's [Menu]>>>[Status] to obtain the following status information for W610D:

- Manager: displays the IP address, firmware version, MAC address, and area

information of manager which the device connected.

- Network: displays the device's network mode, network IP, connected network name, BSSID, and signal strength information.
- Phone: Display device MAC address, Bluetooth MAC address, model, hardware version, software version, Uboot version, memory size, and uptime information of the device.
- Account: Display the name/number of the device's registered account and registration status information. Account 1-4 is the SIP external line number, and account 5 is the internal extension number.

16.2 W610D power on/off

Please refer to [4.2 W610D power on/off](#) operation.

16.3 Reboot

Reboot W710D

- Visit the W710D webpage>>[System]>>[Reboot], click the Reboot button to reboot .
- Simply unplug the power and reboot the device.

Reboot W610D

- Visit the W710D Manager webpage>>[Handset]>>[Maintenance], select the online terminal, and click the Reboot button. Multiple terminals can be selected at once for reboot .
- Visit W610D>>[Menu]>>[Basic Settings]>>[Reboot System], select OK to reboot .

16.4 Reset Device to Factory Default

Resetting Device to Factory Default will erase all the user's configuration, preference, database and profiles on the device and restore the device back to the state as factory default.

Reset W710D

- Visit the W710D webpage>>[System]>>[Configuration]>>[Reset Devices], click the

Reset button to reset.

- Long press the Reset button on the W710D device to reset.

Reset W610D

- Visit W610D>>[Menu]>>[Advanced], then enter the password to enter the interface, select [Factory Reset], click OK to reset.
- Long press the OK button on the standby interface of W610D to reset.

16.5 Screenshot

If there is a problem with the terminal device, screenshots can help technicians locate the functional location and clarify the problem phenomenon.

Take screenshots of connected terminals through W710D Manager

Visit the W710D Manager webpage>>[Handset]>>[Diagnosis], select the online device, click the screenshot button, and save the pictures (you can capture them in the interface with problems). Save the image and send it to the technical personnel to locate the issue.

16.6 Network Packets Capture

Network packets capture can help technicians analyze and locate problems.

Capture packets of W610D through Manager

Visit the W710D Manager webpage>>[Handset]>>[Diagnosis], select the online device, click the start packet capture button, and perform the operation of reproducing the problem. After the problem occurs, click the end packet capture button to save the data packet. Users can analyze data packets or send them to technical support email.

Capture packets for W710D

Visit the W710D Manager web page>>[System Tools]>>[LAN Packet Capture], click the [Start] button, and a message will pop up asking the user to save the captured file. At this

point, users can perform related operations, such as starting/stopping the line or making a phone call. After completion, click the [Stop] button on the webpage. All network packets during the device period are saved in files. Users can analyze data packets or send them to technical support email

16.7 Get Log Information

Log information can help technicians analyze and locate problems.

Obtain log for W610D through Manager

Visit the W710D Manager webpage>>[Handset]>>[Diagnosis], select the online device, click the Settings button, enable logging, and set the logging level to Debug. Perform the operation of reproducing the problem. After reproducing the problem, click on Export Log and save the log file. Users can analyze log information or send it to technical support email.

N **ote:**

When the system log level of the terminal is Debug, it will have a certain impact on the performance of the terminal, such as shortened standby time, delayed response, etc. After the problem is resolved, please set the log level to the default Error.

Obtain log information for W710D itself

Visit the W710D Manager webpage>>[System Tools]>>[Device Logs], click the [Start] button, follow the steps of the problem until it appears, then click the [Stop] button, and [Save] to analyze locally or send the logs to technical personnel to locate the problem.



16.8 W610D USB/USB drive upgrade

When there are some abnormal problems with the device, you can try to upgrade and recover the software through USB under the guidance of technical support personnel.

Please obtain the steps and tools for upgrading USB/USB drives from technical support

personnel.









16.9 Common Trouble Cases

Fault cases	Solution
Device could not boot up	<ol style="list-style-type: none"> 1. First consider the situation that the battery has been exhausted, and charge the device. Please use the charger configured at the time of purchase when charging. 2. If you see the phone enter "POST mode", it means that the phone system is damaged. Please contact technical support to help you restore the phone system.
The device is frozen on a screen and cannot be operated	<ol style="list-style-type: none"> 1. Hold down the red hang-up button to force power off, and hold down the red hang up button again to power on. After the power on, you can export logs and send them to the technical support.
Device could not register to a service provider	<ol style="list-style-type: none"> 1. Please check whether the phone is connected to the network. The phone needs to be connected to a wireless network, and check whether the wireless icon is normal. If the icon shows  or , the network is unavailable, please check the network facilities. 2. Please check whether the phone has an IP address. Check the system information. If the IP address is Negotiating..., it means that the phone has not obtained an IP address. Please check whether the network configuration is correct. 3. If the network connection is good, please check your line configuration again. If all configurations are correct, please contact your service provider for support, or follow the instructions in "16.6 Network Packet Capture" to obtain a registered network packet and send it to the manufacturer's support mailbox to help analyze the problem.
No Audio or Poor Audio in Handset	<ol style="list-style-type: none"> 1. Please check whether the headset is connected, the headset icon  is displayed in the upper right corner. After

	<p>connecting the headset, the earpiece channel cannot be used; after unplugging the headset, the earpiece channel can be used.</p> <p>2. At this point the network bandwidth and latency may not be suitable for audio calls.</p>
<p>Poor Audio or Low Volume in Headset</p>	<p>1. Please use the Headset provided by manufacturer.</p> <p>2. The network bandwidth and delay may be not suitable for audio call at the moment.</p>
<p>Audio is chopping at far-end in Hands-free speaker mode</p>	<p>This is usually due to loud volume feedback from speaker to microphone. Please lower down the speaker volume a little bit, the phenomenon will be gone.</p>



















17 Appendix

17.1 Appendix I - W610D Key Icons

Icon	Description
	Programmable keys, the default is PTT Key, which can be set to function key/speed dial key, etc.
	Volume keys, in standby or ringing state: increase or decrease ringer volume During a call: increase or decrease the volume of the headset, handset, hands-free
	Softkey
	Up, down, left, right navigation keys, and OK key By default, the functions of each button during standby: Up key: Call history Down key: status Left key: Enter the DSSKEY Page1 settings page Right key: Enter the DSSKEY Page2 settings page OK key: Long press to Factory Reset.
	Return to the homepage; Hang up the call; Enter sleep mode; Exit sleep mode Long press to power on/off
	Dial; switch the call channel
	Phone book keyboard
	Hands-free key, turn on/off the hands-free channel

17.2 Appendix II - W610D Status and Notification Icons





Display icons	Icon Explanation
---------------	------------------





	In hands-free mode
	In headset mode
	In handset mode
	Mute activated
	Silent mode
	Call is on hold
	Auto-answering activated
	Call forward activated
	Do not disturb activated (Red)
	Bluetooth device paired connection
	Keypad locked
	Forward call(s)
	Missed call(s)
	Received call(s)
	Dialed call(s)
	Network connected
	Network disconnected
	Network anomaly

17.3 Appendix III - W610D LED State Definition

Type	LED lights	State
Status indicator light	Yellow On	Charging
	Green On	Fully Charged
	Red and Yellow Blinking alternately	Low Battery
	Yellow Breathing Blinking	Missed calls or unread messages
	Yellow Blinking Quickly	Ringing

17.4 Appendix IV - W610D Menu Icons

Icon	Description
 Status	View the status of Manager, Network, Devices, and Accounts.
 Network	Connect to Manager/Base network
 Basic	Set preference settings.
 Contact	Access all contacts.
 Messages	View Voice Mails and SMS servers.

 CallLog	Access the call history list.
 Features	Set functions such as Call Forwarding, Auto Answer, Call Waiting, DND, Intercom, and Ban Anonymous Call.
 Application	Set up Memo and Export logs through USB drive
 Advanced	Set Security, Upgrade, and Factory Reset.

17.5 Appendix V - W610D Keyboard Character Query Table

Icon	Input Method	Keys	Characters Of Each Press
123	Number	1	1
		2	2
		3	3
		4	4
		5	5
		6	6
		7	7
		8	8
		9	9
		0	0
		* / @ [, + - _ = ' ? \ " ; () < > { } #	* . : / @ [, + - _ = ' ? \ " ; () < > { } #
		#	#

abc	Lowercase letters	1	@;()<>[]{}
		2	a b c
		3	d e f
		4	g h i
		5	j k l
		6	m n o
		7	p q r s
		8	t u v
		9	w x y z
		0	(space)
		☐	.,*/+:-:_'\
		#	#^!&\$% pound
		ABC	Upper Case Alphabets
2	A B C		
3	D E F		
4	G H I		
5	J K L		
6	M N O		
7	P Q R S		
8	T U V		
9	W Z Y X		
0	(space)		
☐	.,*/+:-:_'\		
#	#^!&\$%£¥¤~¡¿\$		
2aB	Number/Letter Keyboard		
		2	2 a b c A B C
		3	3 d e f D E F
		4	4 g h I G H I
		5	5 j k I J K L
		6	6 m n o M N O
		7	7 p q r s P Q R S

		8	8 t u v T U V
		9	9 w z y x W Z Y X
		0	0
		*	.*:/@[],+_-=?\~ ;()<>{}
		#	# ^!&\$%£¥α~¡¿§
aB2	Number/Letter Keyboard	1	1
		2	a b c A B C2
		3	d e f D E F3
		4	g h I G H I4
		5	j k l J K L5
		6	m n o M N O6
		7	p q r s P Q R S7
		8	t u v T U V8
		9	w z y x W Z Y X9
		0	0
		*	.*:/@[],+_-=?\~ ;()<>{}
		#	# ^!&\$%£¥α~¡¿§

17.6 Appendix VI - W710D LED Status Definition

Type	LED lights	State
WAN LED	On	Successfully connected to the local area network
	Flash	Network anomalies such as IP conflict or failure to obtain IP
	Off	No network cable inserted
ROLE LED	On	Device works as Manager
	Flash	Device works as Base
DECT LED	On	Base successfully connected to Manager

Type	LED lights	State
	Flash	There are active calls in the system
	Off	Base not connected to Manager