

Provide a Contact Closure During Ringing and/or Off-Hook

Use with Two-Button Emergency Phones!

The **LDB-3** Advanced Loop Detector monitors an analog phone line for ringing and/or an off-hook condition. A built-in relay can be activated when either of these conditions are detected. This is ideal for monitoring line status or for providing a visual indication of such.

The **LDB-3**'s disable input is ideal for two-button emergency phones, such as Viking's **E-1600-20A**, allowing "Info" button calls to be placed without activating the relay (turning on the emergency strobe light, camera, etc.)

Three DIP switches are provided for turning ring detection on or off, off-hook/loop detection on or off and for selecting a ring cadence mode which allows the relay to follow ringing or to remain activated during the off time of standard ring cadence.

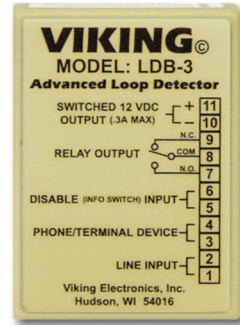

The **LDB-3** comes complete with a 12 VDC power adapter, and can also provide switched 12VDC 0.35 Amp output to power external lights, etc. during ringing and/or off-hook conditions.

Features

- Detects ring voltage and off hook loop current
- On/off switches for ring detection and off-hook/loop detection
- Screw terminal connections
- Selectable ring cadence mode (relay can remain on between rings)
- Wall mountable with foam tape (included) or screws (not included)
- Switched 12V DC output (follows relay activation for powering strobe lights, cameras, etc.)
- One set of (NO) normally open or (NC) normally closed relay contacts provided
- Disable input, ideal for use with two-button emergency phones (**E-1600-20A**), will not activate relay on "Info" calls, see DOD 215 for more information on the **E-1600-20A**

Applications

- Control a strobe or beacon light for ring indication
- Provide relay closures on ring and off-hook
- Trigger a security camera
- Trigger a tape recorder
- Phone "In Use" indicator

Specifications

Power: 120V AC to 12V DC adapter provided
Dimensions: 2.9" x 2.1" x 1.0" (74mm x 53mm x 25mm)
Shipping Weight: 0.86 lbs (0.4 kg)
Environmental: -15° F to 130° F (-26° C to 54° C) with 5% to 95% non-condensing humidity
Relay Contact Rating: .5A @ 125V AC/1A @ 30V DC
Maximum Current Draw Auxiliary 12V DC Output: 350mA
Minimum Loop Current: 15 mA
Disable/Info Switch Input: 50mA/80mW maximum
Ringer Equivalence: 0.5 A REN
Connections: 2 position and 11 position screw terminal blocks

Installation

A. Mount Using Screws (not included)

Step 1.	Unsnap the plastic cover and remove the top screw holding the circuit board.
Step 2.	Loosen the bottom screw and rotate the circuit board to the left, exposing the two mounting holes in the base.
Step 3.	Screw the base to the wall, etc. using (2) #6 flathead or sheetrock screws. Note: Make sure the screw heads are fully driven into the base to avoid shorting the circuit board leads.

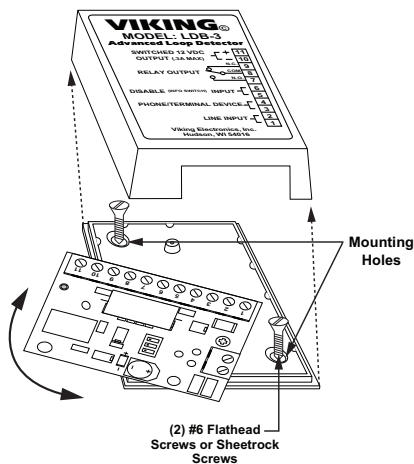

B. Mount Using the Included Tape

Step 1.	Clean the back of the LDB-3 and the surface you are mounting to with rubbing alcohol before mounting.
Step 2.	Remove the backing on one side of the tape and adhere to the LDB-3. Remove the rest of the backing and press unit firmly to surface you are mounting to.

C. Wiring the Power

IMPORTANT: Electronic devices are susceptible to lightning and power station electrical surges from both the AC outlet and the telephone line. It is recommended that a surge protector be installed to protect against such surges.

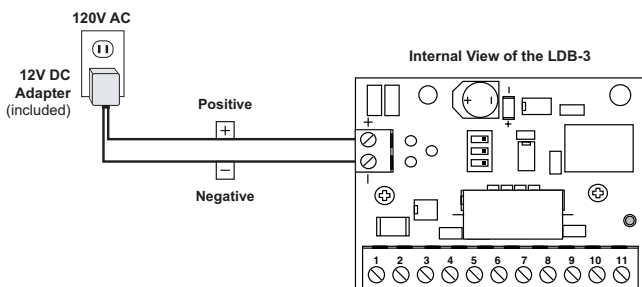

Programming

A. DIP Switches

Switch 1	Switch 3	Description
ON	OFF	Ring Detection Only (see section B).
OFF	ON	Off-Hook/Loop Current Detection Only (see section C).
ON	ON	Ring and Off-Hook/Loop Current Detection (see section D).

Switch 2	Ring Cadence Mode (see section E)
ON	Ring Cadence Mode ON - relay remains activated in between rings.
OFF	Ring Cadence Mode OFF - relay is activated only during ringing.

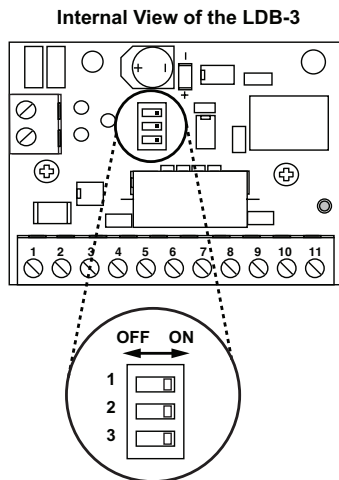

B. Ring Detection Only

Connect the incoming line to terminal block positions **1** and **2** as shown in the diagram. No terminal device (phone) is required. In this manner, the **LDB-3** can monitor for ringing any place along the ringing line.

C. Off-Hook / Loop Current Detection Only

The **LDB-3** must be placed between the phone line and the terminal device (phone) to be monitored. Connect the incoming line to positions **1** and **2** and connect the terminal device (phone) to positions **3** and **4**.

D. Ring and Off Hook / Loop Current Detection

If the application requires off-hook (loop) and ring detection, the **LDB-3** must be placed between the phone line and the terminal device (phone) to be monitored. Connect the incoming line to positions **1** and **2**, connect the terminal device (phone) to positions **3** and **4**.

E. Ring Cadence Mode

DIP switch **2** is used for switching between different ring detection modes. In the **OFF** position, the relay and switched 12VDC output will activate only while ring voltage is present and will turn off between rings. In the **ON** position, the relay and switched 12VDC output will remain on for up to 5.75 seconds after the ringing has stopped. This allows the relay and 12VDC to remain on between rings of a standard ring cadence. **Note:** To use the Ring Cadence Mode, ring detection **MUST** be enabled (DIP switch **1** - **ON**).

F. Relay Contacts

Normally open and normally closed relay contacts are available at terminal block positions **7**, **8**, **9**. The contacts are rated at .5A @ 125VAC/1A @ 30VDC. If contacts are driving an inductive load, place a suppression device at the load to snub high voltage spikes.

G. Switched 12V DC Output

The switched 12V DC output is a low current, 12-15VDC output that is turned on only while the ring/loop detect relay is activated. This switched power output is ideal for lighting strobe lights or powering up any device that draws less than 350mAmps. The positive side is available at terminal position **11**, and the negative side is at position **10**. Once all the line and load connections have been made, plug in the 115 V AC wall adapter, and replace the cover.

H. Disable Feature

By connecting the Disable/Info Switch input of the **LDB-3** to the "Info" switch of Viking's **E-1600-20A**, **E-1600-20A-EWP**, **E-1600-52A** or **E-1600-52A-EWP** Emergency Phone (not included), any outbound calls initiated from the "Info" button will not activate the loop detect relay. This way, only the "Help/Emergency" outbound calls will activate the relay. Cut one of the "Info" switch wires in half and connect each end to **LDB-3** terminals **5** and **6** as shown in the diagram at the right. **Note:** The Disable input is **NOT** polarity sensitive.

The "Disable" input can be connected to a remote switch, contact closure, etc. for deactivating the **LDB-3**'s internal relay. This can be useful to turn off the controlled device (strobe light, camera, etc.) Use the diagram shown at the right. If the relay has been activated by ringing, the switch will deactivate the relay and ringing must stop for a minimum of 6 seconds before the relay can be re-activated from a new incoming call.

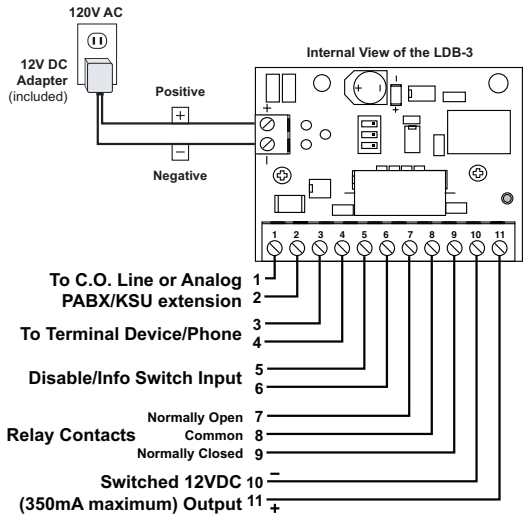

Rear View of E-1600-20A

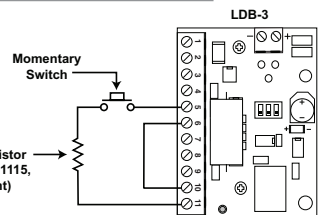
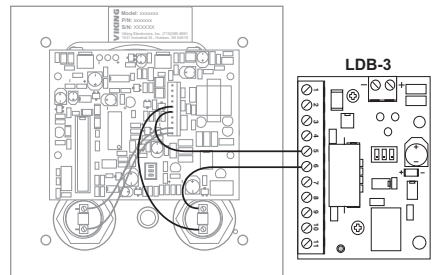

390 Ohm - 750 Ohm, 1/2 Watt Resistor
(Radio Shack part # 271-1114, 271-1115,
271-1116, 271-1117 or equivalent)

Warranty

IF YOU HAVE A PROBLEM WITH A VIKING PRODUCT, CONTACT VIKING TECHNICAL SUPPORT AT: 715-386-8666

Our Technical Support Department is available for assistance Monday to Friday 8:00am - 5:00pm central time. Before you call, please:

1. Know the model number, the serial number, and what software version you have (see serial label).
2. Have the Product Manual in front of you.
3. It is best if you are on site.

RETURNING PRODUCT FOR REPAIR

The following procedure is for equipment that needs repair:

1. Customer must contact Viking's Technical Support Department at 715-386-8666 to obtain a Return Authorization (RA) number. The customer MUST have a complete description of the problem, with all pertinent information regarding the defect, such as options set, conditions, symptoms, methods to duplicate problem, frequency of failure, etc.
2. Packing: Return equipment in original box or in proper packing so that damage will not occur while in transit. The original product boxes are not designed for shipping - an overpack box is required to prevent damage in transit. Static sensitive equipment such as a circuit board should be in an anti-static bag, sandwiched between foam and individually boxed. All equipment should be wrapped to avoid packing material lodging in or sticking to the equipment. Include ALL parts of the equipment. C.O.D. or freight collect shipments cannot be accepted. Ship cartons prepaid to:

**VIKING ELECTRONICS
1531 INDUSTRIAL STREET
HUDSON, WI 54016**

3. Return shipping address: Be sure to include your return shipping address inside the box. We cannot ship to a PO Box.
4. RA number on carton: In large printing, write the RA number on the outside of each carton being returned.

RETURNING PRODUCT FOR EXCHANGE

The following procedure is for equipment that has failed out-of-box (**within 10 days of purchase**):

1. Customer must contact Viking's Technical Support at 715-386-8666 to determine possible causes for the problem. The customer MUST be able to step through recommended tests for diagnosis.
2. If the Technical Support Product Specialist determines that the equipment is defective based on the customer's input and troubleshooting, a Return Authorization (RA) number will be issued. This number is valid for fourteen (14) calendar days from the date of issue.
3. After obtaining the RA number, return the approved equipment to your distributor. Please reference the RA number on the paperwork being shipped back with the unit(s), and also the outside of the shipping box. The original product boxes are not designed for shipping - an overpack box is required to prevent damage in transit. Once your distributor receives the package, they will replace the product over the counter at no charge. The distributor will then return the product to Viking using the same RA number.
4. **The distributor will NOT exchange this product without first obtaining the RA number from you. If you haven't followed the steps listed in 1, 2 and 3, be aware that you will have to pay a restocking charge.**

TWO YEAR LIMITED WARRANTY

Viking warrants its products to be free from defects in the workmanship or materials, under normal use and service, for a period of two years from the date of purchase from any authorized Viking distributor. If at any time during the warranty period, the product is deemed defective or malfunctions, return the product to Viking Electronics, Inc., 1531 Industrial Street, Hudson, WI., 54016. Customer must contact Viking's Technical Support Department at 715-386-8666 to obtain a Return Authorization (RA) number.

This warranty does not cover any damage to the product due to lightning, over voltage, under voltage, accident, misuse, abuse, negligence or any damage caused by use of the product by the purchaser or others. This warranty does not cover non-EWP products that have been exposed to wet or corrosive environments. This warranty does not cover stainless steel surfaces that have not been properly maintained.

NO OTHER WARRANTIES. VIKING MAKES NO WARRANTIES RELATING TO ITS PRODUCTS OTHER THAN AS DESCRIBED ABOVE AND DISCLAIMS ANY EXPRESS OR IMPLIED WARRANTIES OR MERCHANTABILITY OR FITNESS FOR ANY PARTICULAR PURPOSE.

EXCLUSION OF CONSEQUENTIAL DAMAGES. VIKING SHALL NOT, UNDER ANY CIRCUMSTANCES, BE LIABLE TO PURCHASER, OR ANY OTHER PARTY, FOR CONSEQUENTIAL, INCIDENTAL, SPECIAL OR EXEMPLARY DAMAGES ARISING OUT OF OR RELATED TO THE SALE OR USE OF THE PRODUCT SOLD HEREUNDER.

EXCLUSIVE REMEDY AND LIMITATION OF LIABILITY. WHETHER IN AN ACTION BASED ON CONTRACT, TORT (INCLUDING NEGLIGENCE OR STRICT LIABILITY) OR ANY OTHER LEGAL THEORY, ANY LIABILITY OF VIKING SHALL BE LIMITED TO REPAIR OR REPLACEMENT OF THE PRODUCT, OR AT VIKING'S OPTION, REFUND OF THE PURCHASE PRICE AS THE EXCLUSIVE REMEDY AND ANY LIABILITY OF VIKING SHALL BE SO LIMITED.

IT IS EXPRESSLY UNDERSTOOD AND AGREED THAT EACH AND EVERY PROVISION OF THIS AGREEMENT WHICH PROVIDES FOR DISCLAIMER OF WARRANTIES, EXCLUSION OF CONSEQUENTIAL DAMAGES, AND EXCLUSIVE REMEDY AND LIMITATION OF LIABILITY, ARE SEVERABLE FROM ANY OTHER PROVISION AND EACH PROVISION IS A SEPARABLE AND INDEPENDENT ELEMENT OF RISK ALLOCATION AND IS INTENDED TO BE ENFORCED AS SUCH.

Product Support: (715) 386-8666

Due to the dynamic nature of the product design, the information contained in this document is subject to change without notice. Viking Electronics, and its affiliates and/or subsidiaries assume no responsibility for errors and omissions contained in this information. Revisions of this document or new editions of it may be issued to incorporate such changes.