

snom

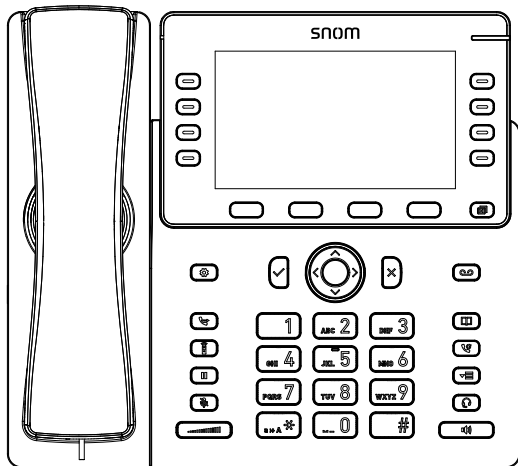

M58

SIP DECT Deskset

Quick Installation Guide

Important Safety Information



This symbol is to alert you to important operating or servicing instructions that may appear on the product or in this user's manual. Always follow basic safety precautions when using this product to reduce the risk of injury, fire, or electric shock.

Important Safety Instructions

When using your telephone equipment, basic safety precautions should always be followed to reduce the risk of fire, electric shock and injury, including the following:

1. This product should be installed by a qualified technician.
2. This product should only be connected to the host equipment and never directly to the network such as Public Switch Telephone Network (PSTN) or Plain Old Telephone Services (POTS).
3. Read and understand all instructions.
4. Follow all warnings and instructions marked on the product.
5. Unplug this product from the wall outlet before cleaning. Do not use liquid or aerosol cleaners. Use a damp cloth for cleaning.
6. Do not use this product near water such as near a bath tub, wash bowl, kitchen sink, laundry tub or swimming pool, or in a wet basement or shower.
7. Do not place this product on an unstable table, shelf, stand or other unstable surfaces.
8. Slots and openings in the back or bottom of the handset are provided for ventilation. To protect them from overheating, these openings must not be blocked by placing the product on a soft surface such as a bed, sofa or rug. This product should never be placed near or over a radiator or heat register. This product should not be placed in any area where proper ventilation is not provided.
9. This product should be operated only from the type of power source indicated on the marking label. If you are not sure of the type of power supplied at the premises, consult your dealer or local power company.
10. Do not allow anything to rest on the power cord. Do not install this product where the cord may be walked on.
11. Never push objects of any kind into this product through the slots in the handset because they may touch dangerous voltage points or create a short circuit. Never spill liquid of any kind on the product.

12. To reduce the risk of electric shock, do not disassemble this product, but take it to an authorized service facility. Opening or removing parts of the handset other than specified access doors may expose you to dangerous voltages or other risks. Incorrect reassembling can cause electric shock when the product is subsequently used.
13. Do not overload wall outlets and extension cords.
14. Unplug this product from the wall outlet and refer servicing to an authorized service facility under the following conditions:
 - A. When the power supply cord or plug is damaged or frayed.
 - B. If liquid has been spilled onto the product.
 - C. If the product has been exposed to rain or water.
 - D. If the product does not operate normally by following the operating instructions. Adjust only those controls that are covered by the operation instructions. Improper adjustment of other controls may result in damage and often requires extensive work by an authorized technician to restore the product to normal operation.
 - E. If the product has been dropped and the telephone base and/or handset has been damaged.
 - F. If the product exhibits a distinct change in performance.
15. Avoid using a telephone (other than cordless) during an electrical storm. There is a remote risk of electric shock from lightning.
16. Do not use the telephone to report a gas leak in the vicinity of the leak. Under certain circumstances, a spark may be created when the adapter is plugged into the power outlet, or when the handset is replaced in its cradle. This is a common event associated with the closing of any electrical circuit. The user should not plug the phone into a power outlet, and should not put a charged handset into the cradle, if the phone is located in an environment containing concentrations of flammable or flame-supporting gases, unless there is adequate ventilation. A spark in such an environment could create a fire or explosion. Such environments might include: medical use of oxygen without adequate ventilation; industrial gases (cleaning solvents; gasoline vapors; etc.); a leak of natural gas; etc.
17. Only put the handset of your telephone next to your ear when it is in normal talk mode.
18. The power adapters are intended to be correctly oriented in a vertical or floor mount position. The prongs are not designed to hold the plug in

place if it is plugged into a ceiling, under-the-table or cabinet outlet.

19. Use only the power cord indicated in this manual.
20. For pluggable equipment, the socket-outlet shall be installed near the equipment and shall be easily accessible.
21. CAUTION: Keep small metallic objects such as pins and staples away from the handset receiver.
22. WARNING: The product included (ITE) in this manual is to be connected only to PoE networks without routing to the outside plant.

SAVE THESE INSTRUCTIONS

<p>Power requirements</p> 	<p>Power adapter: VT05EUS05100 Input: 100~240V AC 50/60Hz 0.15A Output: 5.0 V DC @ 1A</p>
--	---

For cUL compliance only

Mesures de sécurité importantes



Ce symbole vous alertera d'informations importantes ou d'instructions d'entretien pouvant apparaître dans ce guide d'utilisation. Respectez toujours les mesures de sécurité et de sécurité de base lorsque vous utilisez ce produit, afin de réduire les risques de blessures, d'incendie, ou d'électrocution.

Mesures de sécurité importantes

Afin de réduire les risques d'incendie, de blessures corporelles ou d'électrocution, suivez toujours ces mesures préventives de base lorsque vous utilisez votre téléphone

1. Cet appareil doit être installé par un technicien qualifié.
2. Cet appareil doit être branché à un équipement hôte et jamais branché à un réseau, tel qu'un réseau PSTN publique ou un réseau téléphonique standard (POTS).
3. Lisez et comprenez bien toutes les instructions.
4. Observez toutes les instructions et mises en garde inscrites sur l'appareil.
5. Débranchez ce téléphone de la prise murale avant de le nettoyer. N'utilisez pas de nettoyeurs liquides ni en aérosol. N'utilisez qu'un

chiffon doux et légèrement humecté.

6. N'utilisez pas ce produit près de l'eau, tel que près d'un bain, d'un lavabo, d'un évier de cuisine, d'un bac de lavage ou d'une piscine, ou dans un sous-sol humide ou sous la douche.
7. Ne déposez pas ce téléphone sur un chariot, support ou table chancelants. L'appareil pourrait tomber et être sérieusement endommagé.
8. Le boîtier de l'appareil est doté de fentes et d'ouvertures d'aération situées à l'arrière ou en dessous. Afin d'empêcher la surchauffe, ces ouvertures ne doivent pas être obstruées en plaçant l'appareil sur un lit, divan, tapis ou autre surface similaires. Ne placez pas cet appareil à proximité d'un élément de chauffage ni d'une plinthe électrique. De plus, ne l'installez pas dans une unité murale ou un cabinet fermé qui ne possède pas d'aération adéquate.
9. Ne faites fonctionner cet appareil qu'avec le type d'alimentation indiqué sur les étiquettes de l'appareil. Si vous ne connaissez pas le voltage de votre maison, consultez votre marchand ou votre fournisseur d'électricité.
10. Ne déposez rien sur le cordon d'alimentation. Installez cet appareil dans un endroit sécuritaire, là où personne ne pourra trébucher sur la ligne d'alimentation ni le cordon téléphonique modulaire.
11. N'insérez jamais d'objets à travers les fentes et ouvertures de cet appareil, car ils pourraient toucher à des points de tension dangereux ou court-circuiter des pièces, ce qui constituerait un risque d'incendie ou d'électrocution. N'échappez pas de liquides dans l'appareil.
12. Afin de réduire les risques d'électrocution, ne démontez pas l'appareil, mais apportez-le plutôt à un centre de service qualifié s'il doit être réparé. En enlevant le couvercle, vous vous exposez à des tensions dangereuses ou autres dangers similaires. Un remontage inadéquat peut être à l'origine d'une électrocution lors d'une utilisation ultérieure de l'appareil.
13. Ne surchargez pas les prises de courant ni les rallonges électriques, car ceci peut constituer un risque d'incendie ou d'électrocution.
14. Débranchez cet appareil de la prise de courant et communiquez avec le département de service à la clientèle de Snom dans les cas suivants:
 - A. Lorsque le cordon d'alimentation est endommagé ou écorché.
 - B. Si du liquide a été échappé dans l'appareil.

- C. Si l'appareil a été exposé à une source d'humidité telle que la pluie ou l'eau.
 - D. Si l'appareil ne fonctionne pas normalement en suivant les directives du guide. N'ajustez que les commandes couvertes dans le guide d'utilisation, car un mauvais réglage de celles-ci peut être à l'origine de dommages, ce qui nécessiterait des réparations considérables pour remettre l'appareil à son état de fonctionnement normal.
 - E. Si l'appareil a été échappé ou son boîtier, endommagé.
 - F. Si le produit affiche une nette diminution de sa performance.
15. Évitez d'utiliser un téléphone (autre qu'un sans fil) pendant un orage. Les éclairs peuvent être à l'origine d'une électrocution.
 16. N'utilisez pas le téléphone pour rapporter une fuite de gaz à proximité de celle-ci. Sous certaines circonstances, une intempérie pourrait survenir lorsque l'adaptateur est branché à une prise de courant, ou lorsque le combiné est déposé sur le combiné. Ceci est un événement commun associé avec la fermeture d'un circuit électrique. L'utilisateur ne devrait pas brancher le téléphone dans une prise de courant, et ne devrait pas déposer le combiné chargé sur le socle, si le téléphone se trouve dans un environnement où la concentration de gaz inflammables, sans ventilation adéquate. Une étincelle dans ces endroits pourrait provoquer un incendie ou une explosion. Ces environnements pourraient être l'utilisation médicale de l'oxygène sans ventilation adéquate; le gaz industriel (dissolvants, vapeurs d'essence, etc.); une fuite de gaz naturel, etc.
 17. Placez uniquement le combiné de votre appareil près de votre oreille lorsqu'il est en mode de conversation normal.
 18. Les adaptateurs sont conçus pour être orientés en position verticale ou en position horizontale sur le plancher.
 19. N'utilisez que cordon d'alimentation et les piles indiquées dans ce guide d'utilisation.
 20. Pour les PRODUITS À BRANCHER À UNE PRISE DE COURANT, la prise de courant doit être installée près du produit, afin d'assurer une accessibilité sécuritaire à la prise de courant.
 21. MISE EN GARDE : Éloignez les petits objets métalliques tels que les broches de l'écouteur du combiné.
 22. AVERTISSEMENT : Le produit inclus (ITE) dans ce guide doit être

connecté uniquement aux réseaux PoE sans être acheminé vers l'installation extérieure.

CONSERVEZ CES INSTRUCTIONS

Alimentation électrique 	Adaptateur électrique : VT05EUS05100 Entrée : 100~240V AC 50/60Hz 0.15A Sortie : 5.0 V DC @ 1A
---	--

Compliance

FCC part 15

This device complies with Part 15 of the FCC rules. Operation is subject to the following two conditions: (1) This device may not cause harmful interference, and (2) this device must accept any interference received, including interference that may cause undesired operation.

This equipment has been tested and found to comply with the limits for a Class A digital device, pursuant to Part 15 of the FCC Rules. These limits are designed to provide reasonable protection against harmful interference when the equipment is operated in a commercial environment. This equipment generates, uses, and can radiate radio frequency energy and, if not installed and used in accordance with the instruction manual, may cause harmful interference to radio communications. Operation of this equipment in a residential area is likely to cause harmful interference in which case the user will be required to correct the interference at the user's expense.

Privacy of communications may not be ensured when using this phone.

Warning: Changes or modifications to this equipment not expressly approved by the party responsible for compliance could void the user's authority to operate the equipment.

Caution: To maintain the compliance with the FCC's/ISED's RF exposure guideline, place the base unit at least 20 cm from nearby persons.

For body-worn operation, this handset has been tested and meets the FCC/ISED RF exposure guidelines when used with the accessories supplied or designated for this product. Use of other accessories may not ensure compliance with FCC/ISED RF exposure guidelines.

FCC Part 68

Consumer Information:

- a. This equipment complies with Part 68 of the FCC rules and the requirements adopted by the ACTA. On the back or bottom of this equipment is a label that contains, among other information, a product identifier in the format **US:AAAEQ##TXXXX**. If requested, this number must be provided to the telephone company.
- b. An applicable certification jacks Universal Service Order Codes (USOC) for the equipment is provided (i.e., **RJ45C**) in the packaging with each piece of approved terminal equipment.
- c. A plug and jack used to connect this equipment to the premises wiring and telephone network must comply with the applicable FCC Part 68 rules and requirements adopted by the ACTA. A compliant LAN cable (RJ45) and modular plug is provided with this product. An RJ45 jack should normally be used for connecting to the SIP equipment through the LAN cable. See installation instructions for details.
- d. If this equipment causes harm to the telephone network, the telephone company will notify you in advance that temporary discontinuance of service may be required. But if advance notice isn't practical, the telephone company will notify the customer as soon as possible. Also, you will be advised of your right to file a complaint with the FCC if you believe it is necessary.
- e. The telephone company may make changes in its facilities, equipment, operations or procedures that could affect the operation of the equipment. If this happens the telephone company will provide advance notice in order for you to make necessary modifications to maintain uninterrupted service.
- f. Should you experience trouble with this equipment, please contact
Snom Technology GmbH
1 (339) 227-6160 (select option 2)
for repair or warranty information. If the equipment is causing harm to the telephone network, the telephone company may request that you disconnect the equipment until the problem is resolved.
- g. Please follow instructions for repairing if any (e.g. battery replacement section); otherwise do not alternate or repair any parts of device except specified.

- h. Connection to party line service is subject to state tariffs. Contact the state public utility commission, public service commission or corporation commission for information.
- i. **NOTICE:** If you have specially wired alarm equipment connected to the telephone line, ensure the installation of this product does not disable your alarm equipment.
If you have questions about what will disable alarm equipment, consult your telephone company or a qualified installer.
- j. This equipment is hearing aid compatible.

NOTICE: According to telephone company reports, AC electrical surges, typically resulting from lightning strikes, are very destructive to telephone equipment connected to AC power sources. To minimize damage from these types of surges, a surge arrester is recommended.

Industry Canada

This Class A digital apparatus complies with Canadian requirements: CAN ICES-3 (A)/NMB-3(A). Cet appareil numérique de la classe A est conforme à la norme CAN ICES-3 (A)/NMB-3(A) du Canada.

This device contains licence-exempt transmitter(s)/receiver(s) that comply with Innovation, Science and Economic Development Canada's licence-exempt RSS(s).

Operation is subject to the following two conditions: (1) this device may not cause interference, and (2) this device must accept any interference, including interference that may cause undesired operation of the device.

Privacy of communications may not be ensured when using this telephone.

The term "IC:" before the certification/registration number only signifies that the Industry Canada technical specifications were met.

This product meets the applicable Innovation, Science and Economic Development Canada technical specifications.

About this Guide

This quick installation guide provides a reference for the external features of the M58 SIP DECT Deskset and installation instructions.

The M18 SIP DECT Deskset is for use with the M500 Multi-cell SIP DECT Base Station. Please refer to the M58 SIP DECT Deskset User Manual for complete operation instructions.

For customer service or product information, visit our website at www.snomamericas.com.

Parts Checklist

Your telephone package contains the following items. Save your sales receipt and original packaging in the event warranty service is necessary.

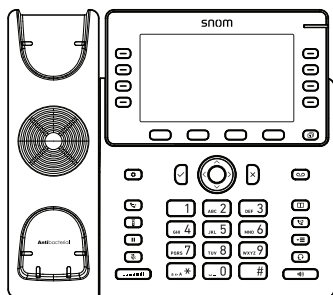

Deskset base

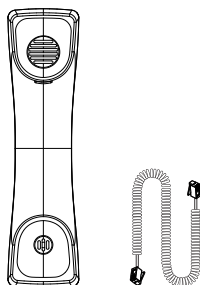

Handset and handset cord

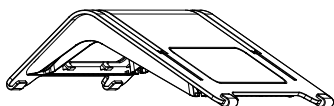

Deskset stand

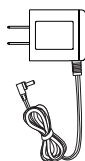

Power adapter

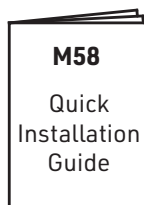

Quick Reference Guide

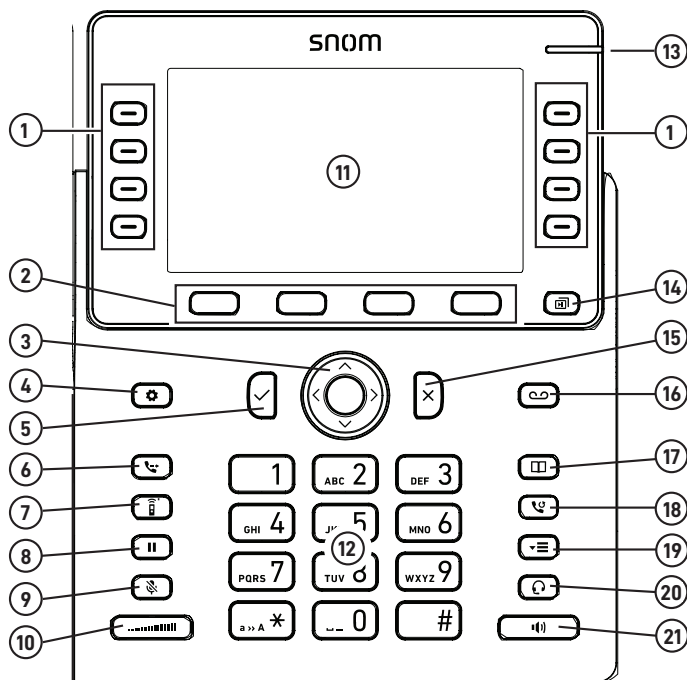

1	Programmable Feature Keys (PFKs)
2	Soft keys
3	○ MENU/Confirm key and ^ v < > navigation keys
4	Settings key
5	OK key
6	Transfer key
7	Intercom key
8	Hold key
9	Mute key
10	Volume key

11	Color screen
12	Alphanumeric keypad
13	Message waiting indicator
14	Next page key
15	Cancel key
16	Message key
17	Directory key
18	Redial key
19	Call History key
20	Headset key
21	Speaker key

Deskset Installation

This section assumes that your network infrastructure is established and that your

IP PBX phone service has been ordered and configured for your location.

Deskset installation involves both the deskset and the supplied power adapter. The deskset can be placed on a flat surface.

Avoid placing the deskset too close to:

- Communication devices such as television sets, DVD players, or other cordless telephones
- Excessive heat sources
- Noise sources such as a window with traffic outside, motors, microwave ovens, refrigerators, or fluorescent lighting
- Excessive dust sources such as a workshop or garage
- Excessive moisture
- Extremely low temperature
- Mechanical vibration or shock such as on top of a washing machine or work bench

Attaching the footstand

1

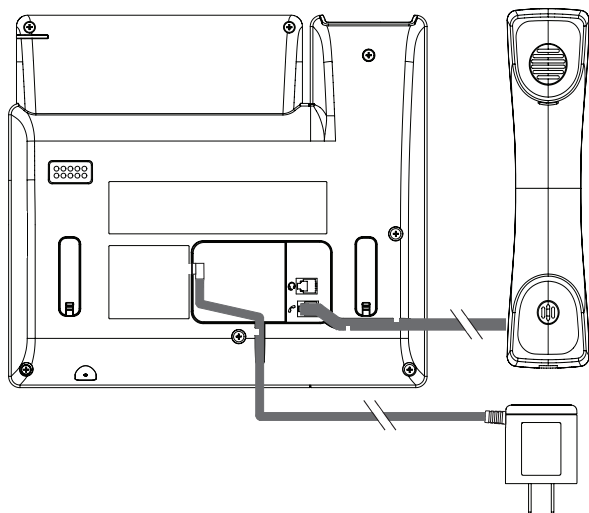

2

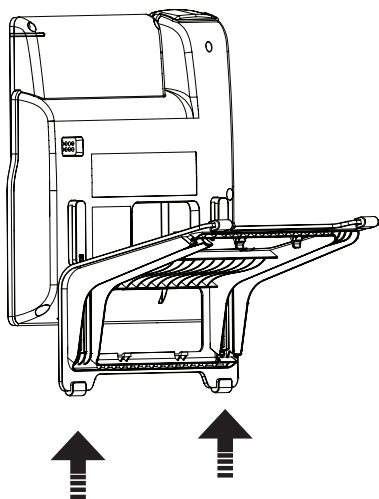

3

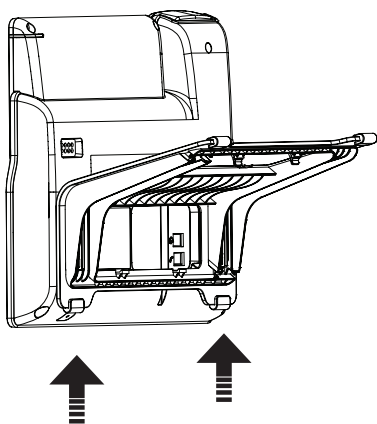

Connecting the phone

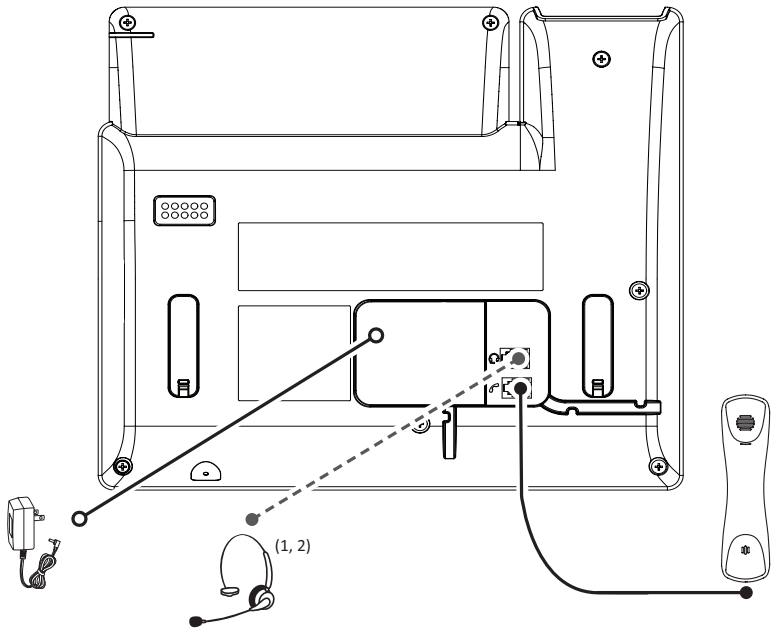

IMPORTANT INFORMATION

1. Use only the power adapter supplied with this product. To order a replacement power adapter, visit our website at www.snomamericas.com.
2. The power adapter is intended to be correctly oriented in a vertical or floor mount position. The prongs are not designed to hold the plug in place if it is plugged into a ceiling, under-the-table or cabinet outlet.

Deskset Registration

The deskset must be registered to the base station in order to make and receive calls.

When you power up the deskset for the first time, it will attempt to auto-register to the base station. Auto-registration will be successful only if you have set up the M500 configuration file with the deskset IPEI, or you have entered the IPEI on the Primary base station's WebUI.

Auto-registering the deskset to the base station

1. Make sure the base station is connected to power and the network.
2. If the deskset is displaying the following screen:

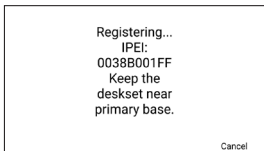

- a. Wait for the deskset to auto-register.
- b. If the IPEI has not been set up in the configuration file (provisioned), or the auto-registration is taking too long, press **Cancel**.

3. If the deskset is displaying the following screen:



- a. Press **Register**. The deskset displays the "Register via" menu.
- b. Press **^** or **v** to scroll to **Auto reg or IPEI input**, and press **Select**.
- c. Wait for the deskset to auto-register.
- d. If auto-registration is taking too long, press **Cancel**.

If registration is successful:

The deskset beeps and displays "Deskset registered", and then displays the idle screen.



If registration fails:

The deskset displays "Registration failed".

- a. Press **OK**.

The deskset displays "Device not registered to base station."

- b. Press **IPEI** to display the phone's IPEI and serial number. Give these numbers to your phone administrator.

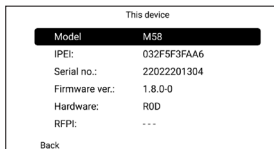

c. Press **Back**.

d. To manually register your deskset, follow the steps in “Manually registering via the LINK key on base station” on page 17 or “Manually registering via the Web UI” on page 18.

Registering by entering the deskset’s IPEI on the Web UI

To register the handset by entering the IPEI on the WebUI, you need to have at least one deskset registered in order to get the IP address of the base station; otherwise, you need to look up the IP address from your router that is connected to the M500.

The deskset displays the following screen that shows the deskset’s IPEI.

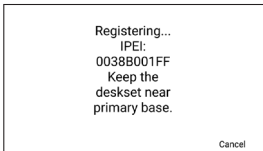

To register by entering the deskset’s IPEI on the Web UI:

1. Using the base station’s IP address, open the base station’s WebUI in a web browser.

NOTE: If your phone system is a multi-cell environment, you must open the WebUI of the Primary base station. To check, click **Status** in the WebUI sidebar, and then click **Base Status**. See which base station IP address is set to “Primary” mode. Open the WebUI for this IP address.

2. On the WebUI, click **Status** and then click **Cordless Registrations**.
3. Under **Register Handset**, enter a number for the **Handset ID**. Make sure that you enter a handset ID number that is not already used by another handset or deskset.
4. Enter the deskset’s **IPEI** (shown on the deskset’s screen), and then click **Register**.

The deskset displays the “Registering... IPEI...” screen.

If registration is successful:

The deskset beeps and displays “Deskset registered”, and then displays the idle screen.

If registration fails:

The deskset displays “Registration failed”.

- a. Press **OK**.

The deskset displays “Device not registered to base station.”



- b. To manually register your deskset, follow the steps in “Manually registering via the LINK key on base station” below or “Manually registering via the Web UI” on page 18.

Manually registering via the LINK key on base station

1. Make sure the base station is connected to power and the network.

NOTE: If your phone system is a multi-cell environment, you can only register the deskset to the Primary base station (as indicated by a steady green or slowly flashing red  SIP LED).

2. If the deskset is displaying the following screen:



- a. Press **Cancel**.
The deskset displays “Registration failed”.
- b. Press **OK**.
The deskset displays “Device not registered to base station.”



3. On the “Device not registered to base station.” screen, press **Register**.

4. With **LINK key on Base** highlighted, press **Select**.

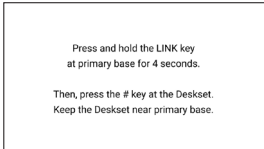
The handset displays the following screen:



5. Press and hold the LINK button on the base station for four seconds.

The  (power) and  (SIP) LEDs flash green.

6. Press the # key on the deskset to begin registration.

The deskset displays “Registering... Please Wait.”

If registration is successful:

The deskset beeps and displays “Deskset Registered”, and then displays the idle screen.



If registration fails:

The deskset beeps and displays “Registration failed”.

- a. Press **OK**.

The deskset displays “Device not registered to base station.”

- b. Make sure the deskset is near the base station.

- c. If your phone system is a multi-cell environment, make sure you are registering to the Primary base station. The SIP LED should be either steady green or slowly flashing red.
- d. Try to register again; go to step 3.

Manually registering via the Web UI

1. Make sure the base station is connected to power and the network.
2. If the deskset is displaying the following screen:

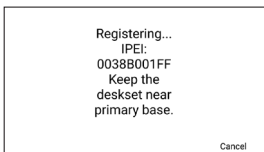

- a. Press **Cancel**.
The deskset displays "Registration failed".
- b. Press **OK**.
The deskset displays "Device not registered to base station."

3. On the "Device not registered to base station." screen, press **Register**.
4. Press **^** or **v** to scroll to **Manual start on WUI** and press **Select**.
The handset displays the following screen:

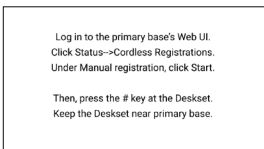

5. Using the base station's IP address, open the base station's WebUI in a web browser.
NOTE: If your phone system is a multi-cell environment, you must open the Primary base station's WebUI. To check, click **Status** in the WebUI sidebar, and then click **Base Status**. See which base station IP address is set to "Primary" mode. Open the WebUI for this IP address.
6. On the WebUI, click **Status** and then click **Cordless Registrations**.
7. Under **Manual registration**, click **Start**.
The WebUI displays "Success / Registration started".
8. Press the **#** key on the deskset to begin registration.
The deskset displays "Registering... Please Wait."

If registration is successful:

The deskset beeps and displays "Deskset Registered", and then displays the idle screen.

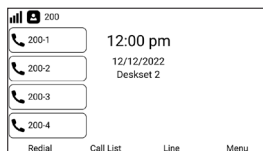

If registration fails:

The deskset beeps and displays "Registration failed".

- a. Press **OK**.

The deskset displays "Device not registered to base station."

- b. Make sure the deskset is near the base station.
- c. If your phone system is a multi-cell environment, make sure you are registering to the Primary base station. Click **Status** in the WebUI sidebar, and then click **Base Status**. See which base station IP address is set to "Primary" mode. Open the WebUI for this IP address.
- d. Try to register again; go to step 3.

Deregistering the deskset

Before using the deskset with a different base station, you must deregister the deskset from the base station to which it is currently registered.

To deregister the deskset:

1. Press the **MENU/Confirm** key.
2. Press **▼** to select  (Settings), then press **OK**.
3. Press **▲** or **▼** to scroll to **User settings**, and press **Enter**.
4. Press **▲** or **▼** to scroll to **Registration**, and press **Enter**.
5. Press **▲** or **▼** to scroll to **Deregistration**, and press **Select**.

The "Deregistration" screen appears, showing the list of registered desksets.

Your deskset is indicated by **.

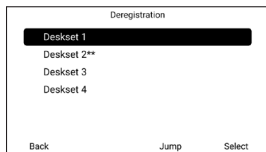

6. Press **▲** or **▼** to select the deskset you want to deregister, and press **Select**.
7. Enter the PIN and press **OK**. The default PIN is 0000.
The deskset beeps and displays "Deskset is deregistered".

To deregister the deskset using the WebUI:







1. Using the base station's IP address, open the base station's WebUI in a web browser.



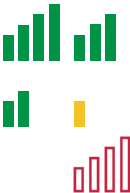







NOTE: If your phone system is a multi-cell environment, you must open the Primary base station's WebUI. Click **Status** in the WebUI sidebar, and then click **Base Status**. See which base station IP address is set to "Primary" mode. Open the WebUI for this IP address.

2. On the WebUI, click **Status** and then click **Cordless Registrations**.
3. Under **Cordless Registrations**, click **Deregister** next to the Deskset ID you want to deregister.

Screen icons

The following screen icons indicate your phone's current status:

Icon	Status
	Indicates signal strength, from one bar (weak) to four bars (strong). Flashes when out of range.
	The microphone is muted.
	The keypad is locked.
	The ringer is muted.
	Silent mode is enabled.
	Corded headset is in use.
	Bluetooth device status - connected headset.

Icon	Status
	Call Forward All is on.
	The speakerphone is active.
	Call History log entry - Dialed call.
	Call History log entry - Received call.
	Call History log entry - Missed call.
	Default outgoing line status - Registered.
	Default outgoing line status - Unregistered.
	Default outgoing line status - Disabled.
	Do Not Disturb is on.
	<p>Index number assigned to shared calls. Applicable to shared calls only.</p> <p>This icon is displayed on the Call List and call screens.</p>
	Base station broadcasting latest deskset firmware as auto firmware update.

Maintenance

Taking care of your telephone

- Your base station and cordless deskset contain sophisticated electronic parts, so you must treat them with care.
- Avoid rough treatment.
- Place the handset down gently.
- Save the original packing materials to protect your products if you ever need to ship them.

Avoid water

- You can damage your cordless telephone if it gets wet. Do not use the handset in the rain, or handle it with wet hands. Do not install the base station and deskset near a sink, bathtub or shower.

Electrical storms



- Electrical storms can sometimes cause power surges harmful to electronic equipment. For your own safety, take caution when using electric appliances during storms.

Cleaning your telephone

- Your products have a durable plastic casing that should retain its luster for many years. Clean it only with a soft cloth slightly dampened with water or a mild soap.
- Do not use excess water or cleaning solvents of any kind.

Remember that electrical appliances can cause serious injury if used when you are wet or standing in water. If the telephone base should fall into water, **DO NOT RETRIEVE IT UNTIL YOU UNPLUG THE POWER CORD FROM THE WALL**, then pull the unit out by the unplugged cord.

Technical Specifications

RF frequency band	1921.536-1928.448 MHz
Channels	5
Operating temperature	32-104 °F (0-40 °C)
Power requirements  	Power adapter: VT05EUS05100 Input: 100~240V AC 50/60Hz 0.15A Output: 5.0 V DC @ 1A
Connectors	Two RJ9-4P4C (handset, headset)
Bluetooth range	Up to 10m

VTECH COMMUNICATIONS, INC.

Tigard, Oregon 97223, USA.

Copyright © 2022 Snom Technology GmbH. All Rights Reserved.

v20220802 Version 2, 08/22