

Yealink

USB PTZ Camera UVC50

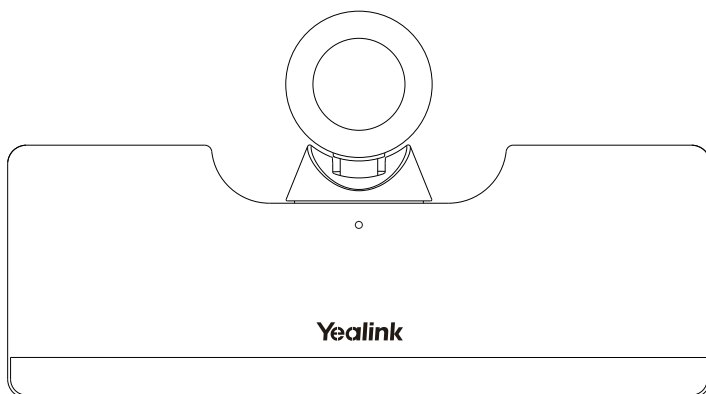

English | 简体中文

Quick Start Guide(V1.4)

Package Contents

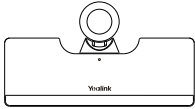

UVC50

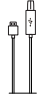

2.5m
USB Cable

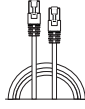

7.5m
Ethernet Cable

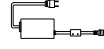

Power Adapter
48V/0.7A

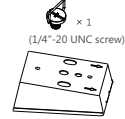

VESA Accessory
(1/4"-20 UNC screw)

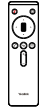

VCR20
Remote Control



Velcro×2
(One Velcro is on the bracket)



Cable Tie×5



Camera Lens
Privacy cover

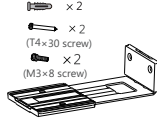

Mounting Bracket
and Accessories



UVC50
Quick Start Guide

💡 We recommend that you use the accessories provided or approved by Yealink. The use of unapproved third-party accessories may result in poor performance.

UVC50 Installation

• Put on a Flat Surface

You can put the UVC50 on the conference table, and make sure that the angle of inclination of the UVC50 is not more than 5 degrees to ensure proper operation.

• Mount on the top of the TV

Choose the following installation method when the thickness of the TV is between 1mm and 36mm.

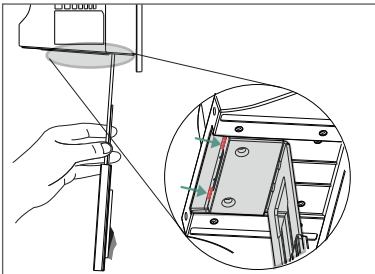
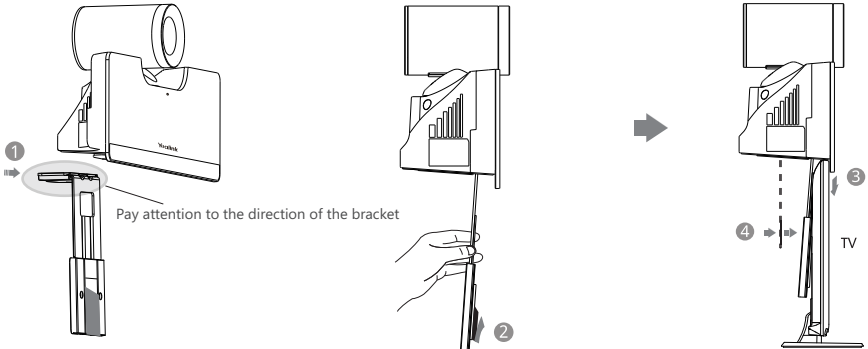

💡 If your UVC50 cannot be mounted on the top of the TV when the bracket has reached the given location, remove the bracket, and then convert the direction of the bracket. Refer to the following section for more information.

Choose the following installation method when the thickness of the TV is between 37mm and 77mm.

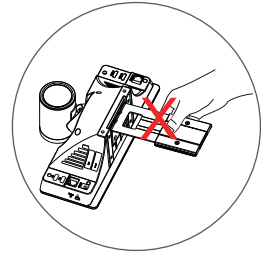
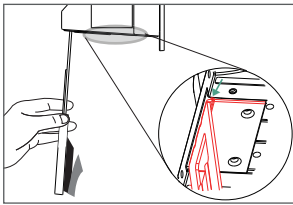
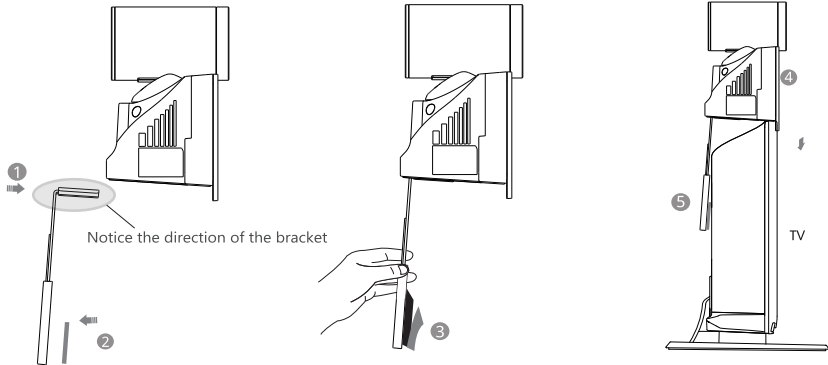

💡 If your UVC50 cannot be mounted on the top of the TV when the bracket has reached the edge of the UVC50, choose another installation method.

💡 Do not pick up the bracket which is connected with a UVC50, the UVC50 may fall down in this situation.

● Mount on the Wall

The recommended height is 1.55m-1.85m above the ground.

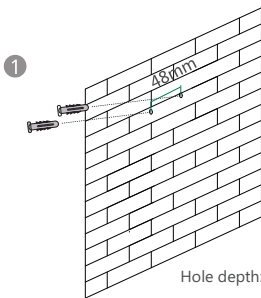

Hole depth: 30mm

Hole diameter: 6mm



2 Screw specification: T4×30

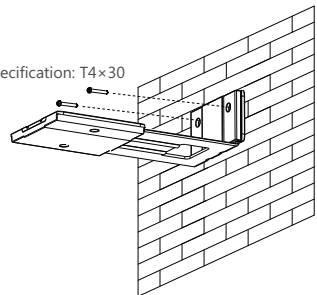

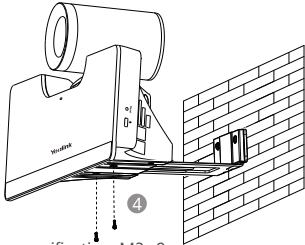
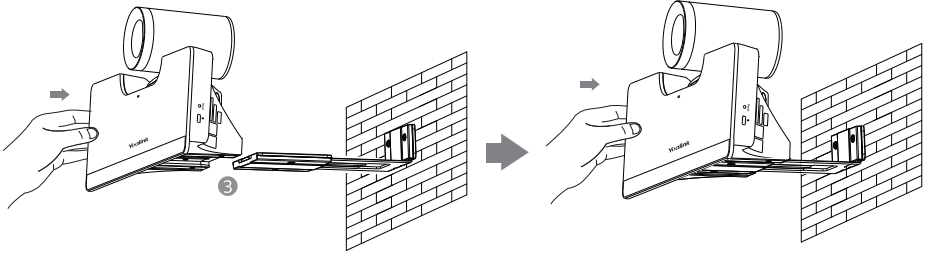

Screw specification: M3×8

• Mount on the Ceiling

If you choose the ceiling-mounted installation, you need to purchase a bracket separately.

The bracket must meet the following requirements:

- Bear the weight of at least 10.5kg (23.15 lb.) and the thickness must be between 2mm (0.08 in.) and 3 mm (0.12 in.).
- Comes with a location pillar, which can be inserted into the location hole of the VESA accessory.
- The distance between the screw on the bracket and the location pillar must be 14 mm (0.55 in.).

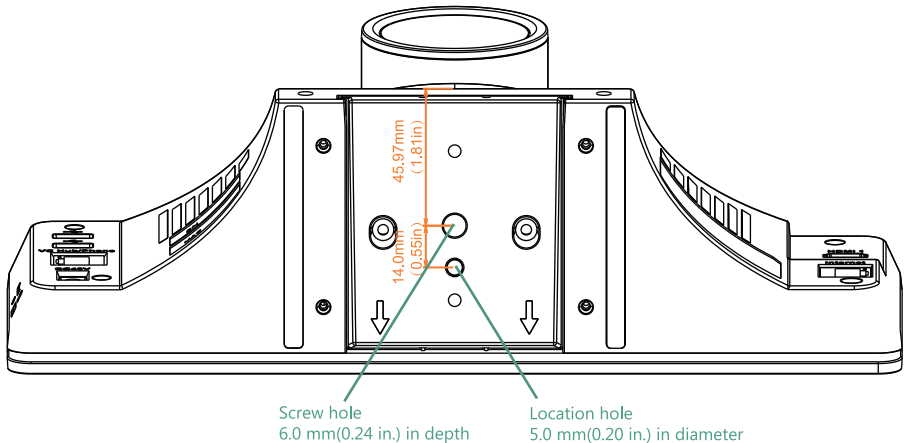

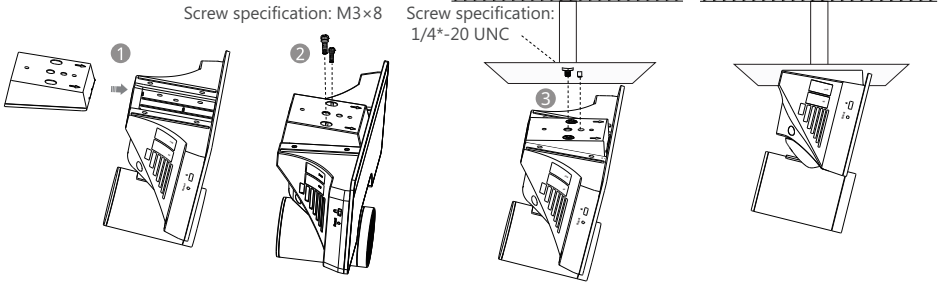

● **Mount onto a TV Stand or a Tripod**

You need to purchase a TV stand or a tripod separately. The TV stand or the tripod has the same requirements as the bracket used when mounting the UVC50 on the ceiling. The installation steps are the same as the steps of mounting on the ceiling.

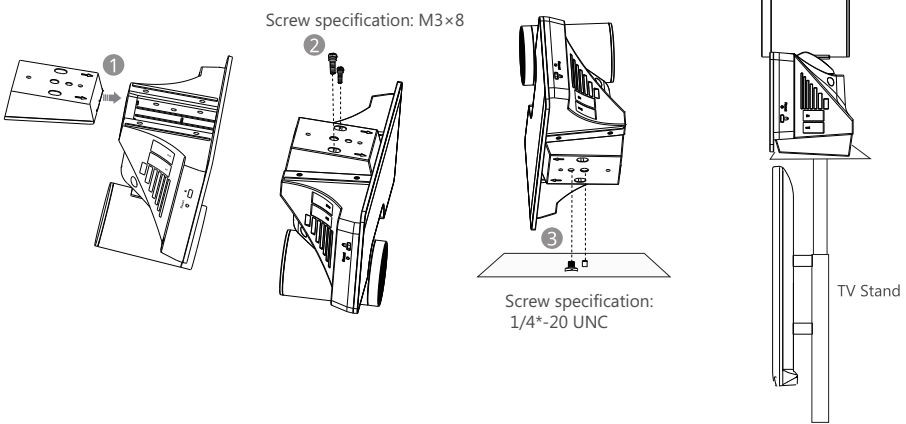

Cable Ties Installation

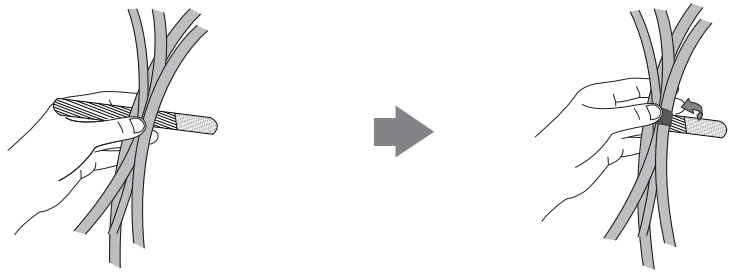

Hardware Interface Instructions

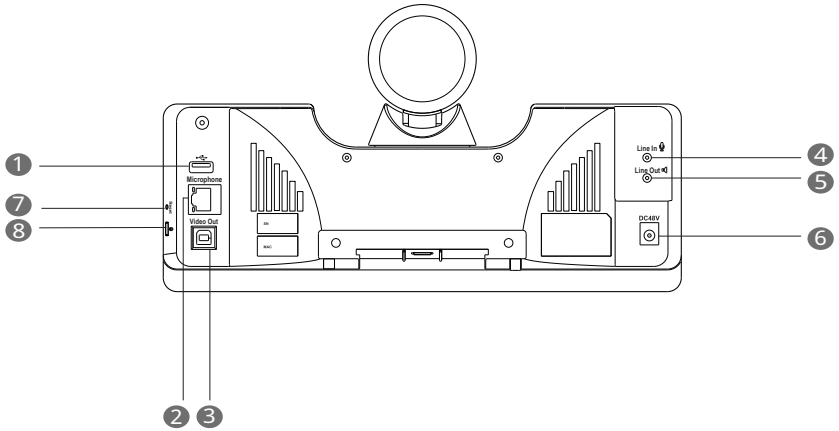

- 1 USB: insert DD10 to connect to CPW90
- 2 Microphone(optional): connect to VCM34
- 3 Video Out: connect to a PC as video output
- 4 Line In: connect to an audio input device using an audio cable (3.5mm)
- 5 Line Out: connect to an audio output device using an audio cable (3.5mm)
- 6 DC48V: connect to the power adapter
- 7 Reset: reset the UVC50 to factory defaults
- 8 Security slot: connect a universal security cable to the UVC50 so that you can lock the UVC50 down.

UVC50 Connection

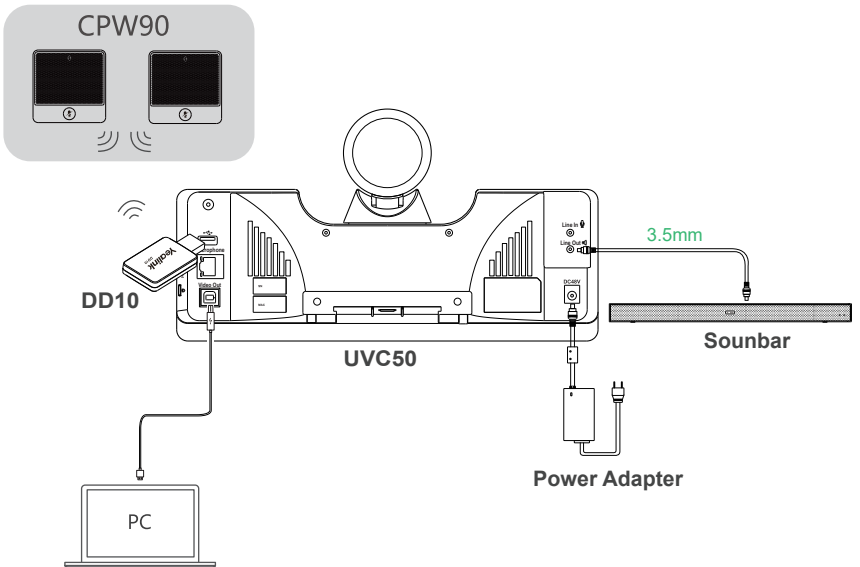

 The priority of audio input channel is: Microphone(VCM34) >USB(CPW90)>line-in.

 The cable should be replaced at once if its skin is broken.

LED Indicator Instructions

LED indicators on the UVC50:

LED Status	Description
Solid green	The UVC50 is active.
Solid red	The UVC50 is in sleep mode.
Solid orange	The UVC50 is initializing.
Flashing orange	The UVC50 is upgrading firmware.

包装清单

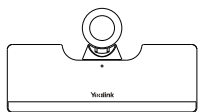

UVC50



2.5m
USB线

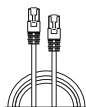

7.5m 网线

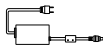

电源适配器
48V/0.7A

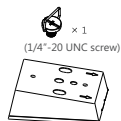

VESA 配件
(1/4" UNC screw)

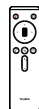

VCR20遥控器



魔术贴x2
(一套已贴在支架上)



束线带x 5



镜头隐私盖

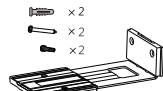

支架配件
(用于安装主机)



UVC50
快速入门指南

 我们推荐使用由Yealink提供或经Yealink认可的配件和线缆，使用未经认可的第三方配件和线缆可能会导致性能下降。

安装UVC50

• 平放安装

将终端摆放在水平桌面。如果桌面略有倾斜，请保证倾斜角小于 5° ，以保证终端的摄像机云台正常运转。

• 挂装

当电视厚度范围为1mm-36mm时，进行以下步骤：

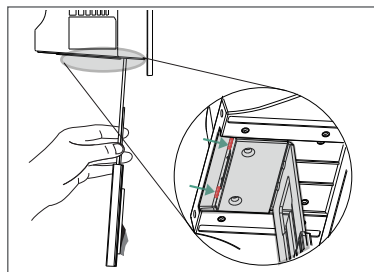
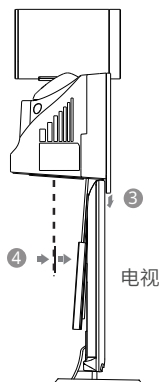
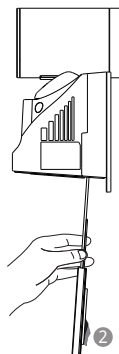

 当支架接触到限位点，还不能放置在电视顶上时，请取出支架反向装配。请参阅下文了解更多信息。

当电视厚度范围为37mm-77mm时, 进行以下步骤:

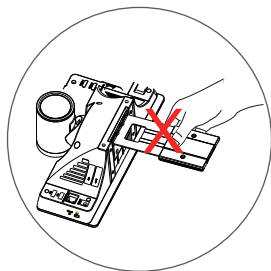
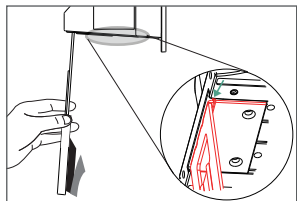
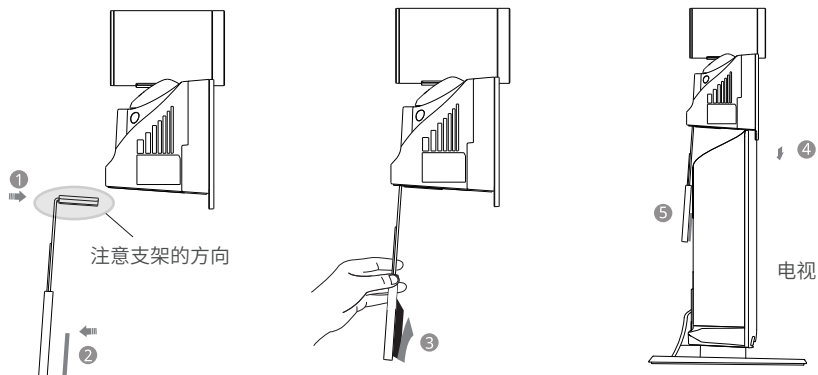

💡 当支架与底壳边缘位置齐平, 还不能放置在电视顶上时, 请使用其他安装方式。

💡 请勿手持支架拿起机器, 有掉落风险。

• 墙装

你可以用支架将终端安装在墙上, 终端安装高度建议范围为1.55-1.85m。

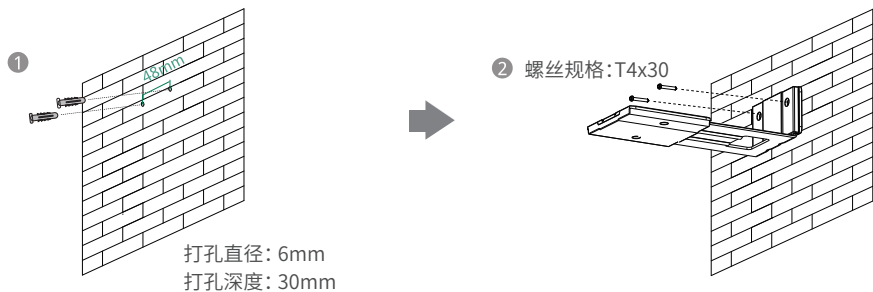

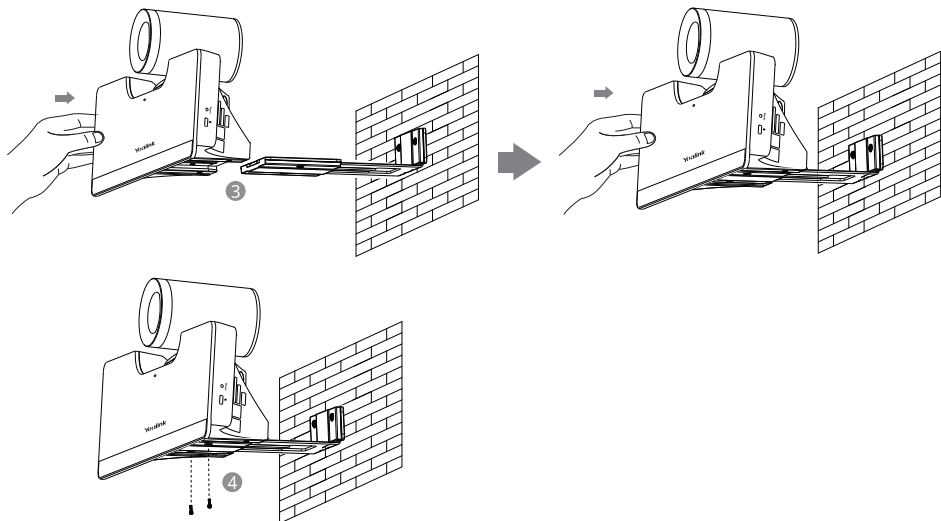

螺丝规格:M3x8

• 吊装

用户可以自行选购支架来将终端倒挂在天花板上，选购的支架必须满足以下条件：

- 承重至少为10.5kg，厚度建议为2mm-3mm。
- 支架配套一个定位柱，定位柱用来插入VESA配件的定位孔中。
- 支架上的英制螺钉和定位柱的直线距离必须为14mm。

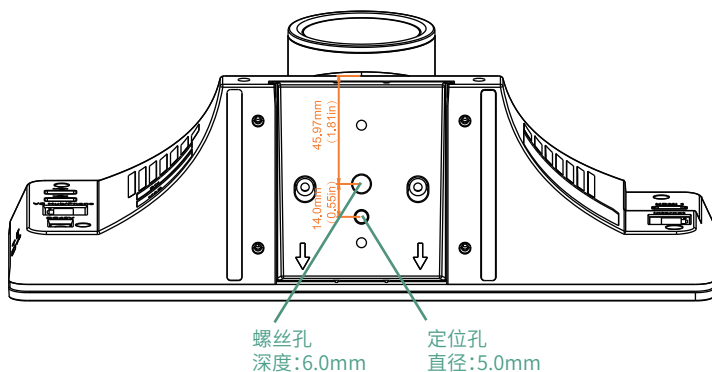

螺丝规格：M3x8 螺丝规格：
1/4-20UNC英制螺钉

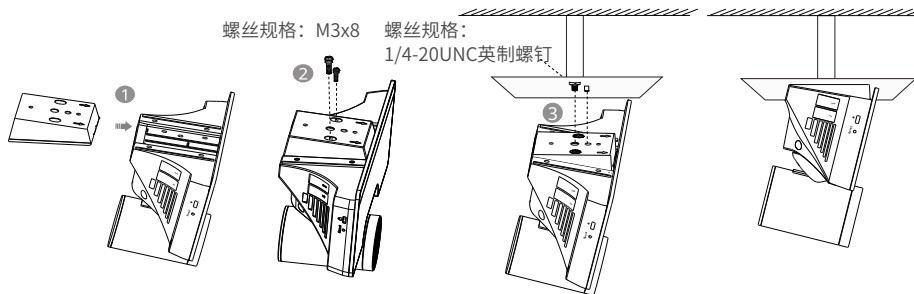

• 电视架或三脚架安装

用户可以自行选购电视架或三脚架来固定终端，电视架或三脚架的选购要求与使用吊装方式时的支架要求相同。电视架或三脚架安装步骤与吊装步骤相同。

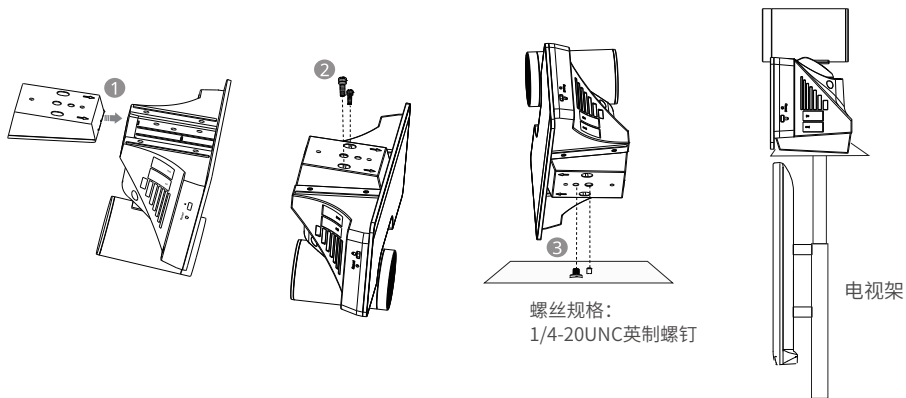

安装束线带

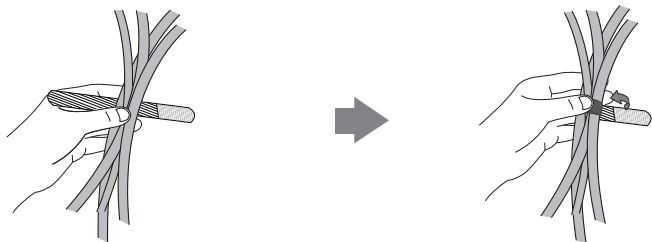

硬件接口介绍

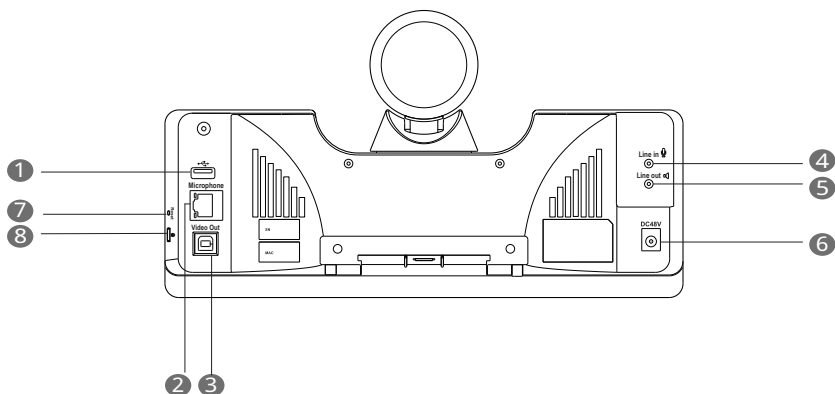

- ① USB: 插入BT42配对CPW90-BT蓝牙麦
- ② 麦克风: 连接VCM34
- ③ 视频输出: 连接电脑作为视频输出
- ④ 音频线性输入: 使用3.5mm音频接头线连接音频输出设备
- ⑤ 音频线性输出: 使用3.5mm音频接头线连接音频输出设备
- ⑥ 电源接口: 连接电源适配器
- ⑦ 重置键: 重置UVC50到出厂设置
- ⑧ 安全锁孔: 将主机锁在固定位置

连接UVC50

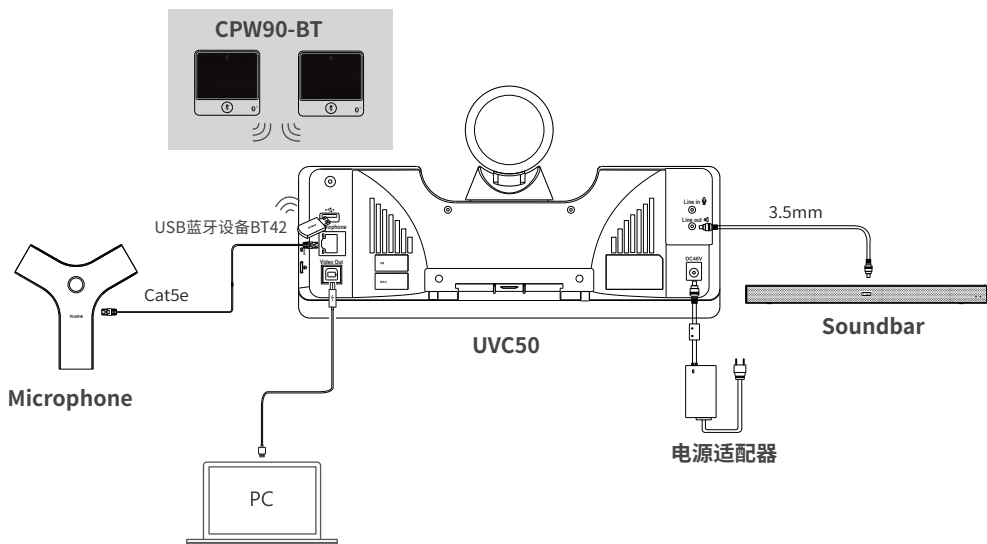

- 💡 音频输入通道优先级顺序: 麦克风 (VCM34) > USB (CPW90-BT) > Line-in.
- 💡 更多关于如何使用CPW90-BT蓝牙无线麦, 请参阅 Yealink CPW90-BT Bluetooth Wireless Microphones Quick Start Guide(CN, EN).
- 💡 如果使用过程中发现线缆破损, 请立即更换。

指示灯介绍

UVC50 指示灯介绍如下:

指示灯状态	说明
绿灯常亮	UVC50处于正常工作状态
红灯常亮	UVC50处于休眠状态
橙色灯常亮	UVC50处于启动/等待中状态
橙色灯闪烁	UVC50固件更新中

Regulatory Notices

Operating Ambient Temperatures

- Operating temperature: +32 to 104°F (0 to 40°C)
- Relative humidity: 5% to 90%, noncondensing
- Storage temperature: -22 to +160°F (-30 to +70°C)

Warranty

Our product warranty is limited only to the unit itself, when used normally in accordance with the operating instructions and the system environment. We are not liable for damage or loss resulting from the use of this product, or for any claim from a third party. We are not liable for problems with Yealink device arising from the use of this product; we are not liable for financial damages, lost profits, claims from third parties, etc., arising from the use of this product.

Explanation of the symbols

● DC symbol

 is the DC voltage symbol.

● WEEE Warning symbol

 To avoid the potential effects on the environment and human health as a result of the presence of hazardous substances in electrical and electronic equipment, end users of electrical and electronic equipment should understand the meaning of the crossed-out wheeled bin symbol. Do not dispose of WEEE as unsorted municipal waste and have to collect such WEEE separately.

Restriction of Hazardous Substances Directive (RoHS)

All adapter devices comply with the requirements of the EU RoHS Directive. Statements of compliance can be obtained by contacting support@yealink.com.

Safety Instructions

Save these instructions. Read these safety instructions before use!

General Requirements

- Before you install and use the device, read the safety instructions carefully and observe the situation during operation.
- During the process of storage, transportation, and operation, please always keep the device dry and clean, avoid collision and crash.
- Please attempt not to dismantle the device by yourself. In case of any discrepancy, please contact the appointed maintenance center for repair.
- Please refer to the relevant laws and statutes while using the device. Legal rights of others should be respected as well.

Environmental Requirements

- Place the device at a well-ventilated place. Do not expose the device under direct sunlight.
- Keep the device dry and free of dusts.
- Do not place the device on or near any inflammable or fire-vulnerable object, such as rubber-made materials.
- Keep the device away from any heat source or bare fire, such as a candle or an electric heater.

Operating Requirements

- Do not let a child operate the device without guidance.
- Do not let a child play with the device or any accessory in case of accidental swallowing.
- Please use the accessories provided or authorized by the manufacturer only.
- The power supply of the device shall meet the requirements of the input voltage of the device. Please use the provided surge protection power socket only.
- Before plugging or unplugging any cable, make sure that your hands are completely dry.
- Do not spill liquid of any kind on the product or use the equipment near water, for example, near a bathtub, washbowl, kitchen sink, wet basement or near a swimming pool.
- During a thunderstorm, stop using the device and disconnect it from the power supply. Unplug the power plug and the Asymmetric Digital Subscriber Line (ADSL) twisted pair (the radio frequency cable) to avoid lightning strike.

- If the device is left unused for a rather long time, disconnect it from the power supply and unplug the power plug.
- When there is smoke emitted from the device, or some abnormal noise or smell, disconnect the device from the power supply, and unplug the power plug immediately.
- Contact the specified maintenance center for repair.
- Do not insert any object into equipment slots that is not part of the product or auxiliary product.
- Before connecting a cable, connect the grounding cable of the device first. Do not disconnect the grounding cable until you disconnect all other cables.

Cleaning Requirements

- Before cleaning the device, disconnect it from the power supply.
- Use a piece of soft, dry and anti-static cloth to clean the device.
- Keep the power plug clean and dry.

Troubleshooting

The unit cannot supply power to device other than Yealink device.

There is a bad connection with the plug.

1. Clean the plug with a dry cloth.
2. Connect it to another wall outlet.

The usage environment is out of operating temperature range.

1. Use in the operating temperature range.

The cable between the unit and the Yealink device is connected incorrectly.

1. Connect the cable correctly.
2. You cannot connect the cable properly.

1. You may have connected a wrong Yealink device.

2. Use the correct power supply.

Some dust, etc., may be in the port.

1. Clean the port.

Contact your dealer or authorized service facility for any further questions.

FCC Statement

This device complies with part 15 of the FCC Rules. Operation is subject to the following

two conditions: (1) this device may not cause harmful interference, and (2) this device must accept any interference received, including interference that may cause undesired operation.

Any Changes or modifications not expressly approved by the party responsible for compliance could void the user's authority to operate the equipment.

IC Statement

This device complies with Industry Canada's licence-exempt RSSs. Operation is subject to the following two conditions:

- (1) this device may not cause interference; and
- (2) this device must accept any interference, including interference that may cause undesired operation of the device. CAN ICES-3(B)

Le présent appareil est conforme aux CNR d'Industrie Canada applicables aux appareils radio exempts de licence. L'exploitation est autorisée aux deux conditions suivantes :

- (1) l'appareil ne doit pas produire de brouillage;
- (2) l'utilisateur de l'appareil doit accepter tout brouillage radioélectrique subi, même si le brouillage est susceptible d'en compromettre le fonctionnement.NMB-3(B)

Contact Information

YEALINK NETWORK TECHNOLOGY CO., LTD.
309, 3rd Floor, No.16, Yun Ding North Road, Huli District, Xiamen City, Fujian, P.R. C
YEALINK (EUROPE) NETWORK TECHNOLOGY B.V.
Strawinskylaan 3127, Atrium Building, 8th floor, 10772X Amsterdam, The Netherlands
YEALINK (USA) NETWORK TECHNOLOGY CO., LTD.
999 Peachtree Street Suite 2300, Fulton, Atlanta, GA, 30309, USA
Made in China

About Yealink

Yealink is a global leading provider of enterprise communication and collaboration solutions, offering video conferencing service to worldwide enterprises. Focusing on research and development, Yealink also insists on innovation and creation. With the outstanding technical patents of cloud computing , audio, video and image processing technology, Yealink has built up a panoramic collaboration solution of audio and video conferencing by merging its cloud services with a series of endpoints products. As one of the best providers in more than 140 countries and regions including the US, the UK and Australia, Yealink ranks No.1 in the global market share of SIP phones shipments.

Technical Support

Visit Yealink WIKI (<http://support.yealink.com/>) for the latest firmware, guides, FAQ, Product documents, and more. For better service, we sincerely recommend you to use Yealink Ticketing system (<https://ticket.yealink.com>) to submit all your technical issues.

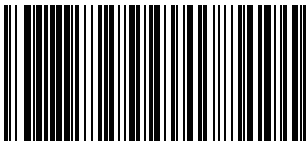

UVCS0-EN+CN



Web: www.yealink.com
Copyright©2020 YEALINK(XIAMEN) NETWORK
TECHNOLOGY CO.,LTD.All rights reserved.