

Grandstream Networks, Inc.

GXV3611IR_HD v2

Indoor Infrared Fixed Dome HD IP Camera



TABLE OF CONTENTS
GXV3611IR_HD User Manual

WELCOME.....	5
SAFETY COMPLIANCES	6
FCC CAUTION	7
RF EXPOSURE INFORMATION (SAR)	7
WARRANTY	8
CONNECT YOUR GXV3611IR_HD	9
EQUIPMENT PACKAGE CONTENTS.....	9
CONNECTING THE GXV3611IR_HD.....	10
PRODUCT OVERVIEW	11
GXV3611IR_HD CAMERA.....	11
GXV3611IR_HD SPECIFICATIONS.....	13
INSTALLATION GUIDE	14
MINIMUM RECOMMENDED COMPUTER SYSTEM REQUIREMENT.....	14
CONFIGURE THE GXV3611IR_HD VIA WEB BROWSER	14
Windows Platform:.....	15
Apple Platform:	17
CONNECT TO THE CAMERA USING STATIC IP	19
GXV3611IR_HD APPLICATION SCENARIOS.....	20
BATTERY POWER OR NO NETWORK	20
LAN W/O INTERNET	21
LAN WITH INTERNET	22
GXV3611IR_HD APPLICATION PERIPHERAL CONNECTION	23
GXV3611IR_HD HOME WEB PAGE	25
GXV3611IR_HD CONFIGURATION & LANGUAGE PAGE.....	26
BASIC SETTINGS EXPLANATION	27
SYSTEM SETTINGS PAGE	27
VIDEO & AUDIO SETTING PAGE	28
OSD SETTING PAGE.....	29
CMOS SETTINGS PAGE.....	31
NETWORKING SETTING PAGE	32
DDNS SETTINGS PAGE	33
SIP SETTING PAGE.....	34
STATUS PAGE.....	37
ADVANCED SETTINGS EXPLANATION	38
USER MANAGEMENT PAGE.....	38
MAINTENANCE PAGE.....	39
SMTP SETTING PAGE (EMAIL ALARM).....	41
FTP SETTINGS PAGE (UPLOAD ALARM).....	42
PRIVACY MASKS	43
ALARM SERVER SETTING PAGE	44
TIME LAPSE PHOTOGRAPHY	44
ALARM EVENT	46
MOTION DETECTION.....	48
SYSLOG SETTINGS.....	50
RECORD.....	51
LIVE STORAGE.....	51
SOFTWARE UPGRADE.....	53
INSTRUCTIONS FOR LOCAL FIRMWARE UPGRADE USING TFTP SERVER:	54
CONFIGURATION FILE DOWNLOAD	54

RESTORE FACTORY DEFAULT SETTING	55
RESET FROM WEB INTERFACE (SOFT RESET)	55
RESET VIA BUTTON (HARD RESET).....	55
IP SURVEILLANCE FAQ	56

TABLE OF FIGURES
GXV3611IR_HD USER MANUAL

FIGURE 1: GXV3611IR_HD OUTSIDE VIEW	11
FIGURE 2: GXV3611IR_HD INSIDE VIEW	12
FIGURE 3: WINDOWS “NETWORK” SHOWING GXV3611IR_HD AS “OTHER DEVICES” VIA UPnP.....	15
FIGURE 4: “GS_SEARCH” RESULT PAGE OF GXV3611IR_HD	16
FIGURE 5-1: APPLE SAFARI “BONJOUR” SETTING PAGE TO DISPLAY GXV3611IR_HD	17
FIGURE 5-2: APPLE SAFARI “BONJOUR” SETTING PAGE TO DISPLAY GXV3611IR_HD	17
FIGURE 6-1: GXV3611IR_HD STANDALONE APPLICATION	20
FIGURE 6-2: GXV3611IR_HD WORKING IN LAN	21
FIGURE 6-3: GXV3611IR_HD WORKING WITH GVR3550 AND/OR GSURF_PRO WITH INTERNET	22
FIGURE 7-1: APPLICATION PERIPHERAL CONNECTION FOR GXV3611IR_HD.....	23
FIGURE 7-2: ALARM_IN AND ALARM_OUT CONNECTION CIRCUIT SAMPLE FOR GXV3611IR_HD	24
FIGURE 8: HOME PAGE OF GXV3611IR_HD	25
FIGURE 9: WEB LANGUAGE SWITCH	26
FIGURE 10: SYSTEM SETTINGS PAGE.....	27
FIGURE 11-1: VIDEO & AUDIO SETTINGS PAGE.....	28
FIGURE 11-2: VIDEO & AUDIO SETTINGS PAGE.....	29
FIGURE 12: OSD SETTINGS PAGE.....	30
FIGURE 13: CMOS SETTINGS PAGE.....	31
FIGURE 14: NETWORKING SETTING PAGE.....	32
FIGURE 15: DDNS SETTING PAGE.....	33
FIGURE 16-1: SIP SETTING PAGE.....	34
FIGURE 16-2: SIP SETTING PAGE.....	35
FIGURE 16-3: SIP SETTING PAGE.....	36
FIGURE 17: STATUS PAGE.....	37
FIGURE 18: USER MANAGEMENT PAGE	38
FIGURE 19: MAINTENANCE PAGE	39
FIGURE 20-1: SMTP SETTING PAGE.....	41
FIGURE 20-2: SMTP SETTING PAGE.....	42
FIGURE 21: FTP SETTING PAGE.....	42
FIGURE 22: PRIVACY MASKS CONFIGURATION PAGE.....	43
FIGURE 23: ALARM HTTP SERVER SETTING PAGE	44
FIGURE 24: TIME LAPSE PHOTOGRAPHY CONFIGURATION PAGE.....	45
FIGURE 25-1: ALARM_IN ACTION CONFIGURATION PAGE	46
FIGURE 25-2: ALARM EVENT TIME SCHEDULE CONFIGURATION PAGE.....	47
FIGURE 26-1: MOTION DETECTION CONFIGURATION PAGE.....	48
FIGURE 26-2: MOTION DETECTION SCHEDULE CONFIGURATION PAGE	49
FIGURE 27: SYSLOG SETTING PAGE.....	50
FIGURE 28: RECORD SETTING PAGE	51
FIGURE 29: LIVE STORAGE CONFIGURATION PAGE	52
FIGURE 30: FIRMWARE UPGRADE AND PROVISIONING	53
FIGURE 31: FACTORY RESET FROM WEB INTERFACE	55

TABLE OF TABLES
GXV3611IR_HD USER MANUAL

TABLE 1: GXV3611IR_HD TECHNICAL SPECIFICATIONS.....	13
---	----

WELCOME

Thank you for purchasing Grandstream's GXV3611IR_HD indoor infrared fixed dome high definition IP Camera, an innovative powerful day and night network camera.

GXV3611IR_HD is a next generation fixed dome day/night HD network camera of outstanding performance and quality. Its advanced ISP (Image Sensor Processor) powered with state-of-the-art auto-exposure/auto-white-balance algorithm and a high quality lens, ensures high fidelity video quality that matches digital still camera color grade in a wide range of light environments. It features cutting edge H.264 real-time video compression with excellent image clarity, industry leading SIP/VoIP for 2-way audio and video streaming to smartphones and videophones, integrated microphone, speaker, PoE, IR-CUT for day/night mode, edge storage and advanced security protection.



The GXV3611IR_HD can be managed with GSurf Pro (Grandstream's intuitive FREE video management software that controls up to 72 cameras simultaneously), or grouped with GVR3550 Grandstream Network Video Recorder (NVR) via plug-n-play, as well as other ONVIF compliant video management systems. It also offers an advanced and flexible HTTP API and an SDK for easy integration with other surveillance systems.

Designed for indoor environment with 2.8mm lens, the GXV3611IR_HD is ideal for wide angle monitoring of nearby subjects in environments such as banks, hotels, schools, retail stores and small warehouses, offices or building entrances, and other small to median sized enclosed environments.

The GXV3611IR_HD is a powerful network camera for advanced indoor surveillance applications.

SAFETY COMPLIANCES

These instructions are intended to assist users to safely operate the GXV3611IR_HD, avoid dangerous situations or damage the device.

	
<p>Warning: May cause serious injury or death if any of the warnings below are neglected.</p>	<p>Caution: Equipment may be damaged if any of the following caution messages are neglected.</p>



Warning:

Input voltage should meet both the SELV (Safety Extra Low Voltage) and the Limited Power Source with DC 12V according to the IEC60950-1 standard. Please refer to the technical specifications for more details. Do not use a third-party power adapter or power cord. When the device installed on the wall or ceiling, make sure that it is firmly attached.



Caution:

- Make sure that the power supply voltage is correct before using the camera.
- Do not drop the device or expose it to physical shock.
- Do not expose the device to temperatures outside the range of 0 °C to 45°C when the device is in operation.
- Do not expose the device to damp/wet conditions or high electromagnetism radiation.
- To avoid heat accumulation, make sure that your operating environment has proper ventilation.
- Do not damage the warranty sticker.

A few parts (e.g. electrolytic capacitor) of the equipment shall be replaced regularly according to their average lifetime. The average lifetime varies from the differences between operating environments and usage history. Regular maintenance checks are recommended for all users. Please contact your dealer for more details.

FCC CAUTION

Any Changes or modifications not expressly approved by the party responsible for compliance could void the user's authority to operate the equipment. This device complies with part 15 of the FCC Rules. Operation is subject to the following two conditions:

- 1) This device may not cause harmful interference.
- 2) This device must accept any interference received, including interference that may cause undesired operation.

Note: This equipment has been tested and found to comply with the limits for a Class B digital device, pursuant to part 15 of the FCC Rules.

These limits are designed to provide reasonable protection against harmful interference in a residential installation. This equipment generates uses and can radiate radio frequency energy and, if not installed and used in accordance with the instructions, may cause harmful interference to radio communications. However, there is no guarantee that interference will not occur in a particular installation. If this equipment does cause harmful interference to radio or television reception, which can be determined by turning the equipment off and on, the user is encouraged to try to correct the interference by one or more of the following measures:

- Reorient or relocate the receiving antenna.
- Increase the separation between the equipment and receiver.
- Connect the equipment into an outlet on a circuit different from that to which the receiver is connected.
- Consult the dealer or an experienced radio/TV technician for help.

RF EXPOSURE INFORMATION (SAR)

This device is designed and manufactured not to be exceeded the emission limits for exposure to radio frequency RF energy set by the Federal Communications Commission of the United States. The exposure standard for wireless devices employing a unit of measurement is known as the Specific Absorption Rate (SAR), and the SAR limit set by FCC is 1.6 W/kg.

This device is complied with SAR for general population/uncontrolled exposure limits in ANSI/IEEE C95.1-1992, and has been tested in accordance with the measurement methods and procedures specified in OET Bulletin 65 Supplement C. This device has been tested, and meets the FCC RF exposure guidelines when tested with the device directly contacted to the body. RF exposure compliance with anybody-worn accessory, which contains metal, was not tested and certified, and uses such body-worn accessory, should be avoided.

Changes or modifications not expressly approved by the party responsible for compliance could void the user's authority to operate the equipment.

Hereby, Grandstream declares that this device is in compliance with the essential requirements and other relevant provisions of Directive 1999/5/EC.

WARRANTY

If the GXV3611IR_HD was purchased from a reseller, please contact the company where the device was purchased for replacement, repair or refund.

If the device was purchased directly from Grandstream, please contact our technical support team for a RMA (Return Materials Authorization) number before the product is returned.

Grandstream reserves the right to remedy warranty policy without prior notification.



Caution:

Changes or modifications to this product not expressly approved by Grandstream, or operation of this product in any way other than as detailed by this User Manual, could void your manufacturer warranty. Please do not use a different power adaptor with the GXV3611IR_HD because this may cause damage to the products and void the manufacturer warranty.

- This document is subject to change without notice. The latest electronic version of this user manual is available for download at:

http://www.grandstream.com/products/surveillance/gxv3611ir/documents/gxv3611ir_hd_um.pdf

Reproduction or transmittal of the entire or any part, in any form or by any means, electronic or print, for any purpose is not permitted without the express written permission of Grandstream Networks, Inc.

CONNECT YOUR GXV3611IR_HD

Equipment Package Contents

The GXV3611IR_HD package contains:

- GXV3611IR_HD IP Camera
- 12V DC Universal Power Adaptor
- 1 Drill Template
- Quick Installation Guide
- GPL License

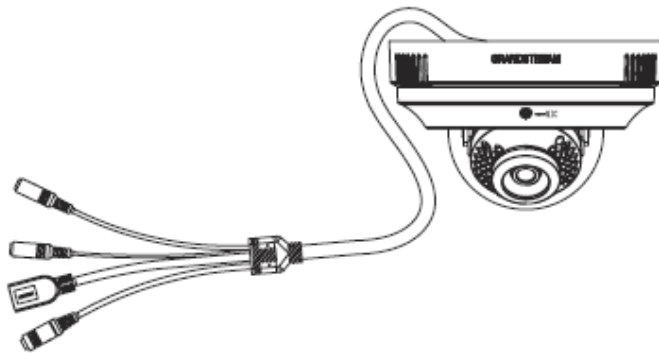

1 x GXV3611IR_HD



1 x 12V Power Supply

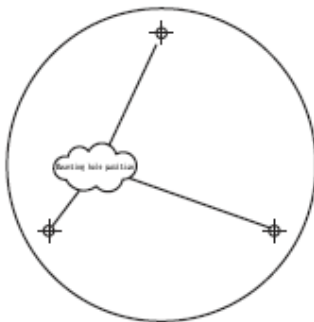

1 x Drill Template

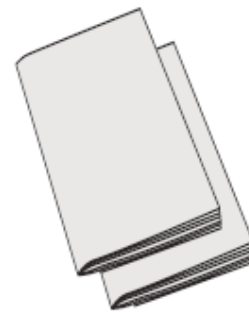

1 x Quick Start Guide
1 x GPL License

Connecting the GXV3611IR_HD

Using the Power Adapter as power supply

- Connect the RJ45 Ethernet cable to the NETWORK port of the GXV3611IR_HD
- Connect the other end of the RJ45 cable to your network (switch or router or PC)
- Connect the power supply to the DC 12V power jack on the back of the GXV3611IR_HD

Using PoE as power supply

- Connect the RJ45 Ethernet cable to the NETWORK port of GXV3611IR_HD
- Connect the other end of the RJ45 cable to your PoE switch
- PoE injector can be used if PoE switch is not available.

Please refer to following connection diagram to hook up the camera.

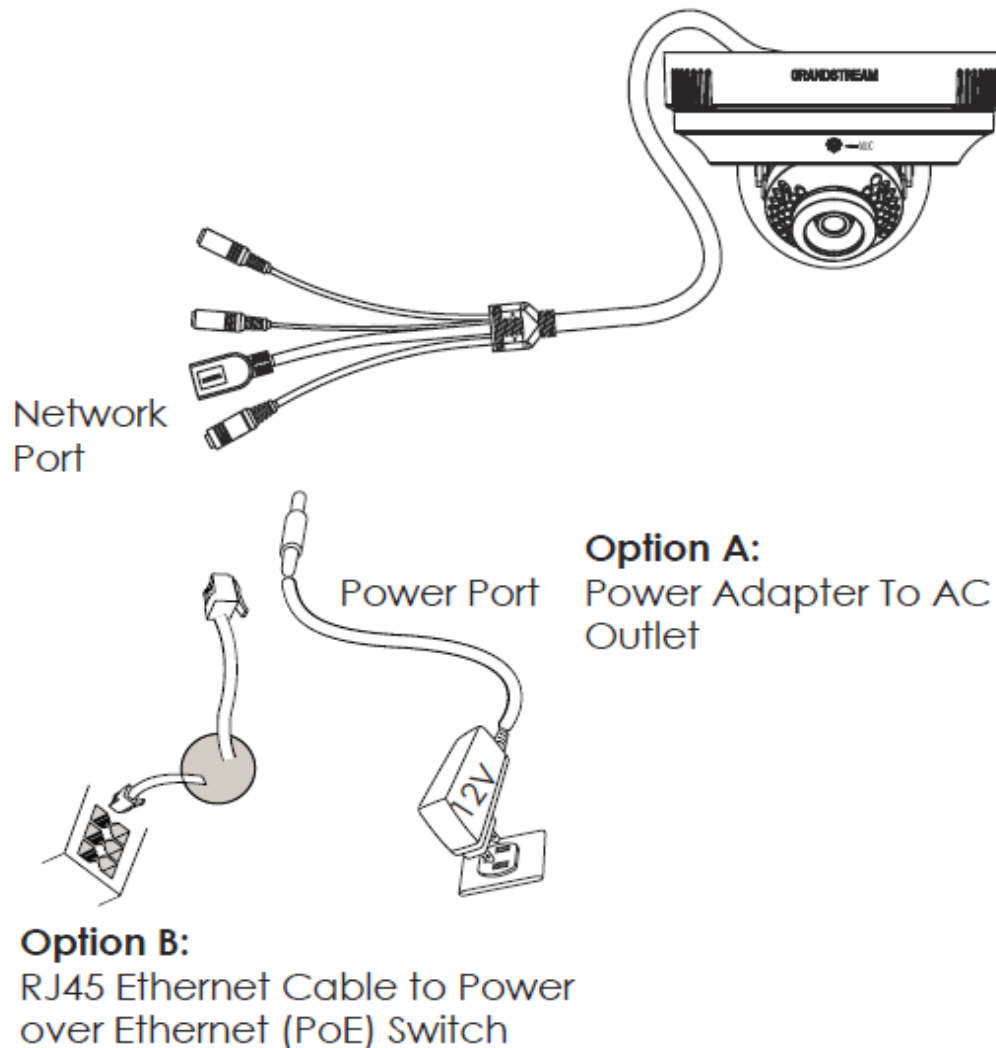

NOTE: Choose Option A if using the power supply; or choose Option B if using a Power over Ethernet (PoE) switch.

PRODUCT OVERVIEW

GXV3611IR_HD Camera

Please see below the diagram and explanation of GXV3611IR_HD IP camera:

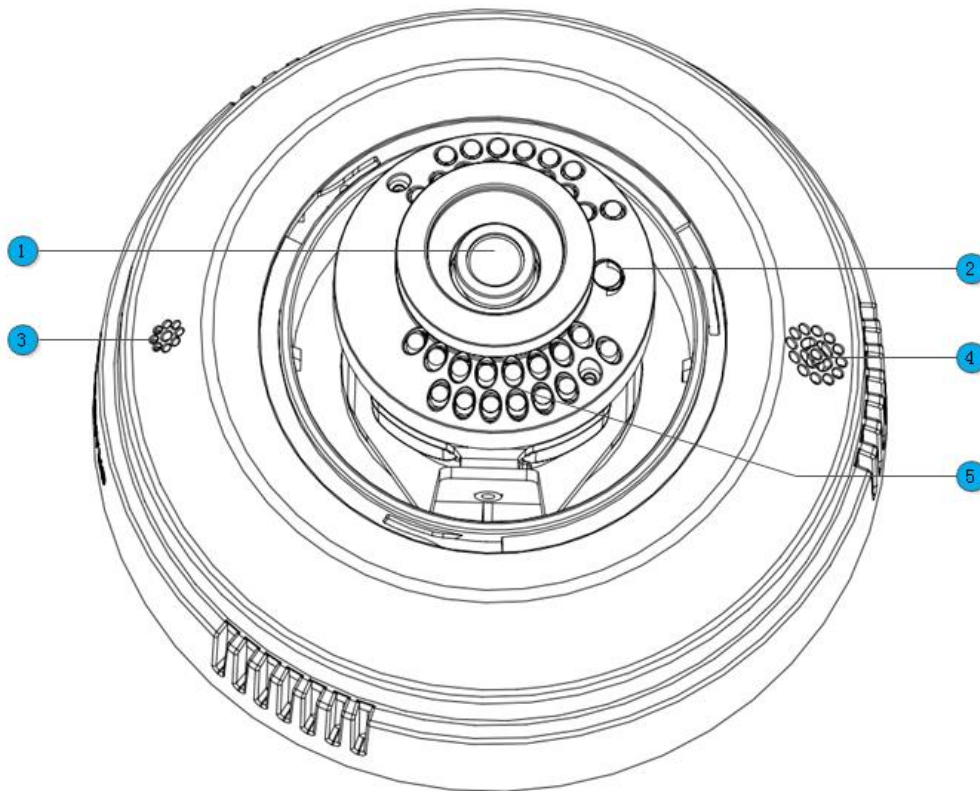

Figure 1: GXV3611IR_HD Outside View

- | | |
|-----------------------------------|--|
| 1. <i>Lens</i> | GXV3611IR_HD Lens (2.8mm) |
| 2. <i>Light Sensor for IR-Cut</i> | Light Sensor for mechanical IR-Cut switching |
| 3. <i>Microphone</i> | Built-in Microphone |
| 4. <i>Speaker</i> | Built-in Speaker |
| 5. <i>IR LED Light Array</i> | Infrared Light Array |



Caution:

Avoid scratch or contaminate the surface of transparent ball cover, which may cause IR reflection at night to deteriorate image quality.

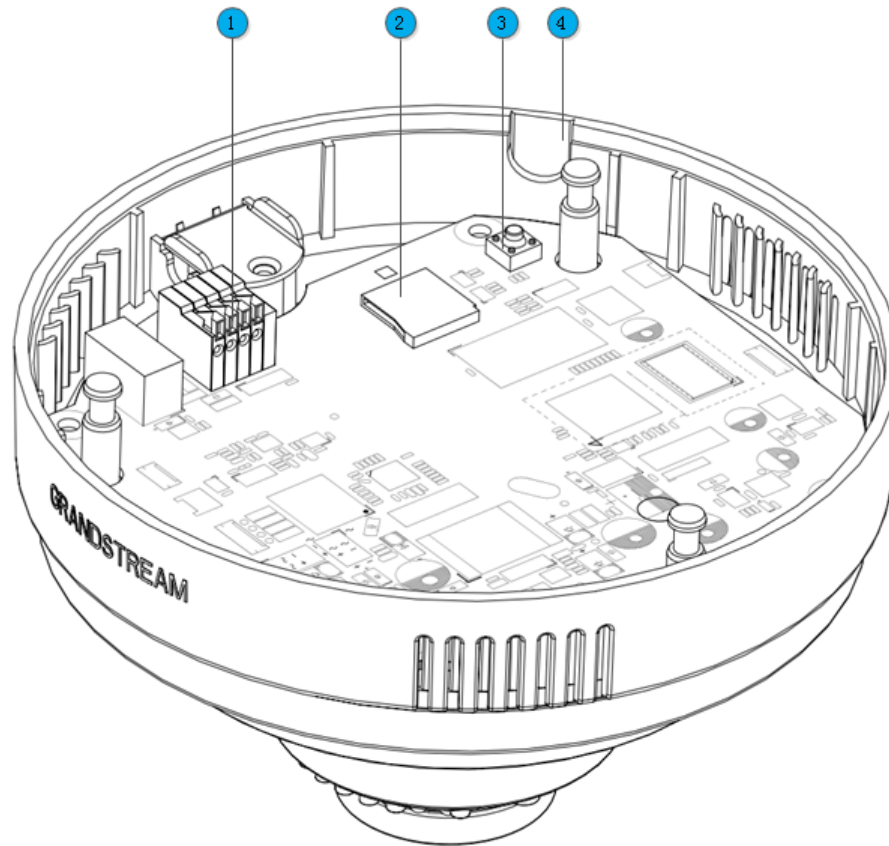

Figure 2: GXV3611IR_HD Inside View

- | | |
|---|---|
| <ol style="list-style-type: none"> 1. Alarm Interface 2. MicroSDHC Slot 3. Reset Button 4. Side Wiring Knockout | <p>PIN Interface for Alarm_In and Alarm_Out</p> <p>MicroSD card slot (max. 32GB card, not provided)</p> <p>Factory Reset Button</p> <p>Side knockout opening for wiring</p> |
|---|---|

NOTE:

- For side wiring installation, please remove side wiring knockout using appropriate tools/cutters, sanding and smoothing the opening to avoid sharp edge cutting the cable.
- To insert the microSD card, taken out the camera body from mounted top cover, gently pushing in the microSD card until a click sound heard.
- To remove the microSD card, pushing further the card until a click sound heard, hold the card then quickly release the holding force, the spring inside the card slot will push out the microSD card automatically.
- Push inward the **orange color** Pin Clippers to connect the Alarm_In or Alarm_Out wiring. Recommended using CAT3 and above wiring cable.
- To “hard” factory reset the camera, with the camera powered on, press and hold the “reset” button for 15 seconds until the IP camera reboot. The internal small **red** power LED will illustrate “On → Off → On”, meaning a successful hard factory reset.

GXV3611IR_HD Specifications

Model	GXV3611IR_HD v2
Video Compression	H.264, MJPEG
Image Sensor Resolution	Megapixel Progressive Scan CMOS, 1280H x 720V
Image Sensor Sensitivity	Day/Night mode, exceptionally low noise, low light levels Shutter: 1/10000 – 1/30 second
Focal Length	2.8mm
Aperture	F1.8
IR Cut Filter	Yes, Mechanical
Day & Night Mode	IR LED with full software control
Minimum Illumination	0 Lux
Pan	176°
Tilt	70°
Sensitivity	3300mV / (lux-sec)
Supported Maximum Video Resolution and Frame Rate	1280x720 (30fps)
Video Bit Rate	32 Kbps ~ 8 Mbps, Multi-rate for Preview & Recording
Audio Input	Built-in Microphone; 3.5mm Line-In (1.5KΩ)
Audio Output	Built-in Speaker; 3.5mm Line-Out (600Ω, 0.707 Vrms)
Alarm Input	Yes, Vin < 15V, PINs
Alarm Output	Yes, 125VAC/0.5A, 30VDC/2A, Normal Open, PINs
Integrated Microphone	Yes
Integrated Speaker	Yes
SIP/VoIP Support	Yes
Privacy Mask Support	Yes, 4 Zones
Smart IR Support	Yes (Optimal White Balance and Exposures)
Time-Lapse Recording	Yes
Micro SDHC Card	Yes (up to 32GB)
Snapshots	Triggered upon Events, Send via email and/or FTP
Audio Compression	G.711u/A (PCMU, PCMA)
Embedded Analytics	Motion Detection (up to 16 target areas)
Pre-/post-alarm Recording	Yes
Power over Ethernet (PoE)	IEEE 802.3af Class 2; 10M/100M Auto-sensing, 2KV Lightning Surge Protection
Network Protocol	TCP/UDP/IP, RTP/RTCP, RTSP, DHCP, DDNS, HTTP, HTTPS, SMTP, FTP, NTP
Cable Connections	<i>External:</i> RJ45 Ethernet 3.5mm Line-In 3.5mm Line-Out Power Input (12VDC/0.5A) <i>Internal:</i> PINs for Alarm-In & Alarm-Out
Dimensions (D x H)	138mm (D) x 93mm (H)
Weight	0.4kg
Temperature / Humidity	Operating: 0°C ~ +45°C (32°F ~ 113°F), 10 – 90% RH (Non-condensing) Storage: -20°C ~ +60°C (-4°F ~ 140°F)
Power Adapter	Output: 12VDC/0.5A; Input: 100–240VAC, 50–60Hz
Casing	Plastic Case for Indoor Only
Compliance	FCC Part 15, Subpart B Class B; EN 55022 Class B, EN 61000-3-2, EN 61000-3-3, EN 55024, EN 60950-1; RCM AS/NZS CISPR 22/24, AS/NZS 60950

Table 1: GXV3611IR_HD Technical Specifications

INSTALLATION GUIDE

Minimum Recommended Computer System Requirement

To install GXV3611IR_HD, you have to have a computer, PC recommend.
The minimum recommended PC system requirement listed below:

- Windows XP, Windows Vista, Windows 7 and Windows 8
- CPU: Intel Pentium 4 or higher, 2 GHz
- RAM: 2 GB (4 GB recommended for larger systems)
- Support for DirectX 8.0 and above.

Configure the GXV3611IR_HD via Web Browser

The GXV3611IR_HD has embedded Web server to respond to HTTP GET/POST requests. Embedded HTML pages allow user to configure the IP camera through Microsoft Internet Explorer (7.0 or above), Firefox, Chrome (plug-in from Grandstream required).

- Download WebControl Plug-in from Grandstream website:
http://www.grandstream.com/products/tools/surveillance/webcontrol_plugin.zip

For Apple platform OS-X, only MJPEG video coded supported currently.

NOTE:

- *Please temporarily disable Antivirus or Internet Security Software when download and install the Grandstream WebControl Plug-in for Firefox/Chrome or "GSViewerX.cab" for Microsoft Internet Explorer. Please close Browser to install the downloaded Plug-in or Active-X.*
- *Please trust and install the file downloaded if prompted by the Antivirus or Security software.*

Connect the Camera to network with DHCP server (Recommended)

The GXV3611IR_HD by default enabled as DHCP client, it will automatically get IP address from the network with DHCP server running.

WINDOWS PLATFORM:

There are two ways for Windows user to get access to the IP Camera easily:

A. UPnP

By default, the GXV3611IR_HD has the UPnP feature turned ON. For customers using Window network with UPnP turned on (most SOHO router support UPnP), it is very easy to access the IP camera:

- Find the “Network” icon  at Windows Desktop.
- Click the icon to get into the “Network” and the IP cameras will list as “Other Devices” shown like below. Refresh the pages if nothing displayed. Otherwise, the UPnP may not active in the network.

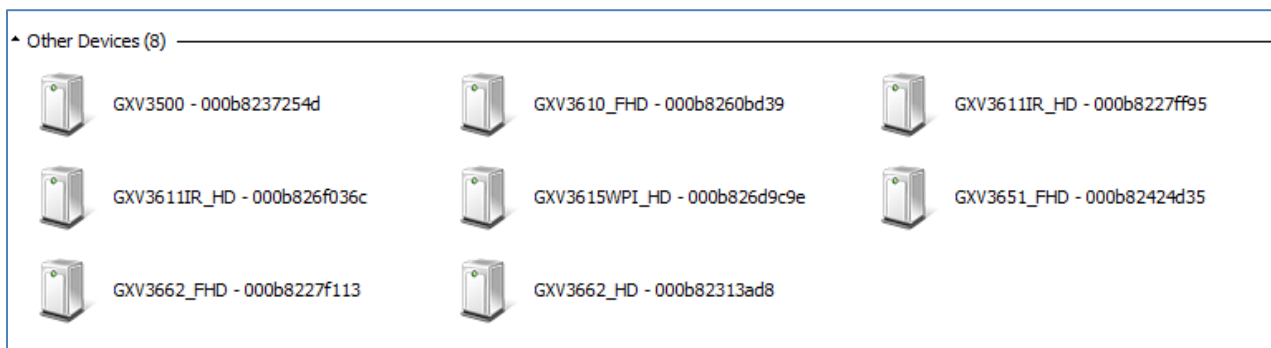
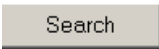

Figure 3: Windows “Network” showing GXV3611IR_HD as “Other Devices” via UPnP

- Click the displayed icon of related IP camera, the default browser (e.g.: Firefox or Chrome) will open and connect directly to the camera’s webpage, prompt message will display asking for plug-in installation.
- Disable security or antivirus software, download the plug-in, close browser and install the plug-in, open the browser again, the embedded video will be displayed if clicking the icon of the related IP Camera.

B. “GS Search” Utility Tool

User can know the IP address assigned to the camera from DHCP server log or using the Grandstream GS_Search tool. Following is the instruction for using “GS_Search” utility tool:

1. Download the GS_Search tool from Grandstream website:
http://www.grandstream.com/products/tools/surveillance/GS_Search.zip
2. Run the Grandstream GS_Search tool by double click the unzipped “GS_Search.exe”.
3. Click on the  button to begin device detection
4. The detected devices will appear in the output field like below

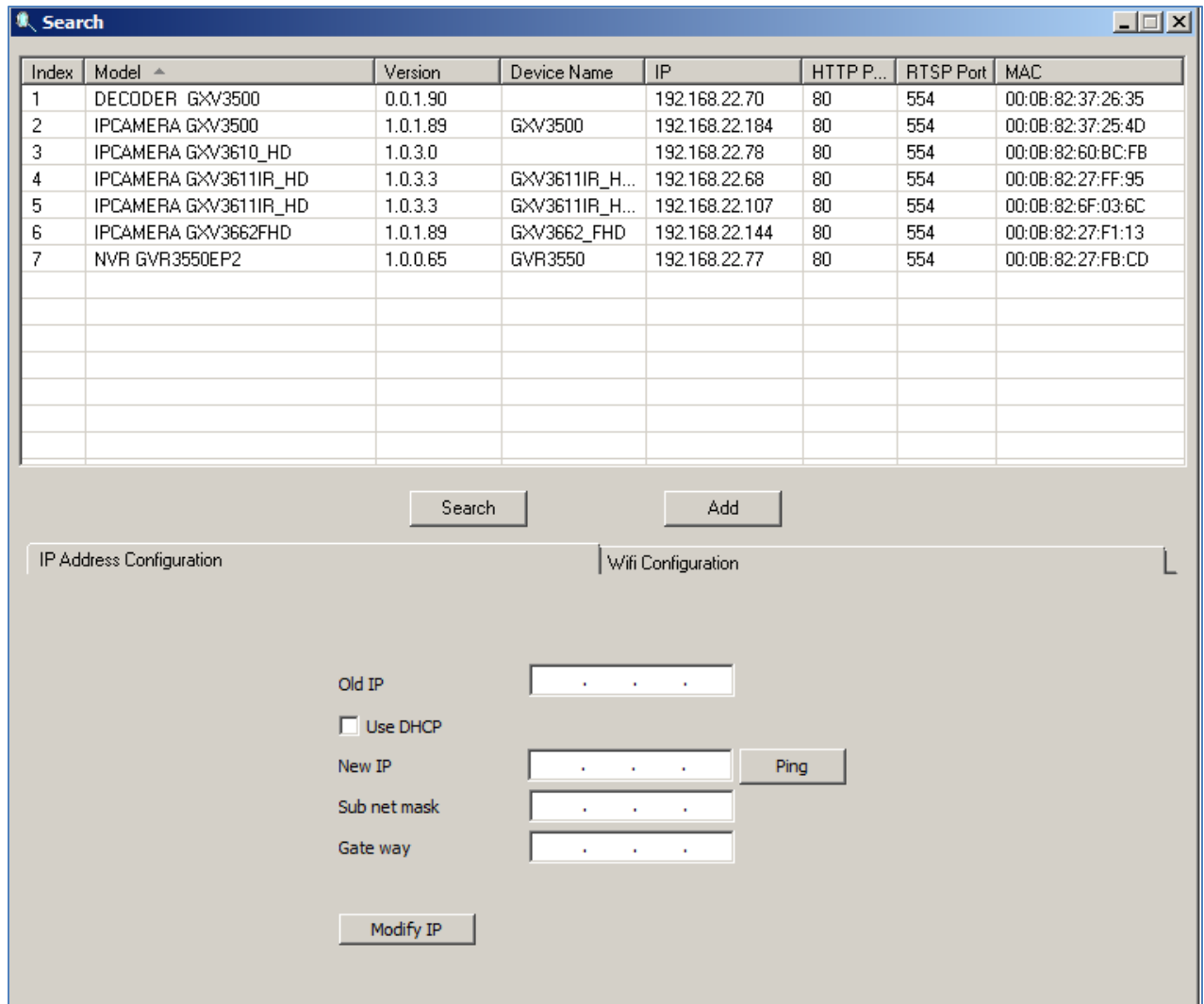

The screenshot shows a window titled "Search" with a table of detected devices. Below the table are buttons for "Search" and "Add". At the bottom, there are two tabs: "IP Address Configuration" (selected) and "Wifi Configuration". The IP configuration form includes fields for "Old IP", "New IP", "Sub net mask", and "Gate way", along with a "Use DHCP" checkbox, a "Ping" button, and a "Modify IP" button.

Index	Model	Version	Device Name	IP	HTTP P...	RTSP Port	MAC
1	DECODER GXV3500	0.0.1.90		192.168.22.70	80	554	00:0B:82:37:26:35
2	IPCAMERA GXV3500	1.0.1.89	GXV3500	192.168.22.184	80	554	00:0B:82:37:25:4D
3	IPCAMERA GXV3610_HD	1.0.3.0		192.168.22.78	80	554	00:0B:82:60:BC:FB
4	IPCAMERA GXV3611IR_HD	1.0.3.3	GXV3611IR_H...	192.168.22.68	80	554	00:0B:82:27:FF:95
5	IPCAMERA GXV3611IR_HD	1.0.3.3	GXV3611IR_H...	192.168.22.107	80	554	00:0B:82:6F:03:6C
6	IPCAMERA GXV3662FHD	1.0.1.89	GXV3662_FHD	192.168.22.144	80	554	00:0B:82:27:F1:13
7	NVR GVR3550EP2	1.0.0.65	GVR3550	192.168.22.77	80	554	00:0B:82:27:FB:CD

Figure 4: “GS_Search” Result Page of GXV3611IR_HD

5. Double click the column of the detected camera, the browser will automatically open and link to the device IP and the web configuration page.
6. The browser will ask for plug-in or ActiveX if not installed, otherwise it will get to Home page and start to show the video captured by the camera (by default the camera enabled anonymous access)
7. Click “Configuration” icon, the browser will ask credentials to authorize configuration.
8. Enter the administrator user name and password to access the Web Configuration Interface, the default user name and password are both set to **admin**.
9. In step 6, browser will indicate that “This website wants to install the following add-on: GSViewerX.cab from Grandstream Networks Inc.” Please allow the installation.
10. The plug-in can be download here:

http://www.grandstream.com/products/tools/surveillance/webcontrl_plugin.zip

APPLE PLATFORM:

For Apple users, please turn on Bonjour of Safari to find and access the GXV3611IR_HD.

- 1) Open Safari, select “Advanced” to open the Advanced Setting.
- 2) Click “Include Bonjour in the Bookmarks menu” and “Include Bonjour in the Favorites bar” then close the setting page and back to Safari.

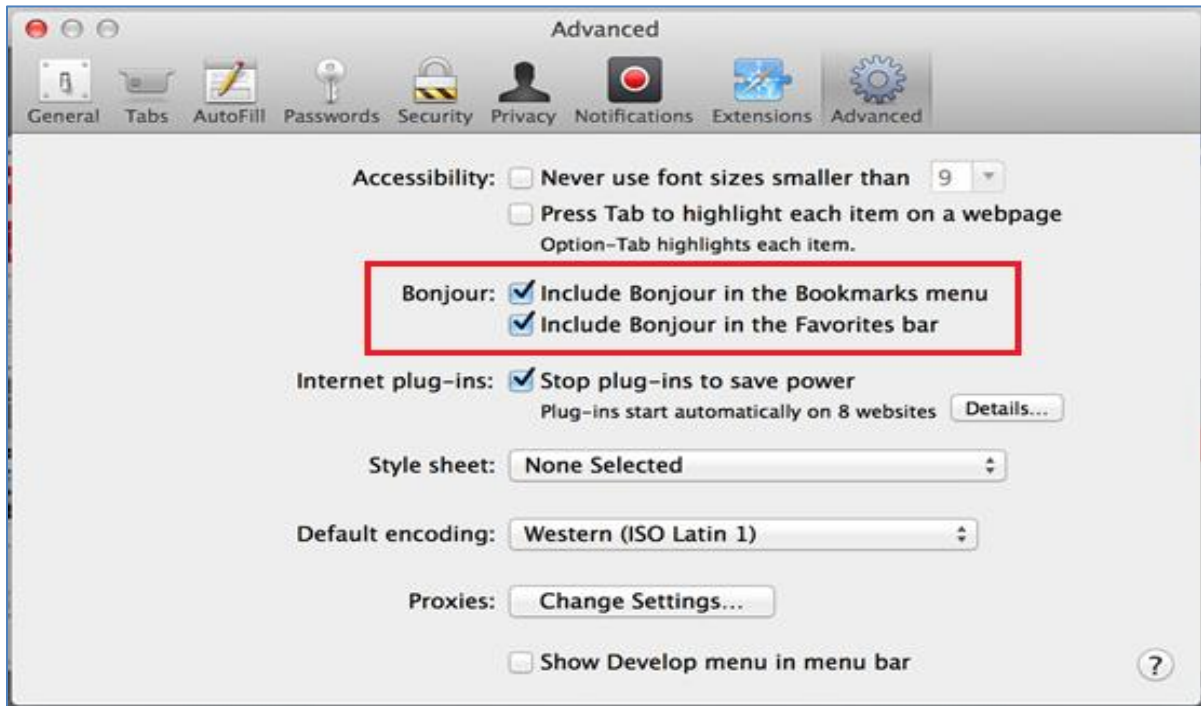

Figure 5-1: Apple Safari “Bonjour” Setting page to display GXV3611IR_HD

- 3) Bonjour will now display embedded at Safari. Select “Bonjour” pull-down menu and select “Webpages”, the related IP Camera like GXV3611IR_HD will be there.



Figure 5-2: Apple Safari “Bonjour” Setting page to display GXV3611IR_HD

- 4) Click the displayed camera to access to the configuration page of the camera.

- 5) To see the video, user has to change the video codec from default H.264 to MJPEG, and type in following to URL:

http://IP_Address_Camera:Port/mjpeg/mjpegX.html

(X: 0, 4 represent 1st, 2nd stream, Default Port: 80)



NOTE:

- *The instruction given here based on Safari/OS-X, other Apple platform like iOS (iPhone/iPad) can use similar method.*



- *iPhone/iPad (iOS) users are recommended to use Applications in Apple Store.*
- *Free or Paid applications from Apple Store like “IP Cam Viewer” are suggested and verified working with Grandstream IP Cameras like GXV3611IR_HD.*
- *Apple Store applications like “IP Cam Viewer” will support H.264 video codec.*

Connect to the Camera using Static IP

If no DHCP server in the network, or the camera does not get IP from DHCP server, user can connect the camera to a computer directly, using static IP to configure the camera.

The default IP, if no DHCP server; or DHCP offer time out (3 minutes), is **192.168.1.168**

1. Connect the computer network port via an Ethernet cable directly to the IP camera GXV3611IR_HD.
2. Configure the computer using Static IP: 192.168.1.XXX (1<XXX<255, but NOT 168) and configure the “Subnet mask” to “255.255.255.0”. Leave the “Default Gateway” to “Blank” like below: (Example of Windows platform, Apple platform is similar)

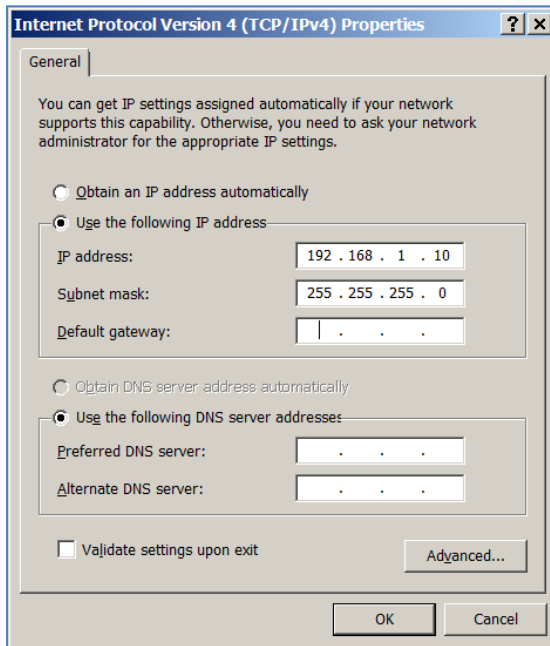

3. Power on the GXV3611IR_HD.
4. Start the browser when the network connection is up.
5. Enter 192.168.1.168 in the address bar of the browser.
6. The browser will ask for plug-in or ActiveX if not installed, otherwise it will get to Home page and start to show the video captured by the camera (by default the camera enabled anonymous access)
7. Click “Configuration” icon, the browser will ask credentials to authorize configuration.
8. Enter the administrator user name and password to access the Web Configuration Interface, the default user name and password are both set to **admin**.
9. In step 6, IE will indicate that “This website wants to install the following add-on: GSViewerX.cab from Grandstream Networks Inc.”, allow the installation.
10. Firefox, Chrome user need to download and install the plug-in to see the video, the plug-in is here: http://www.grandstream.com/products/tools/surveillance/webcontrl_plugin.zip

NOTE:

- *Please temporarily disable Antivirus or Internet Security Software and close all browsers when download and install the Grandstream Plug-in Software.*

GXV3611IR_HD APPLICATION SCENARIOS

GXV3611IR_HD is a very versatile indoor infrared IP Camera, it can be used in a lot of scenarios.

Battery Power or No network

For environment like remote warehouse/storage, grocery store, small (take-out) restaurants, just plug in a 32GB microSD card, the GXV3611IR_HD will meet your very basic surveillance requirement

This is idea solution to upgrade the traditional standalone CCTV security system, while leave the potential of operating it in IP network when the network is available. All you need is power (could be battery) and SD card, network wiring is not necessary required and can leave to future upgrade when it available.

Product	Power Adapter Model			POE Model			Class Advertisement (IEEE802.3af)
	Standby	Operating	Max Power	Standby	Operating	Max Power	
	Power(W)	Power(W)	Power(W)	Power(W)	Power(W)	Power(W)	
GXV3611IR_HD	1.34	3.27	3.87	1.95	3.91	4.51	2

Equipment List:

- 1) GXV3611IR_HD
- 2) 32GB microSDHC card
- 3) Ethernet cable and PoE injector (Optional)

Depending on the space monitored, one or several GXV3611IR_HD may be required.

NOTE:

- 32GB SD card can hold about 5 day 7x24 video recording using 720p 10fps 2M video bit rate.
- For more days of storage, please use Motion Detection triggered SD card Video Recording.

A small remote warehouse with GXV3611IR_HD installed monitoring inside.

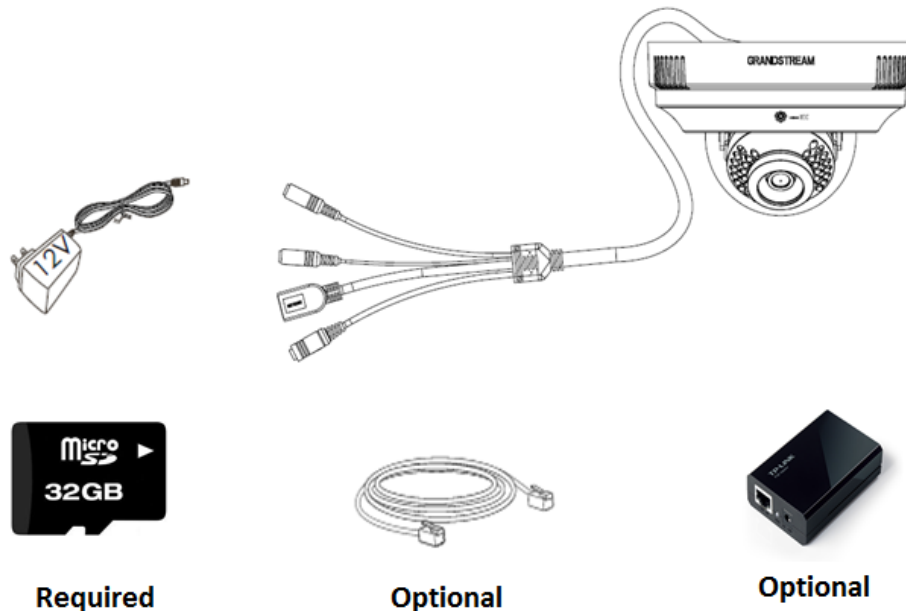

Figure 6-1: GXV3611IR_HD Standalone Application

LAN w/o Internet

For multi-room or a bigger space, multiple GXV3611IR_HD might be required. User can establish a local area network using PoE switch.

If remote access required, a router with internet access may add in.

Equipment List:

- 1) Several GXV3611IR_HD
- 2) Several 32GB microSDHC cards (each IP camera with one SD card)
- 3) Ethernet cables
- 4) Switch (Static IP required to configure to IP Cameras)
- 5) PoE Switch (Optional, better solution)

If remote access to the cameras required to view the LIVE video stream, then broadband Internet is required and more equipment required:

- 6) Router (if DHCP configured than static IP is not required although still recommended)
- 7) Broadband Internet Access (FiOS, Cable or DSL)
- 8) iPhone or Android phone.

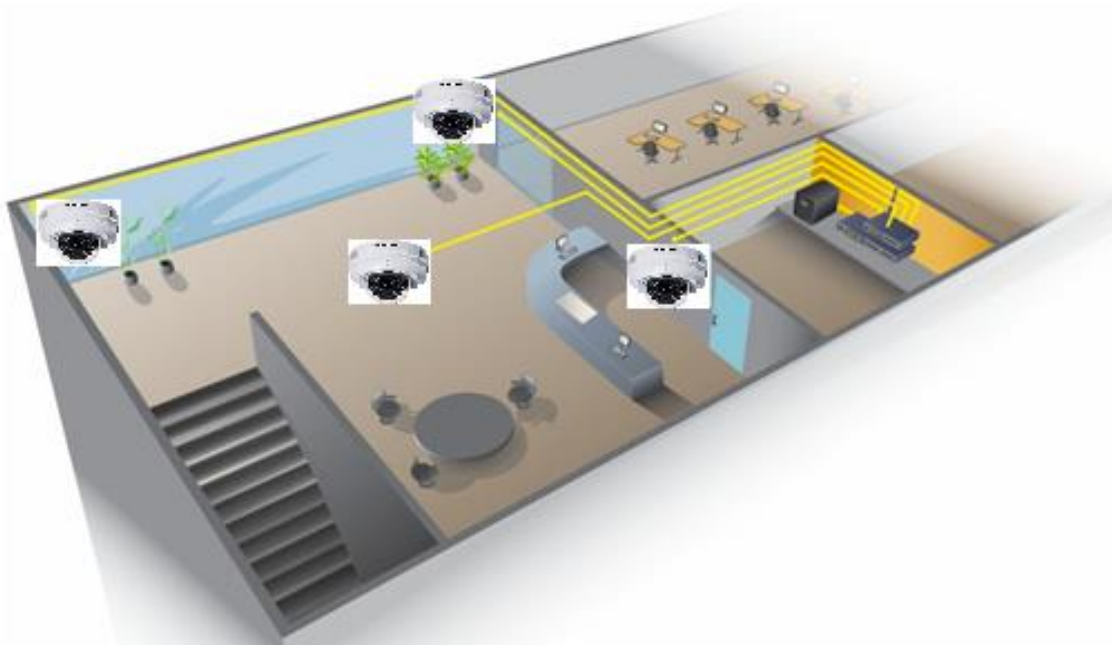

Figure 6-2: GXV3611IR_HD Working in LAN

LAN with Internet

For multi-room or a bigger space, with Internet access and local video recording required, following list is recommended:

Equipment List:

- 1) Several GXV3611IR_HD
- 2) GVR3550 NVR
- 3) Ethernet cables
- 4) Switch (PoE Switch recommended)
- 5) Router
- 6) Broadband Internet Access (FiOS, Cable or DSL)
- 7) iPhone or Android phone
- 8) GSurf_Pro Remote Access (Optional)

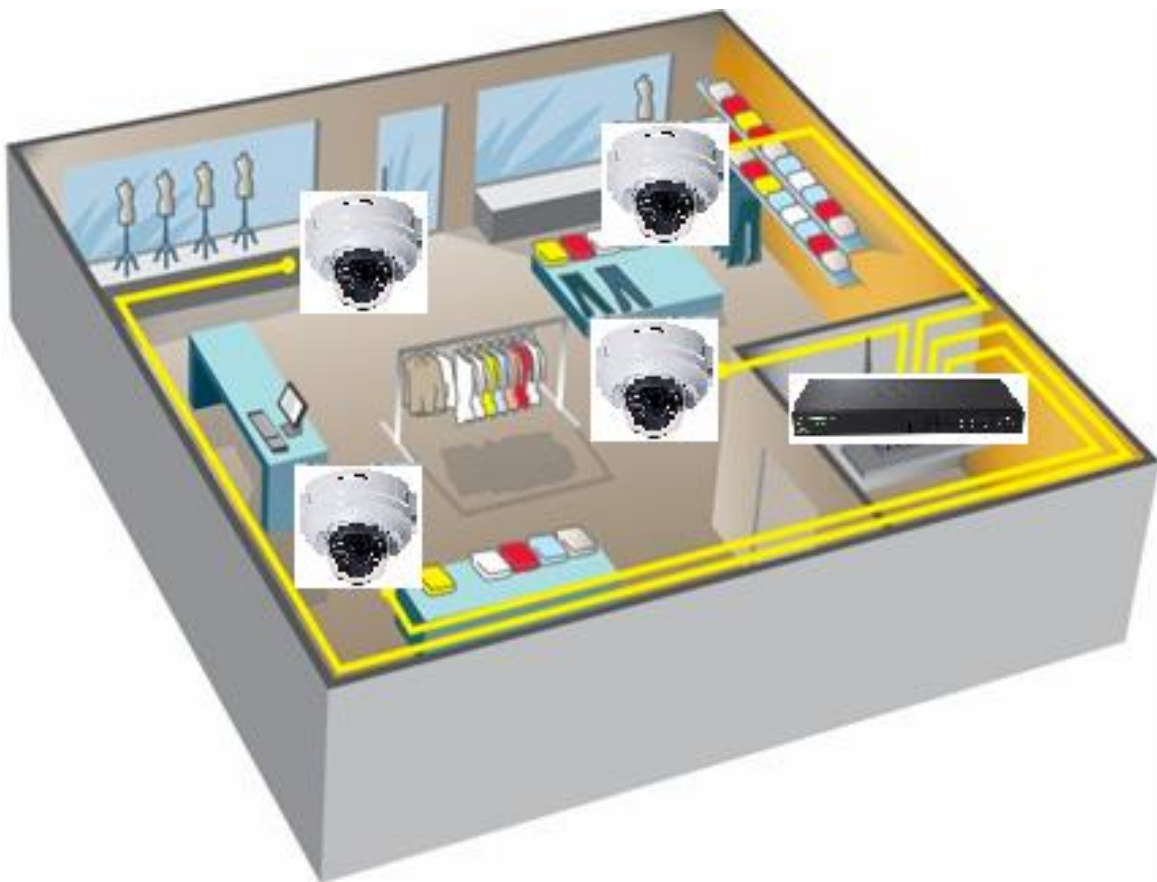

Figure 6-3: GXV3611IR_HD Working with GVR3550 and/or GSurf_Pro with Internet

GXV3611IR_HD Application Peripheral Connection

Below is the illustration of GXV3611IR_HD peripheral connections for related application.

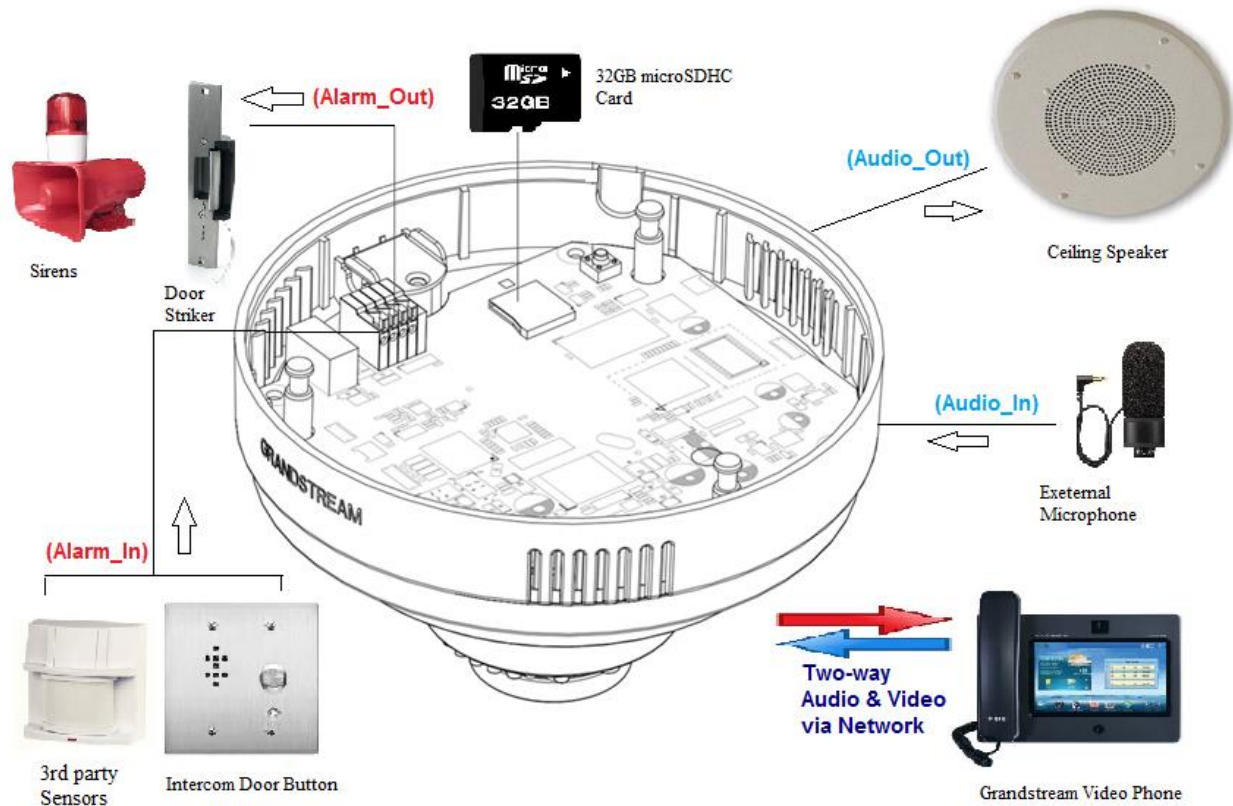

Figure 7-1: Application Peripheral Connection for GXV3611IR_HD

NOTE:

- 32GB SD card can hold about 5 day 7x24 video recording using 720p 10fps 2M video bit rate. For more days of storage, either using Motion Detection Event Video Recording, or using Grandstream GVR3550, or GSurf_Pro VMS.
- Alarm_In could use any 3rd party Sensors (like IR Motion Sensor) or Intercom Push Button, etc.
- Alarm_Out device could use 3rd party Siren and Strobe Light, or Electric Door Striker, etc.
- Audio Input (Microphone) and Audio Output (Amplified Speaker) using 3.5mm interface and must match below impedance parameter:

Audio Input	3.5mm Line-In (1.5KΩ)
Audio Output	3.5mm Line-Out (600Ω, 0.707 Vrms)

- Grandstream Video Phone can work with GXV3611IR_HD via either Peer IP (LAN) or SIP extension (WAN). Peer to Peer (or Direct IP) works only at LAN using static IP; SIP extension requires related SIP server/proxy provided and configured.

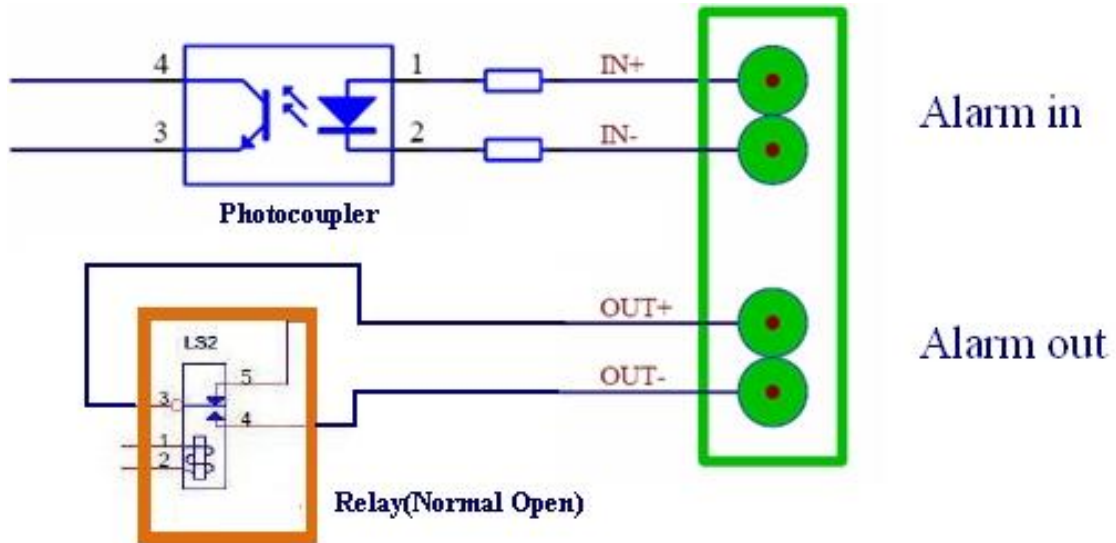

Figure 7-2: Alarm_In and Alarm_Out Connection Circuit Sample for GXV3611IR_HD

NOTE:

- The Alarm_In and Alarm_Out circuit connection has to be similar to above circuit diagram and meet following requirement:

Alarm Input	Vin<15V, PINs (1.02KΩ)
Alarm Output	125VAC/0.5A, 30VDC/2A, Normal Open, PINs

- The Alarm_In circuit (like above photo coupler), if there is any voltage change smaller than 15V, as specification listed), the GXV3611IR_HD Alarm_In port will detect it and trigger the action and event.
- Higher voltage and wrong polarity connection are prohibited because this will damage the devices.

GXV3611IR_HD HOME WEB PAGE

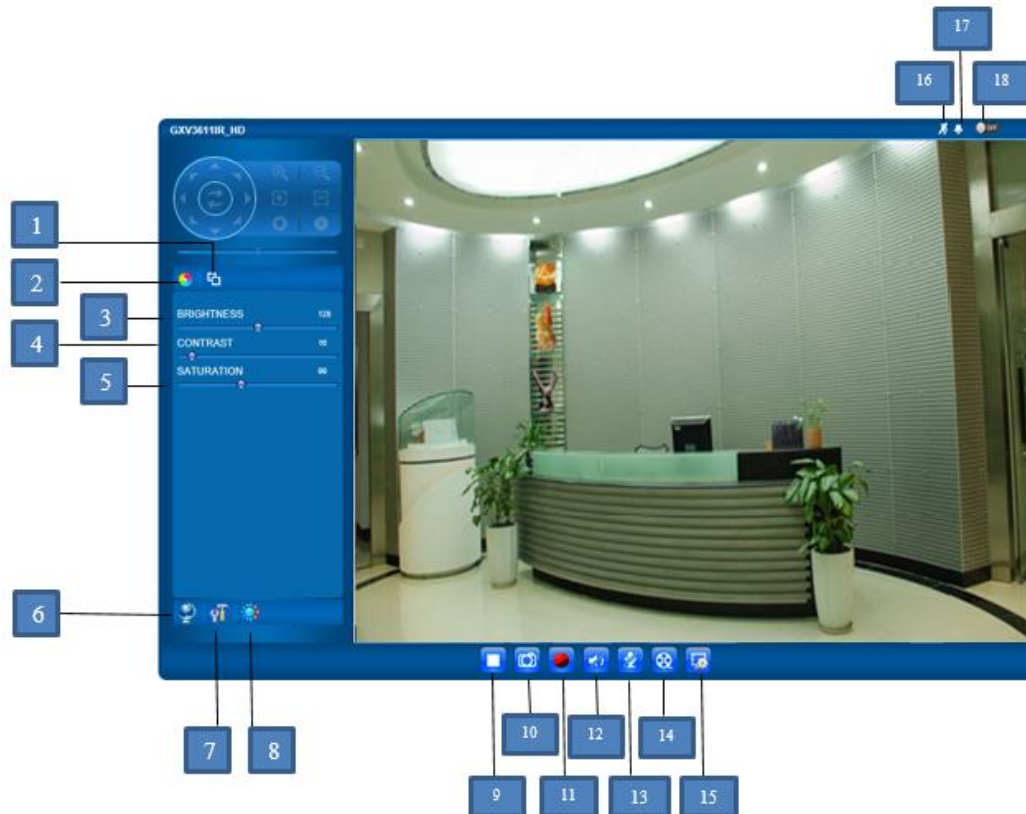

Figure 8: Home Page of GXV3611IR_HD

- | | |
|--|--|
| <ol style="list-style-type: none"> 1. Real Size/Window Size icon: 2. ZOOM: 3. BRIGHTNESS bar: 4. CONTRAST bar: 5. SATURATION bar: 6. Language icon 7. Configuration icon: 8. Default Video Parameter icon: 9. Stop/Play Video icon: 10. Capture (Snapshot) icon 11. Record icon: 12. Listen On/Off icon: 13. Talk On/Off icon: 14. Playback: 15. Local Configuration: 16. Motion Detection Alarm Indicator: 17. DI, Alarm_In icon: 18. DO, Alarm_Out icon: | <p>Click to switch between real resolution size and embedded window size video.</p> <p>Zoom in or Zoom out during ePTZ operation (Not Applicable).</p> <p>Adjust the image or video brightness.</p> <p>Adjust the image or video contrast.</p> <p>Adjust the image or video saturation.</p> <p>Click to switch webpage language.
(Current support: Chinese, English and Russian)</p> <p>Click to enter "Configuration Page" to configure the parameters of GXV3611IR_HD (Administration privilege required).</p> <p>Click to reset video parameters (Brightness, Contrast, Saturation) to default.</p> <p>Click to Stop and Play the embedded live video.</p> <p>Click to capture and save a snapshot of current displayed video frame.
Default directory: C:\Capture, using date stamp as folder name.</p> <p>Click to Start/Stop record of current video stream into a file.
Default directory: C:\Record</p> <p>Toggle to listen/stop audio from the camera's microphone</p> <p>Toggle to talk to camera's speaker (computer microphone required)</p> <p>Click to playback the recorded video file.</p> <p>Click to configure the file path of snapshot and recorded video files.
Also adjust the video delay or smoothness.</p> <p>If (configured) motion detection alarm triggered, the indicator will flash in red.
Click the indicator icon to turn off the alarm indication.</p> <p>The indicator will be on when there is an external Alarm Input.
Click the indicator icon to turn off the alarm indication.</p> <p>Click the indicator icon manually switch the Alarm_Out operation.</p> |
|--|--|

GXV3611IR_HD Configuration & Language Page

- When click the “Configuration” icon, web page will link to page to configure the related parameters of the GXV3611IR_HD.
- There are two big categories of settings: **Basic Settings** and **Advanced Settings**. Details will illustrate in the following Chapters.
- When click the “Language” icon, supported languages will display in Figure 2. Click to select the related webpage display language.

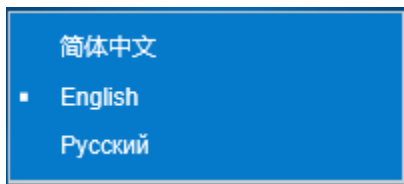

Figure 9: Web Language Switch

- Currently firmware only support: English (default), Simplified Chinese and Russian.

BASIC SETTINGS EXPLANATION

System Settings Page

This page allow user to configure the system settings of GXV3611IR_HD.

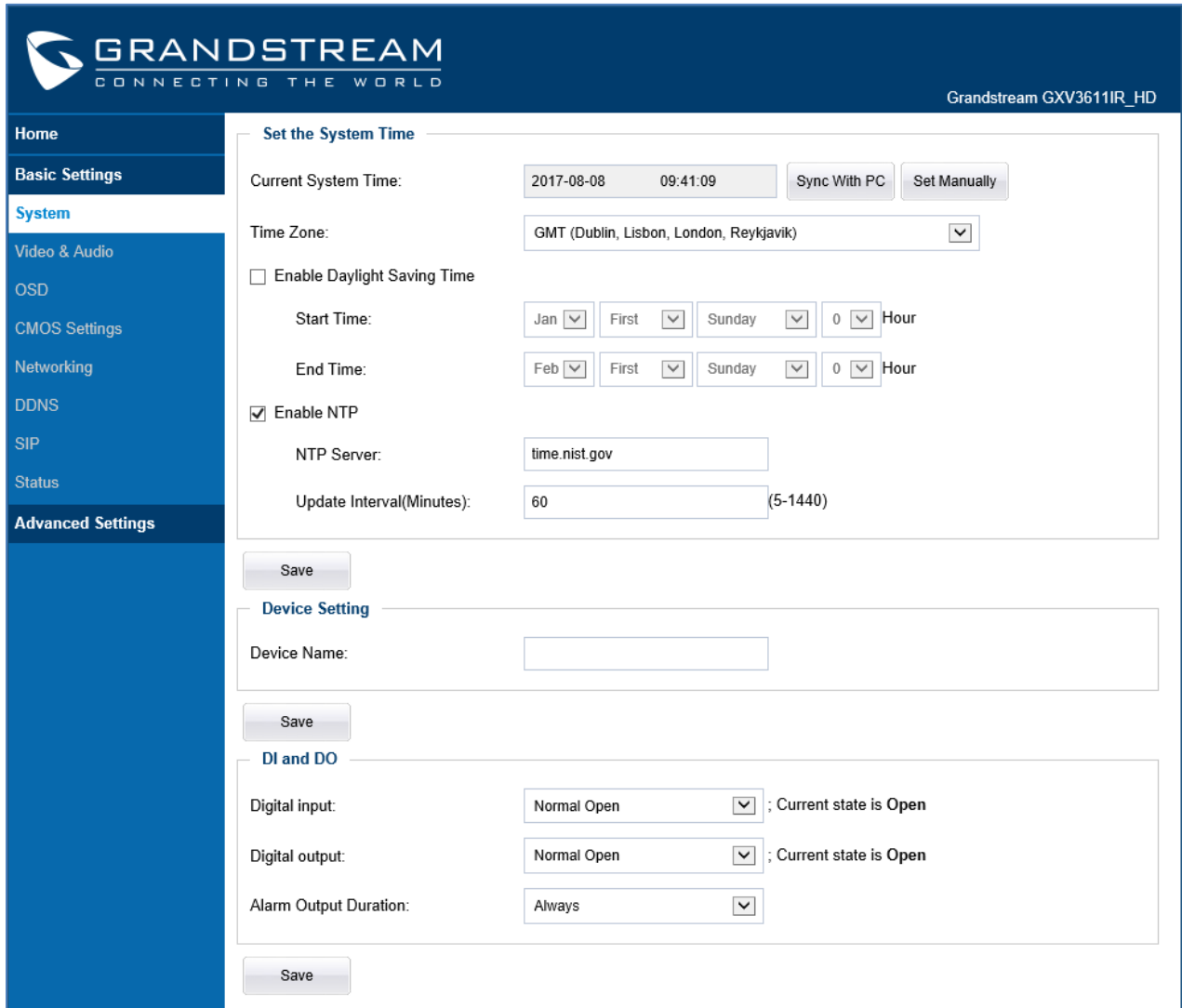

GRANDSTREAM
CONNECTING THE WORLD

Grandstream GXV3611IR_HD

Home

Basic Settings

System

Video & Audio

OSD

CMOS Settings

Networking

DDNS

SIP

Status

Advanced Settings

Set the System Time

Current System Time: 2017-08-08 09:41:09 Sync With PC Set Manually

Time Zone: GMT (Dublin, Lisbon, London, Reykjavik)

Enable Daylight Saving Time

Start Time: Jan First Sunday 0 Hour

End Time: Feb First Sunday 0 Hour

Enable NTP

NTP Server: time.nist.gov

Update Interval(Minutes): 60 (5-1440)

Save

Device Setting

Device Name:

Save

DI and DO

Digital input: Normal Open ; Current state is Open

Digital output: Normal Open ; Current state is Open

Alarm Output Duration: Always

Save

Figure 10: System Settings Page

- **Current System Time:**
 - **Sync with PC:** Display time current system is running at Click to synchronize current time with computer.
 - **Set Manually:** Click to manually set the current time and date.
- **Time Zone:** Select from pull down menu the time zone unit located
 - **Enable DST:** Configure Day Light Saving Time
 - **NTP:** Enable and configure NTP server and update interval.
- **Device Name:** Set the name of the camera which will be shown in the result of “Search Tool” of GSurf_Pro VMS program.
- **DI and DO:** DI and DO initial status for Alarm In or Out operation.
 - **DO Duration:** Select operation of Alarm Output Duration from pull down list.

Video & Audio Setting Page

This page allows user to configure the video and audio related settings.

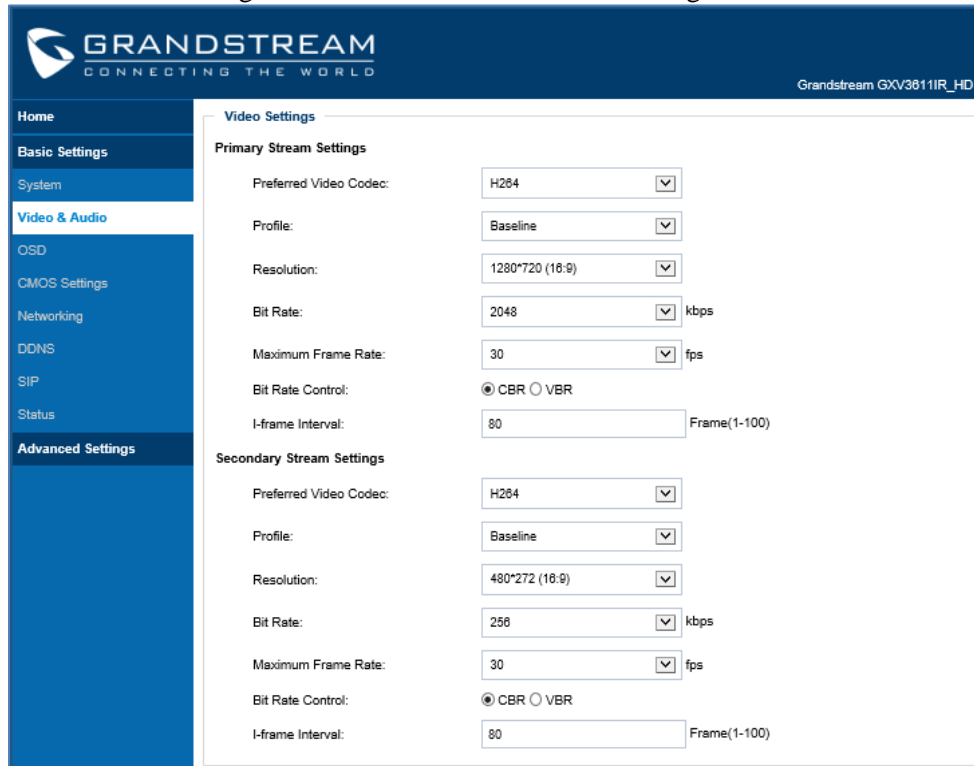

Figure 11-1: Video & Audio Settings Page

Video Settings

- **Primary Stream Settings:**
 - Preferred Video Codec: MJPEG and H.264 supported, H.264 recommended.
 - Profile: H.264 profile selection. Default is “Main Profile.”
 - Resolution: The resolution in pixels used at video image
 - Bit Rate: video bit rate or bandwidth used
 - Maximum Frame Rate: Maximum frame rate used (more data if big frame used)
 - Bit Rate Control: Constantly bit rate, or variable bit rate
 - Image Quality: Image quality used when Variable Bit Rate used
 - I-frame Interval: I-frame interval (suggested 2~3 times of frame rate)

- **Secondary Stream Settings:** Same as primary stream.

NOTE:

- H.264 suggested if camera needs to be viewed via Internet.
- The definition of Baseline, Main Profile and High profile of H.264 please refer to: http://en.wikipedia.org/wiki/H.264/MPEG-4_AVC
- If MJPEG selected, reduce max. frame rate to min. value to save bandwidth and get better image

- Grandstream IP Camera provides two video streams, user can use them with flexibility. For example, the high-resolution stream for local recording; another low or high resolution for remote monitoring; or vice versa depending application scenarios.
- *Use below link to calculate bandwidth and storage before installation*
<http://www.grandstream.com/support/tools/bandwidth-storage-calc>

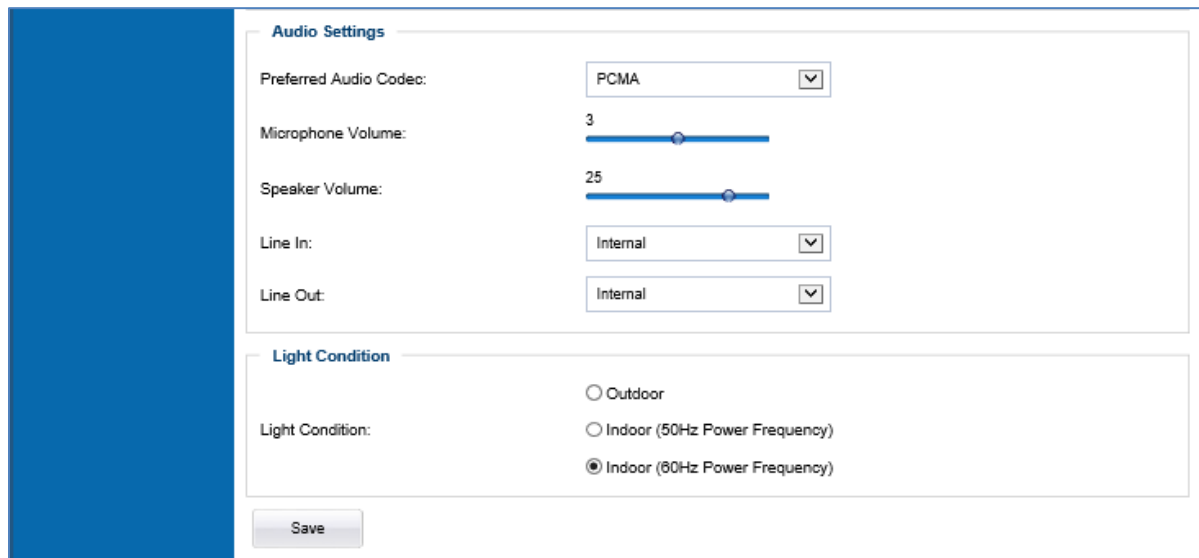

Figure 11-2: Video & Audio Settings Page

- **Audio Settings:**
 - Preferred Audio Codec: PCMU, PCMA supported. Audio also can be disabled.
 - Microphone Volume: Slide to adjust microphone gain.
 - Speaker Volume: Slide to adjust the speaker volume connected.
 - Line In: Select Internal (microphone) or External audio input path.
 - Line Out: Select Internal (speaker) or External audio output path.

- **Light Condition:** Select correct light condition for the scene monitored: Outdoor, Indoor 50Hz power frequency (Europe, China, etc.) or 60Hz power frequency (US, Japan, etc.). Wrong setting will affect image quality under fluorescence light condition.

OSD Setting Page

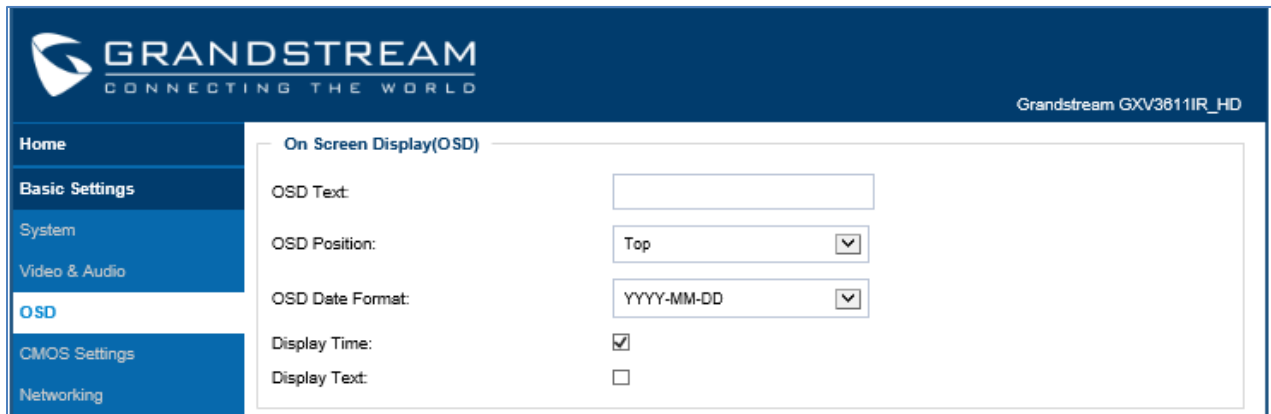

Figure 12: OSD Settings Page

- ***On Screen Display (OSD):***
 - OSD Text: Display time stamp and text on the video screen.
 - OSD Position: Inputted text (to identify the camera) shown on the screen.
 - OSD Date Format: Show the OSD in either top or bottom position on screen.
 - Display Time: OSD Date format, choose based on user preference.
 - Display Text: When checked, time will be displayed inside the video image
 - Display Text: When checked, inputted text will display on video image

CMOS Settings Page

This page allows user to adjust the CMOS parameters:

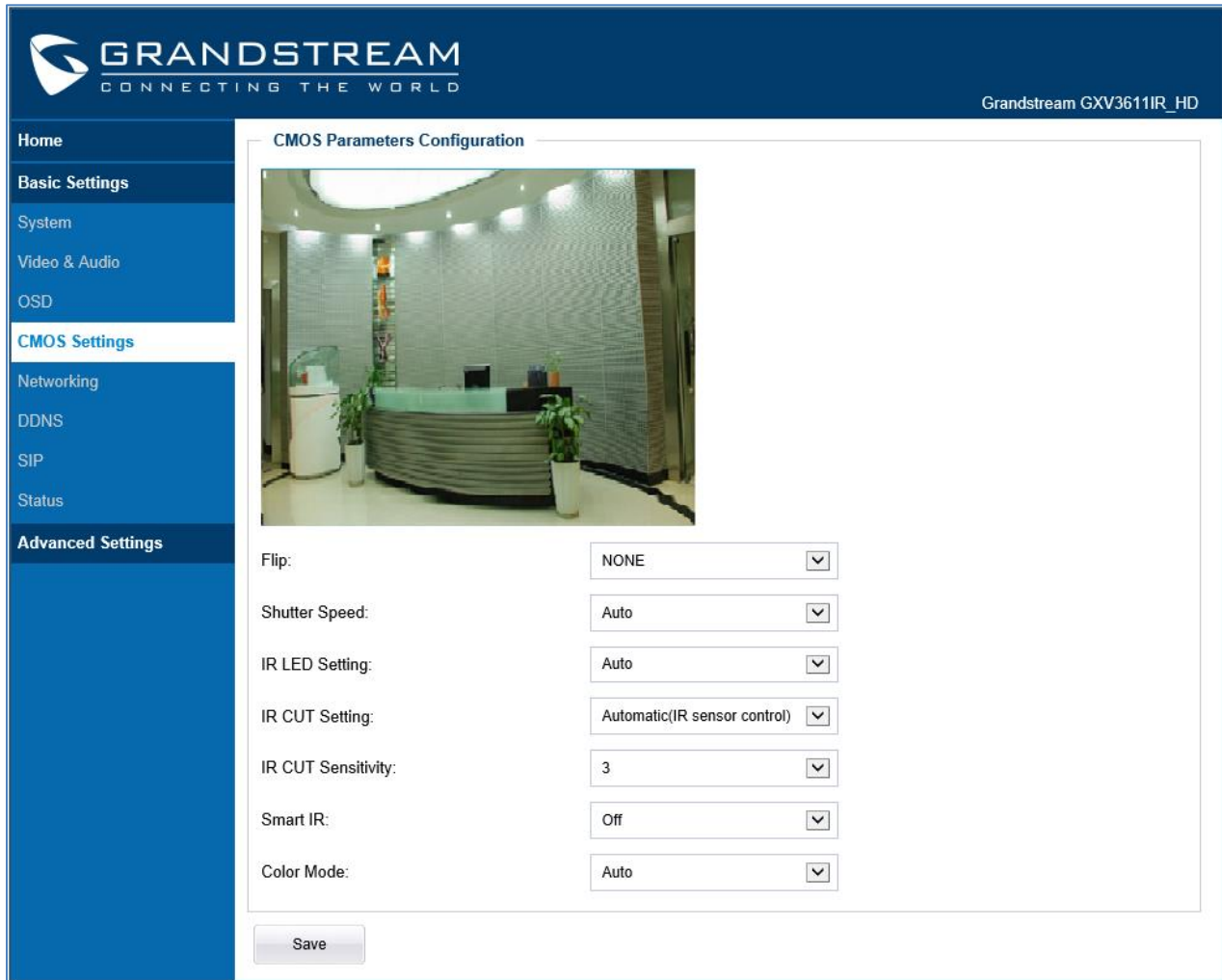

Figure 13: CMOS Settings Page

- **Flip:** Pull down to choose video flip, either vertically or horizontal or both.
- **Shutter Speed:** Camera Shutter Speed. There are 10 options, with Auto, 1/30 (slowest), 1/60, 1/125, 1/250, 1/500, 1/1000, 1/2000, 1/5000 and 1/10000 (fastest)
- **IR LED Setting:** Auto, or manually turn ON or turn OFF the LED light. Default Auto
Manually On/Off LED light applied to save power if camera powered by battery.
- **IR CUT Setting:** Manual, Automatic (IR Sensor control) or Time Schedule Mode (configurable Daytime Schedule for user's flexibility) to switch the mechanical IR_CUT.
- **IR CUT Sensitivity:** Sensitivity of IR Sensor to trigger the IR CUT; 5 levels total and 5 highest sensitivity.
- **Color Mode:** Camera Color Mode. There are three options: Color, Black/White, Auto (Default).

NOTE:

- **Auto** option recommended for Shutter Speed, IR LED Setting, IR CUT Setting and Color Mode.

Networking Setting Page

This page allows user to configure network related parameters:

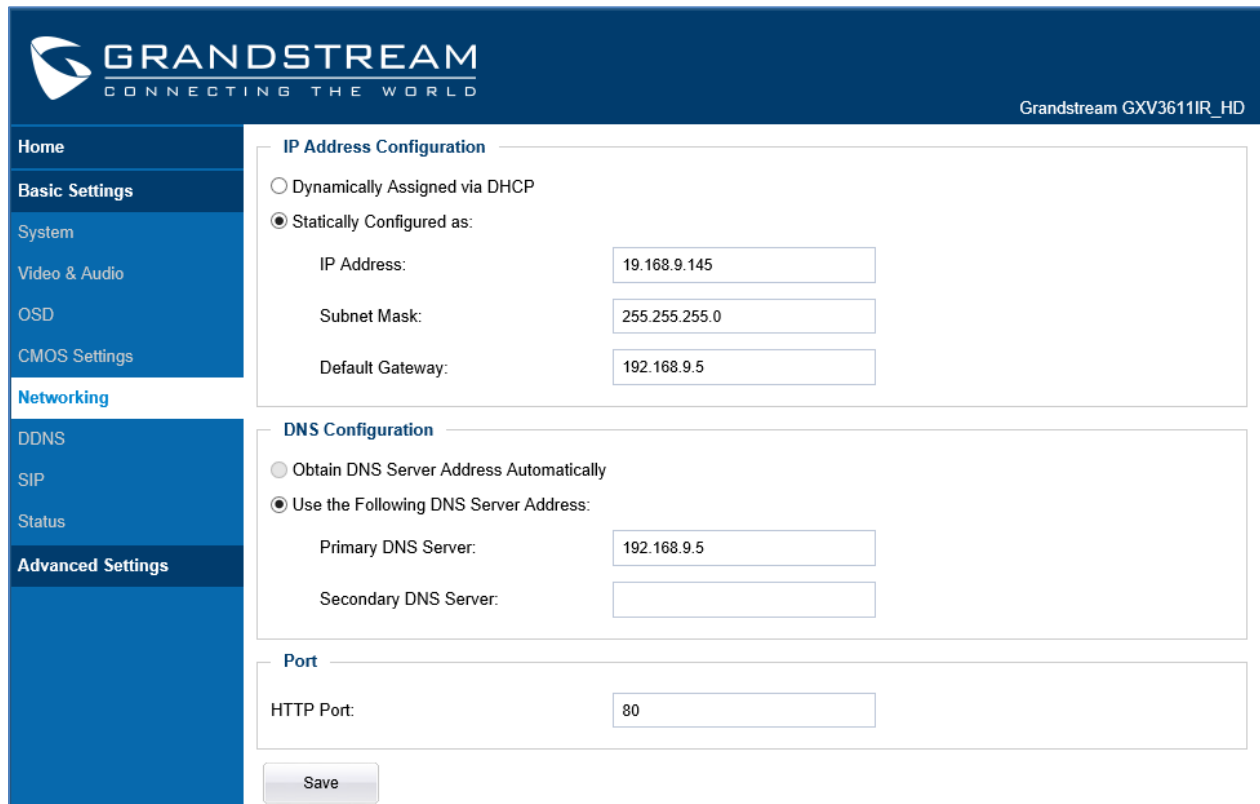

Figure 14: Networking Setting Page

- **IP Address Configuration:**
 - Dynamically Assigned via DHCP: Camera IP address configuration. Default setting, DHCP server assign IP to camera.
 - Statically Configured as: Static IP address configuration (Preferred for Port FWD)
- **DNS Configuration:** DNS server IP. Must be configured if using static IP.
- **HTTP:** Web access TCP port, default 80.

NOTE:

- *If camera behind SOHO router with port forwarding configuration for remote access, static IP or static DHCP has to be used to avoid IP address change after router reboot.*
- *TCP port above 5000 suggested if Port Forward HTTP for remote access, due to some ISP would block port 80 for inbound traffic. For example, change the default HTTP port from 80 to 8088, to make sure the TCP port not likely blocked.*
- *In addition to HTTP port, RTSP port is also required to configure via port forward, so remote party can view the video stream.*
- *If revise the default TCP port 80 to port "A", then RTSP port should be "2000+A" (changed from default TCP 554). Both TCP port "A" and "2000+A" should be configured for port forwarding in the router. For example, the HTTP port changed to 8088, the RTSP port now should be 10088, both TCP ports 8088 and 10088 should be configured for port forwarding in order for remote camera access: 8088 for web portal, 10088 for video streaming.*

DDNS Settings Page

This page allows user to configure dynamic DNS related parameters:

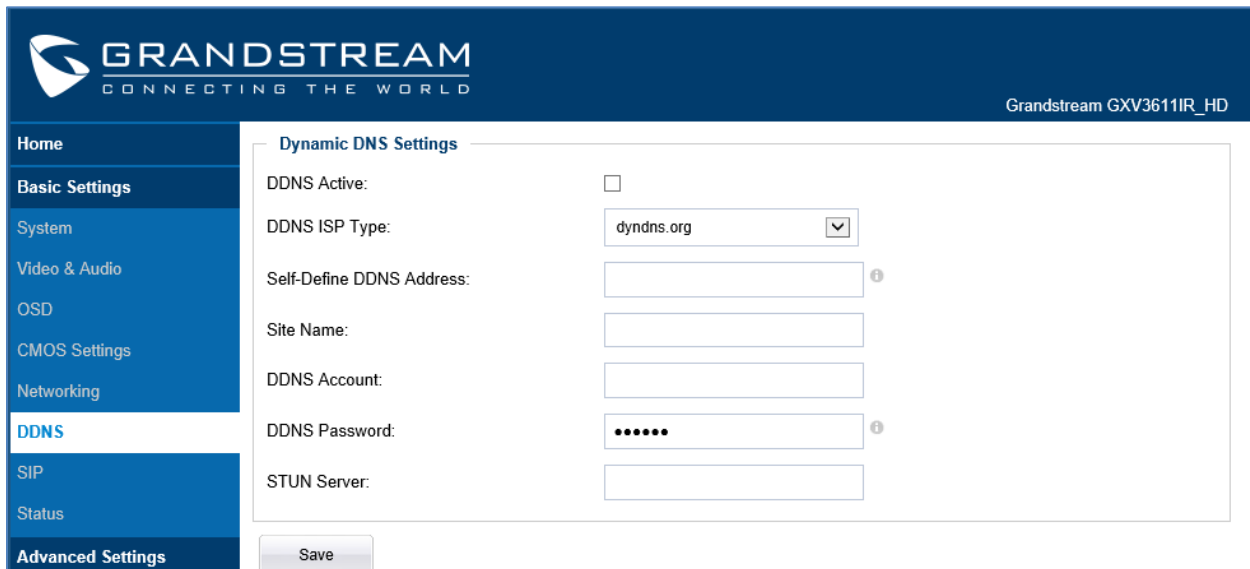

Figure 15: DDNS Setting Page

- **DDNS Active:** Enable DDNS by check this field.
- **DDNS ISP Type:** Select the DDNS service provider from the pull-down menu list
- **Self-Define DDNS Address:** Input the self-defined DDNS address
- **Site Name:** DDNS site name
- **DDNS Account:** DDNS account name
- **DDNS Password:** DDNS password
- **STUN Server:** Stun server FQDN or IP. If device behind a non-symmetric router, STUN server can help to penetrate & resolve NAT issue.

SIP Setting Page

GXV3611IR_HD can be configured as SIP endpoint to call out when alarm triggered, or allow permitted number to call in to check the audio/video if Grandstream IP videophone used.

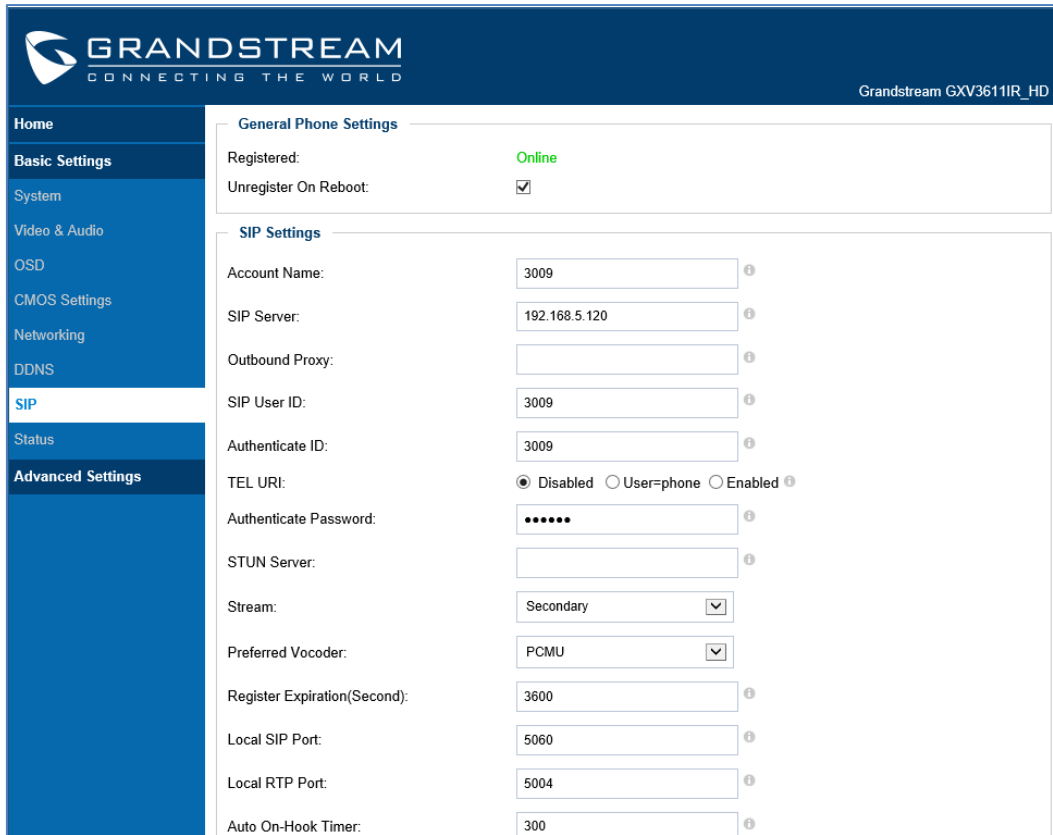



Figure 16-1: SIP Setting Page

- **Registered:** SIP registration status. Display “Online” in Green, “Offline” in Red.
- **Unregistered on Reboot:** If checked and SIP server support, reboot camera will unbind all registered end points using this SIP account.
- **Account Name:** SIP account name used for self identification.
- **SIP Server:** FQDN or IP of SIP server from VoIP service provider
- **Outbound Proxy:** IP or FQDN of Outbound proxy server, helps penetrate NAT/Firewall
- **SIP User ID:** SIP username, or telephone number from ITSP
- **Authenticate ID:** Authenticate ID used by SIP proxy
- **TEL URI:** URI or Phone selection by ITSP, see webpage help tips “”
- **Authenticate Password:** Authenticate password used by SIP proxy
- **STUN Server:** STUN server used to resolve NAT if have
- **Steam:** Which stream used for SIP call. Default 2nd stream, strongly recommended due to bandwidth and data involved at video call.
- **Preferred Vocoder:** Audio codec used for SIP call, only G.711 A or U supported.
- **Registration Expiration:** Registration expiration time, default 3600 seconds
- **Local SIP Port:** Local SIP port, default 5060
- **Local RTP Port:** Local RTP port for media, default 5004
- **Auto On-Hook Timer:** Timer (in seconds) for automatic disconnecting the SIP call. Default 300.

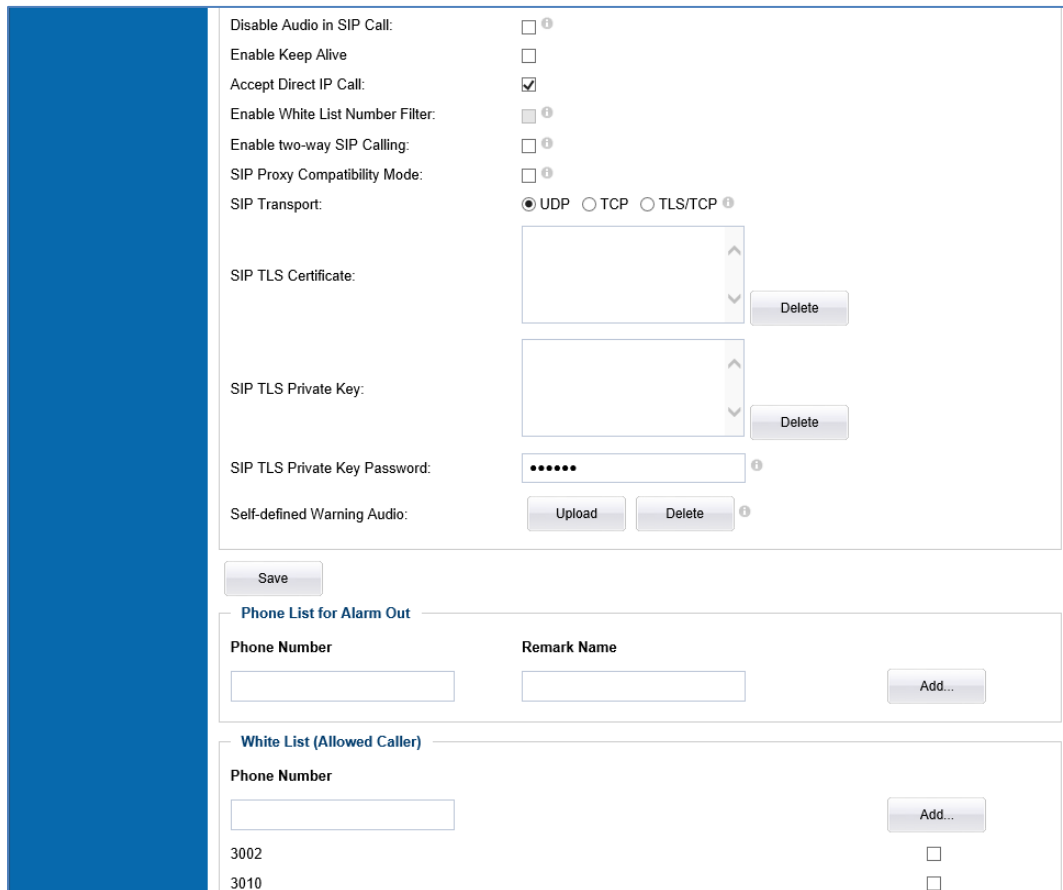

Figure 16-2: SIP Setting Page

- **Disable Audio in SIP Call:** Disable or turn off audio of camera when SIP call established.
- **Enable Keep Alive:** Checked to help NAT resolution, sending alive packets.
- **Accept Direct IP Call:** Check to accept peer-to-peer IP call in LAN w/o SIP server.
- **Enable White List Number Filter:** Check to allow only white list number to call in, for security.
- **Enable two-way Audio Warning:** Check to enable two-way audio when call established (Default)
- **SIP Proxy Compatibility Mode:** Check to enable more proxy compatibility with cost of bandwidth, the SIP call will send both audio and video no matter what.
- **SIP Transport:** SIP transport protocol, UDP as default.
- **SIP TLS Certificate:** Copy/Paste the TLS certificate here for encryption.
- **SIP TLS Private Key:** Input private key here for TLS security protection.
- **SIP TLS Private Key Password:** The password for SIP TLS private Key.
- **Self-define Warning Audio:** Upload self-defined alarm warning message audio. (Format: G.711 .WAV format, File Size <= 300KB, Linear PCM, 8KHz Sampling Rate, 16bit, Single Channel)
- **Phone List for Alarm Out:** Callee or call receiver's number when alarm call triggered.
- **White List (Allowed Caller):** Phone numbers allowed calling into the camera.

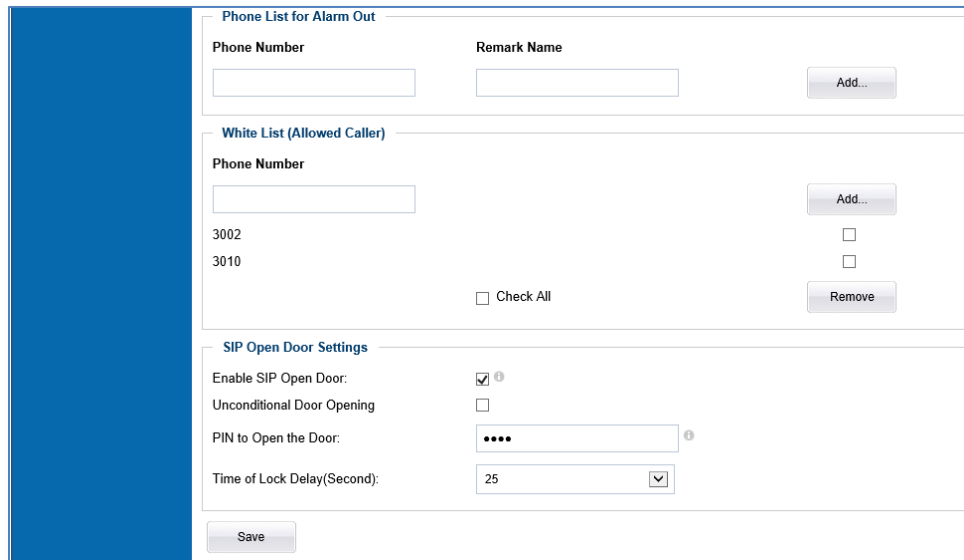

Figure 16-3: SIP Setting Page

SIP Open Door Setting

When selected, following settings will display at the webGUI:

- **Enable SIP Open Door:** allows the door to be opened remotely from phone.
- **Unconditional Door Opening:** when set to yes, then the Alarm relay will be triggered without entering the PIN to open the door.
- **PIN to Open the Door:** Password to open door
- **Delay Lock Time:** Timer (in seconds) for relay/lock to recover. (default 1 second)

NOTE:

- *When selected, this feature will override any existing Alarm Out (like Alarm In triggered Alarm Out, or Motion Detection triggered Alarm Out). The Alarm Out Port has to connect to Electric Door Strike or Relay to control door open/close.*
- *Remote SIP phone needs key in password (digits 0-9 only, ended with # key) matching the configuration here to open the door. (via DTMF)*

Status Page

This page shows the GXV3611IR_HD operation status:

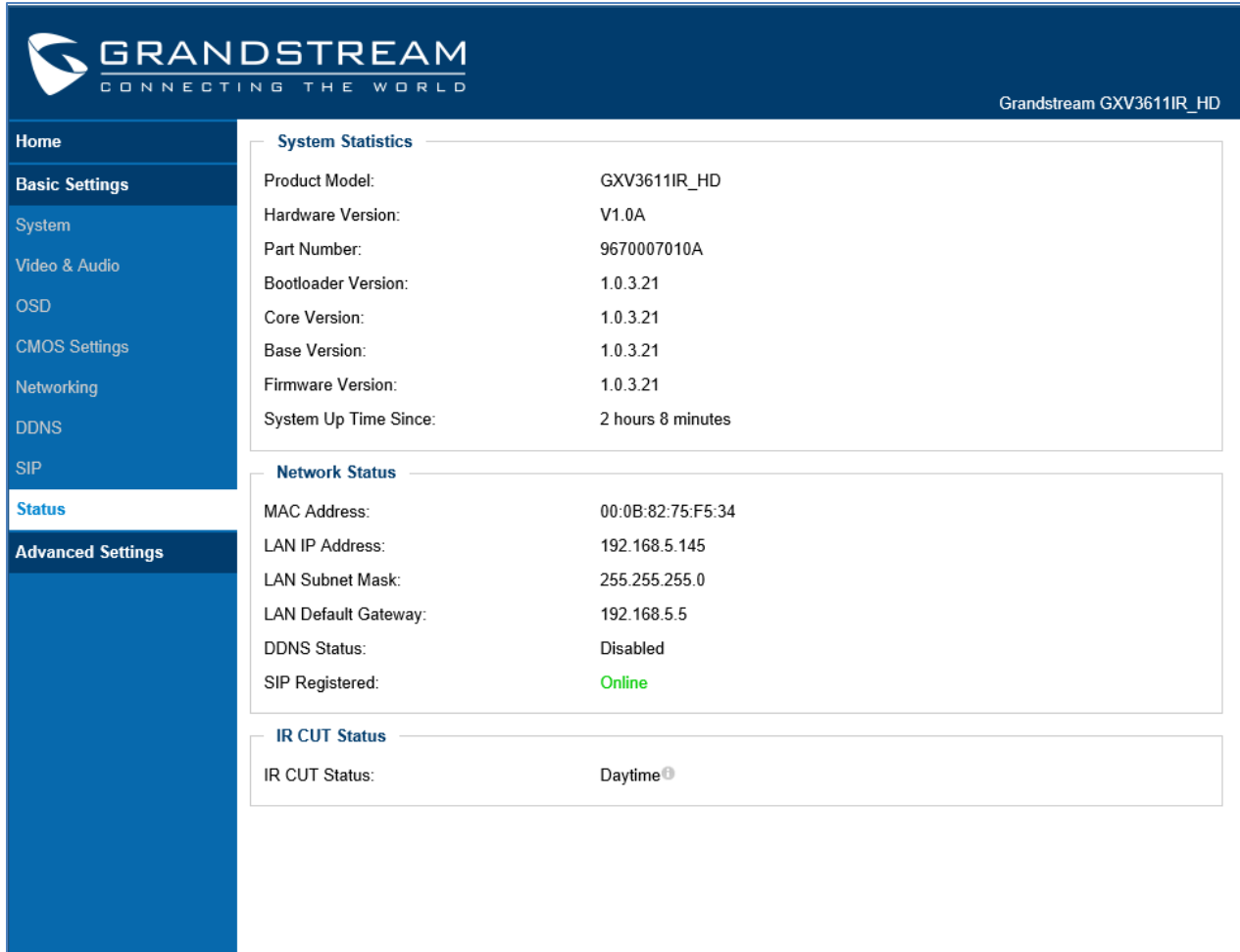

System Statistics	
Product Model:	GXV3611IR_HD
Hardware Version:	V1.0A
Part Number:	9670007010A
Bootloader Version:	1.0.3.21
Core Version:	1.0.3.21
Base Version:	1.0.3.21
Firmware Version:	1.0.3.21
System Up Time Since:	2 hours 8 minutes

Network Status	
MAC Address:	00:0B:82:75:F5:34
LAN IP Address:	192.168.5.145
LAN Subnet Mask:	255.255.255.0
LAN Default Gateway:	192.168.5.5
DDNS Status:	Disabled
SIP Registered:	Online

IR CUT Status	
IR CUT Status:	Daytime

Figure 17: Status Page

NOTE:

- *IR CUT Status will display “Daytime” or “Night” depending on current IR CUT position*
- *When SIP account registered, the status will display “Online” in Green.*
- *When SIP account unregistered, the status will display “Offline” in Red, as below.*

SIP Registered: Offline

ADVANCED SETTINGS EXPLANATION

User Management Page

This page allows user to do user management:

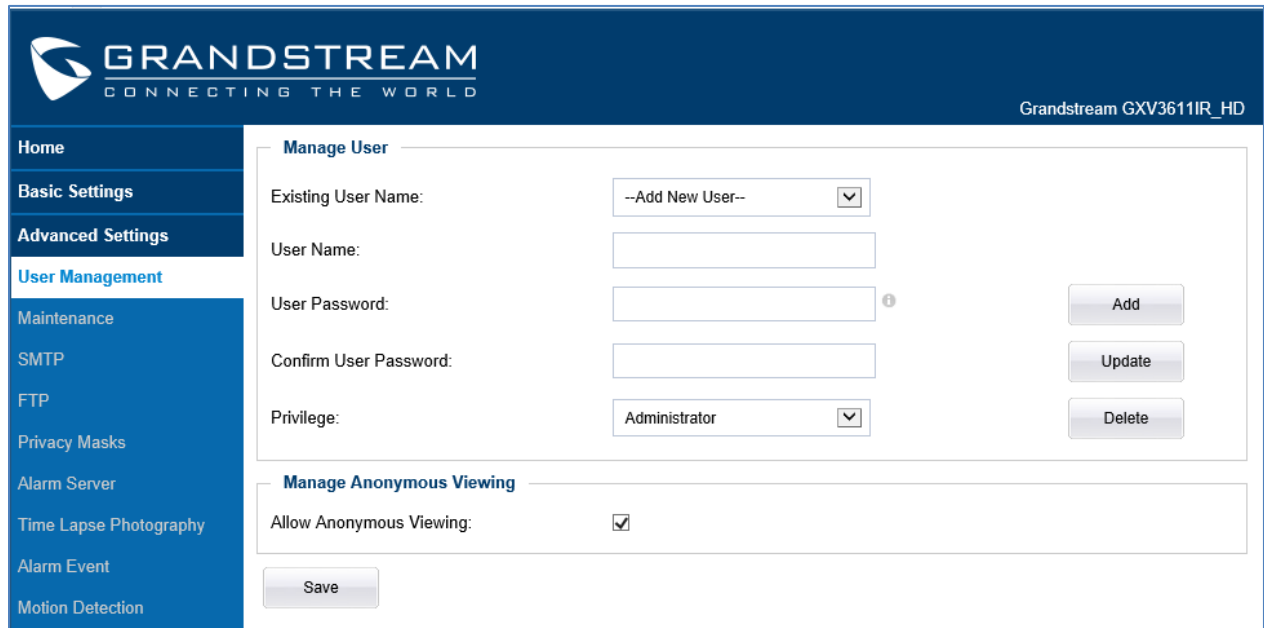

Figure 18: User Management Page

- **Existing User Name:** Allow revise existing user or add new user
- **User Name:** The name of users need to be revised
- **User Password:** New password if revise password
- **Confirm User Password:** Re-enter the new password for verification, must match.
- **Privilege:** Choose user privilege. Two levers: Administrator, Viewer. Viewer cannot change any settings.
- **Allow Anonymous Viewing:** When checked, no security enhanced. Any person can view the camera if knowing the IP or FQDN of the camera, but cannot change anything, just view ONLY.

Maintenance Page

This page allows user to maintain the camera:

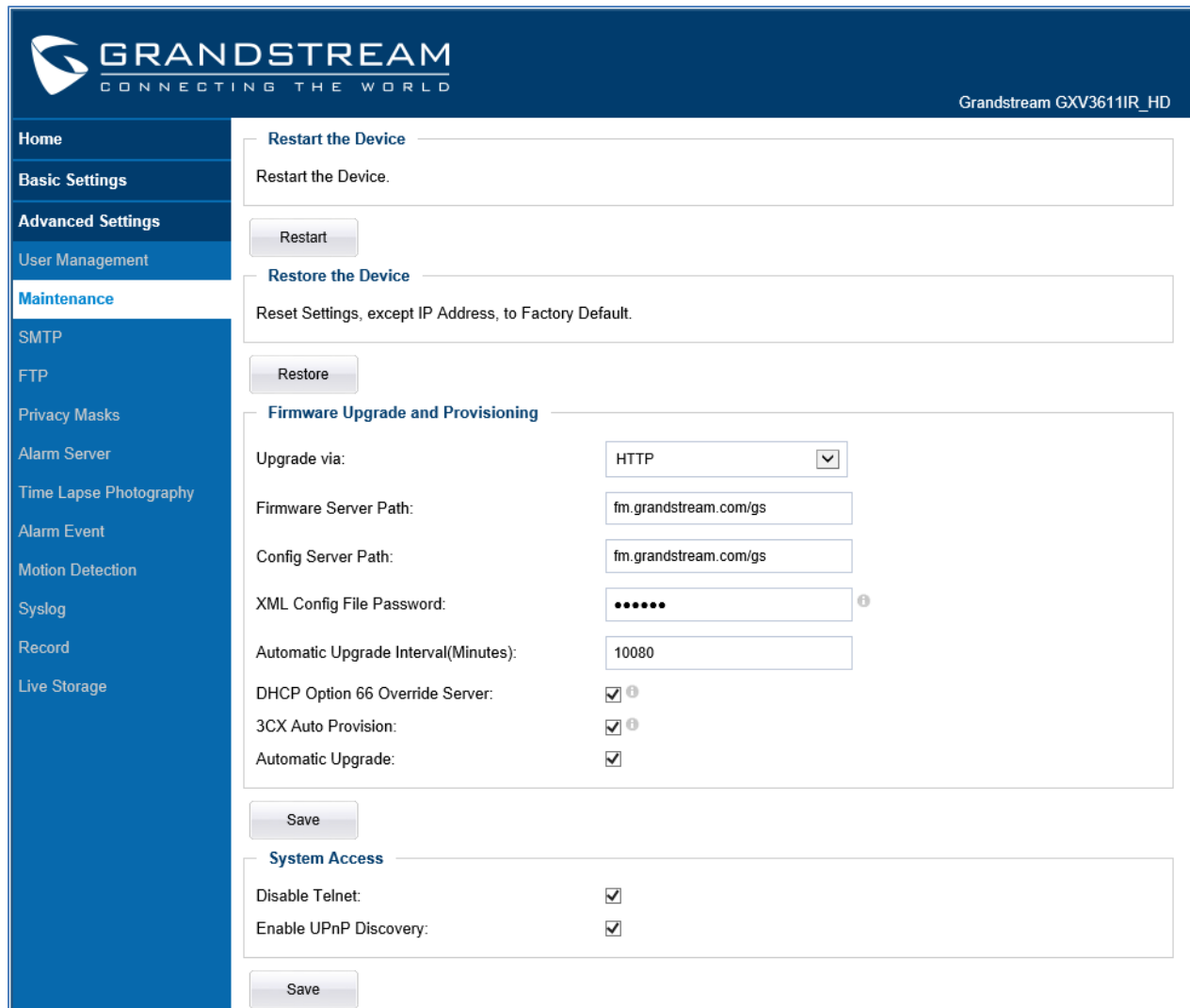

Figure 19: Maintenance Page

- **Restart:** When clicked, the camera will reboot or restart (soft reboot).
- **Restore:** When clicked, the camera will be reset to factory default, wiping out all the configurations (except IP address)
- **Upgrade via:** Upgrade firmware via TFTP, HTTP or HTTPS
- **Firmware Server Path:** Server path holding the firmware
- **Config Server Path:** Server path holding the configuration file (auto provisioning)
- **XML Config File Password:** Password for encrypt the XML based configuration file
- **Automatic Upgrade Interval (Minutes):** Time interval for automatic upgrade, default 10080
- **DHCP Option 66 Override Server:** Enabled to redirect firmware/configuration server path.

- **3CX Auto Provision:** Enabled to use 3CX as SIP server to auto provisioning the device.
- **Automatic Upgrade:** Checked to enable automatic firmware upgrade and provisioning.

System Access

- **Disable Telnet:** Check to disable Telnet to enhance security.
- **Enable UPnP Discovery:** Used for UPnP automatic discovery of the device in related network environment. Default enabled.

NOTE:

- *Only XML based automatic provisioning is supported by GXV3611IR_HD.*

SMTP Setting Page (Email Alarm)

This page allows user to configure email client to send out email when alarm triggered:

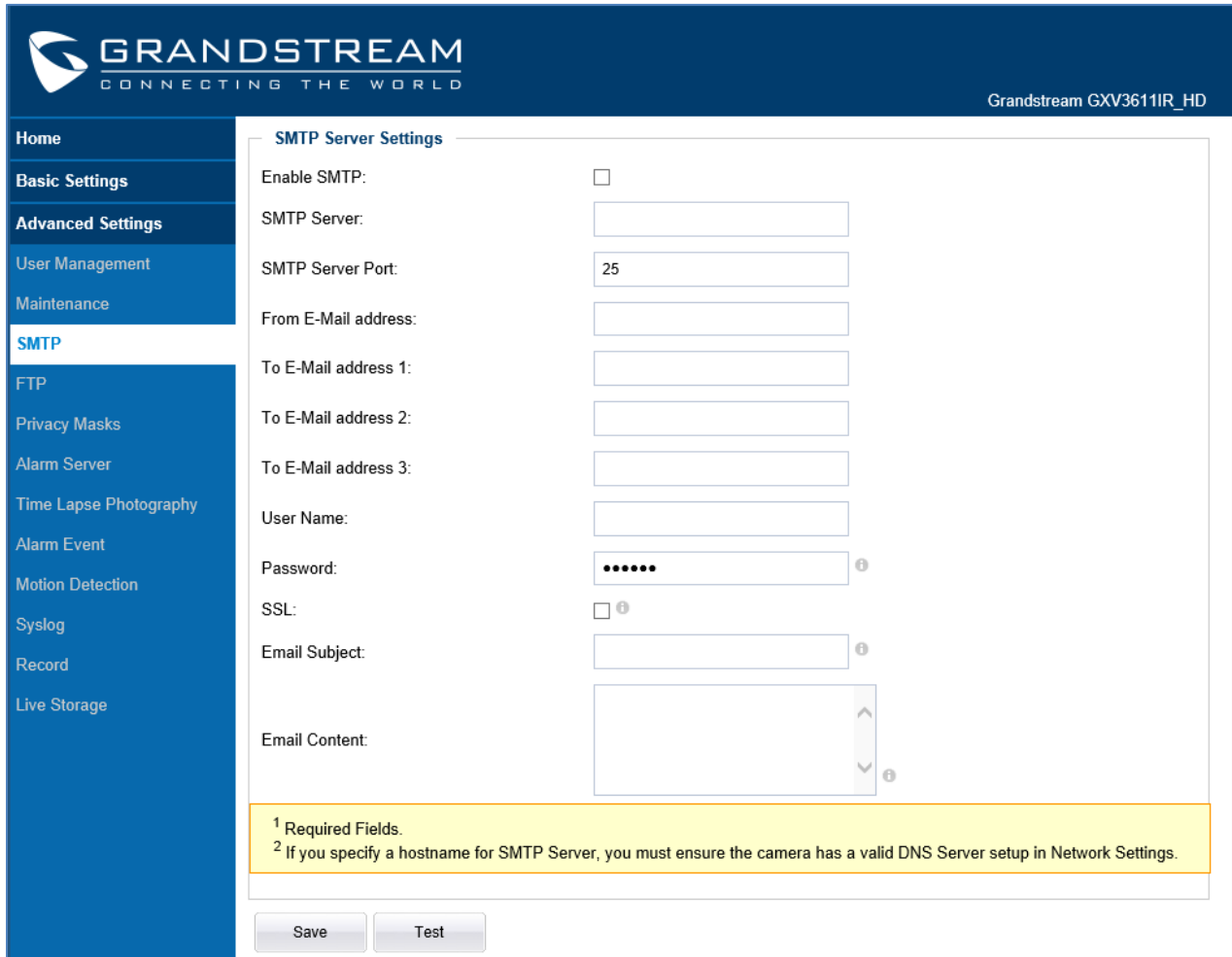

Figure 20-1: SMTP Setting Page

- **Enable SMTP:** When checked will enable email client.
- **SMTP Server:** SMTP Email Server IP or Domain Name
- **SMTP Server Port:** Port number used by server to send email
- **From Email address:** The email address of alarm email sending from, usually client email ID
- **To E-Mail address:** The email address to receive the alarmed email, total 3 included.
- **User Name:** Email client User ID
- **Password:** Email client password
- **SSL:** Check if the SMTP email server requires SSL
- **Email Subject:** Customizable email subject for user's convenience
- **Email Content:** Customizable email content for user's purpose.

NOTE:

- Click “Save” to save the email configuration information.
- Click “Test” after configuration, if setting is correct, a test email will send out and “Test successful!” orange bar will display like below

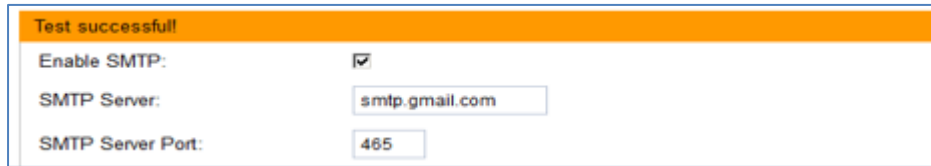

Figure 20-2: SMTP Setting Page
FTP Settings Page (Upload Alarm)

This page allows user to configure FTP parameters to upload the alarm or video recording:

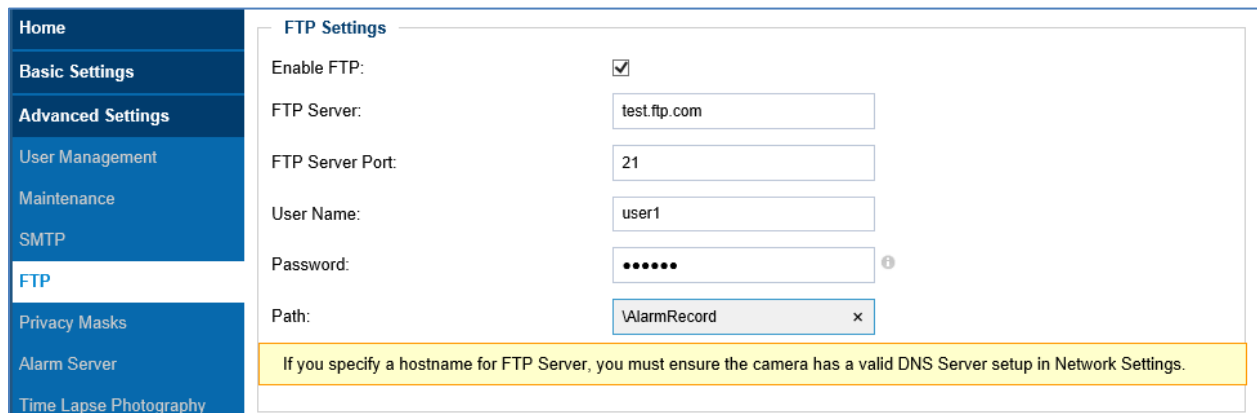

Figure 21: FTP Setting Page

- **Enable FTP:** When checked will enable built-in FTP client.
- **FTP Server:** IP or Domain name of FTP site or server
- **FTP Server Port:** TCP port for FTP server, default port number 21
- **User Name:** FTP server User ID
- **Password:** FTP server user password
- **Path:** Path in the server where upload files are stored or saved.

NOTE:

- Click “Save” to save the FTP configuration information.
- Click “Test” after configuration, if setting is correct, a test FTP operation will be performed and “Test successful!” orange bar will display if the operation is successful, like below:



Privacy Masks

This page allows user to configure privacy masks up to 4 different regions.

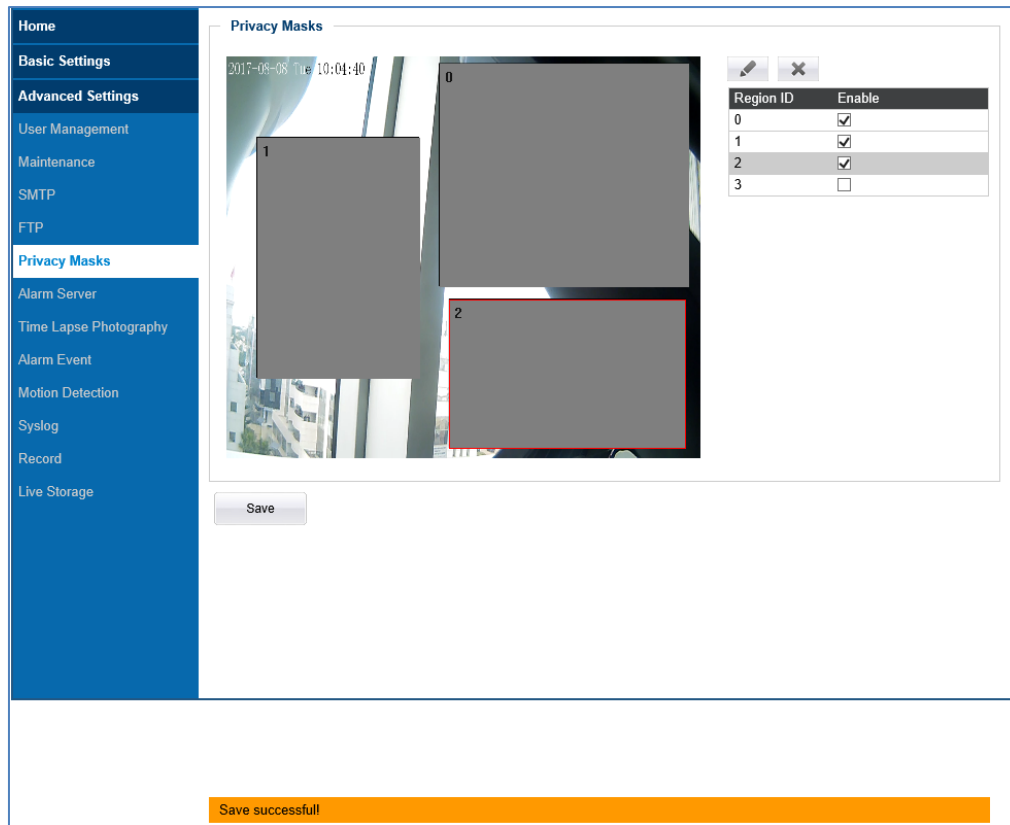

Figure 22: Privacy Masks Configuration Page

Select different region requiring privacy mask, configure and save the configuration.

When privacy mask enabled, the video at related region will be masked by black color and no video displayed inside that mask.

Alarm Server Setting Page

This page allows user to configure alarm HTTP server to upload alarms (Upload Alarms to VMS platform supported or HTTP Server for processing)

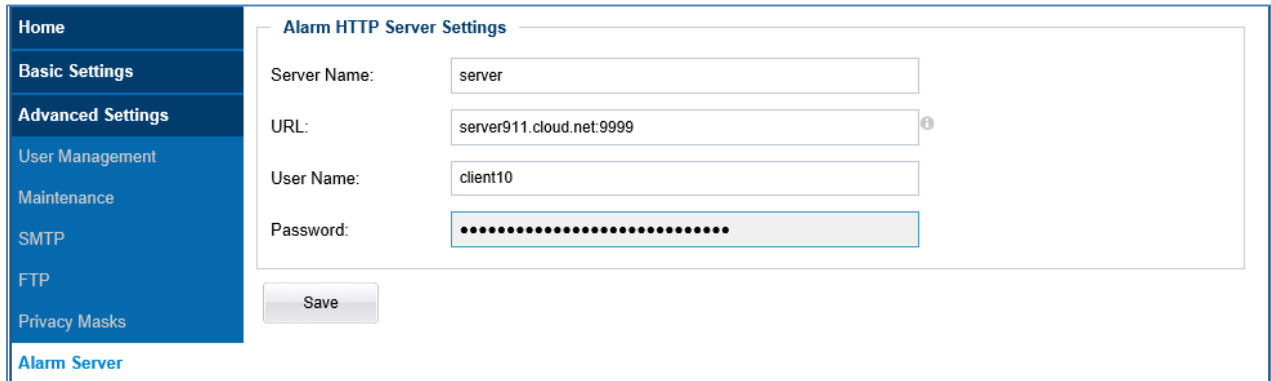

Figure 23: Alarm HTTP Server Setting Page

- **Server Name:** The name of HTTP server or VMS system
- **URL:** URL of the Server
- **User Name:** User ID from that Server
- **Password:** Password for that User ID

NOTE:

- *Grandstream provide HTTP API to help third party companies by using HTTP server or VMS to develop further solutions for their customers.*
http://www.grandstream.com/products/surveillance/general/documents/grandstream_http_api.pdf
- *Grandstream IP Camera and Encoder (include GXV3611IR_HD) are ONVIF certified.*

Time Lapse Photography

This page allows user to configure Time Lapse Photography (or period snapshot).

Home	<div style="border: 1px solid #ccc; padding: 10px;"> <p>Time Lapse Photography Settings</p> <p><input type="checkbox"/> Enable Time Lapse Photography; Trigger Every Other <input style="width: 40px; text-align: center;" type="text" value="1"/> minutes</p> <p><input type="checkbox"/> Store it to USB card or SD driver</p> <p><input type="checkbox"/> FTP Upload</p> <p><input type="checkbox"/> SMTP Upload</p> <p style="text-align: center;"><input type="button" value="Save"/></p> </div>
Basic Settings	
Advanced Settings	
User Management	
Maintenance	
SMTP	
FTP	
Privacy Masks	
Alarm Server	
Time Lapse Photography	

Figure 24: Time Lapse Photography Configuration Page

- **Enable Time Lapse Photography:** Check to enable this feature. User can configure the timer or duration of the triggering moment, minimum value is 1 minute.
- **FTP Upload:** Enabled will allow device to upload the snapshots to FTP server. The FTP server is configured at “FTP” server page illustrate before.
- **SMTP Upload:** Enabled will allow device to email the snapshots via email server. The email server is configured at “SMTP” configuration page.

Click “Save” button to save the changes made and the feature will take effect immediately.

Alarm Event

This page allows user to configure the Alarm_In event and related actions.

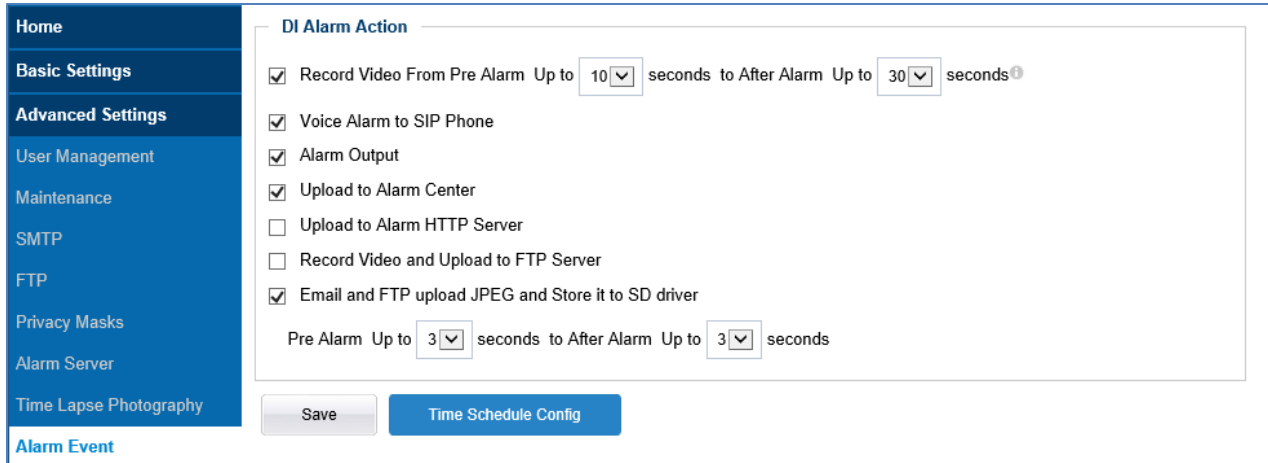

The screenshot shows the 'Alarm Event' configuration page. On the left is a navigation menu with options: Home, Basic Settings, Advanced Settings, User Management, Maintenance, SMTP, FTP, Privacy Masks, Alarm Server, Time Lapse Photography, and Alarm Event (highlighted). The main content area is titled 'DI Alarm Action' and contains the following settings:

- Record Video From Pre Alarm Up to seconds to After Alarm Up to seconds ⓘ
- Voice Alarm to SIP Phone
- Alarm Output
- Upload to Alarm Center
- Upload to Alarm HTTP Server
- Record Video and Upload to FTP Server
- Email and FTP upload JPEG and Store it to SD driver

At the bottom of the settings area, there are two more fields: 'Pre Alarm Up to seconds to After Alarm Up to seconds'. Below the settings are two buttons: 'Save' and 'Time Schedule Config'.

Figure 25-1: Alarm_In Action Configuration Page

DI Alarm Action Setting:

- **Voice Alarm to SIP Phone:** Enabled will allow device to make SIP call after receiving Alarm_In. See below NOTE for example.
- **Alarm Output:** Enabled will allow Alarm Output after receiving Alarm_In signal.
- **Upload to Alarm Center:** Upload to alarm center like 3rd party VMS system.
- **Upload to Alarm HTTP Server:** Upload to 3rd party HTTP server or application using HTTP API.
- **Record Video and Upload to FTP Server:** Upload video recording to pre-configured FTP server.
- **Email and FTP upload JPEG and Store it to SD drive:** Email, FTP and Store to the SD card the configurable trigger moment JPEG snapshots.
- **Pre/Post Alarm Recording (Record Video From Pre Alarm Up to XXX to After Up to XXX):** Depending on 1st stream resolution, this allows internal buffer to store the pre/post alarm video for applications to utilize. MJPEG is NOT supported for this feature.

Click “Save” to save the settings. Following bar will display if operation successful.

Save successful!

NOTE:

- **Voice Alarm to SIP Phone:** Application example: Intercom System, press button as Alarm_In, the pre-programmed SIP number or peer IP device will be called. If the receiver is Grandstream Video phone, the callee can use DTMF PIN code to operate and Open Door.

Time Schedule Config:

Click the “Time Schedule Config” will bring up following interface to allow user to configure the Time Schedule for the Alarm_In to take action.

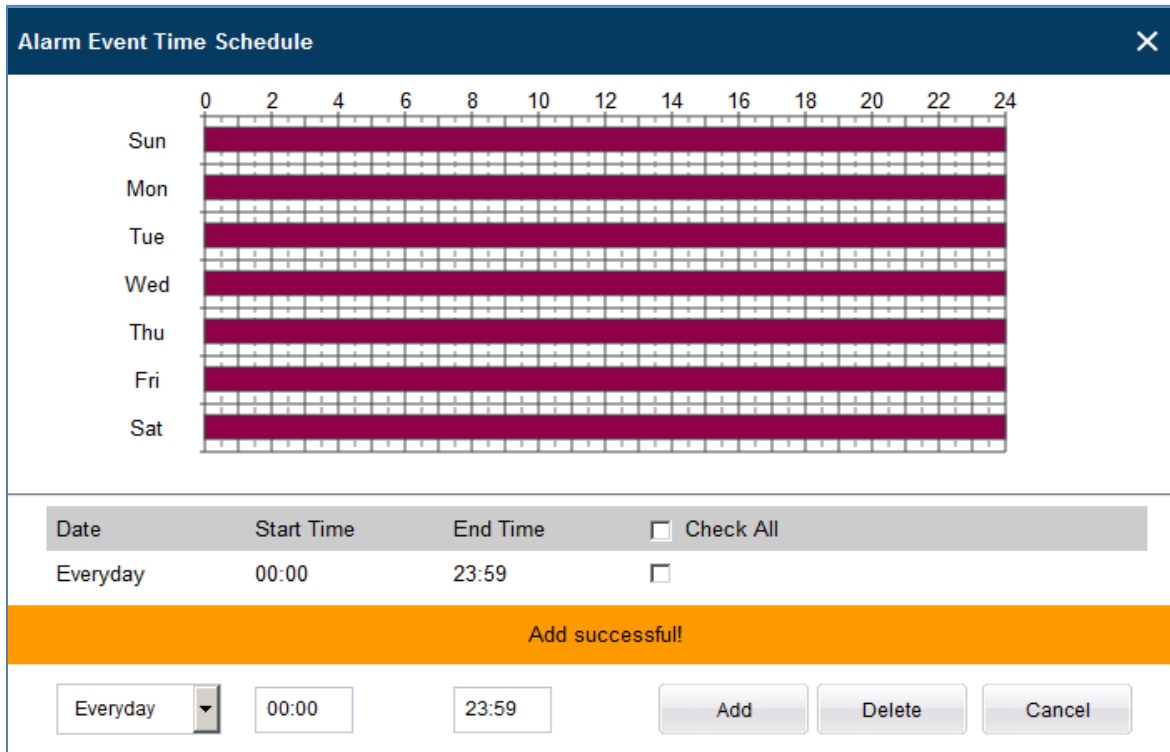

Date	Start Time	End Time	<input type="checkbox"/> Check All
Everyday	00:00	23:59	<input type="checkbox"/>

Add successful!

Figure 25-2: Alarm Event Time Schedule Configuration Page

NOTE:

- User has to configure the “Time Schedule”; otherwise the Alarm_In will not work because no schedule configured.

Motion Detection

This page allows user to configure motion detection to trigger alarms:

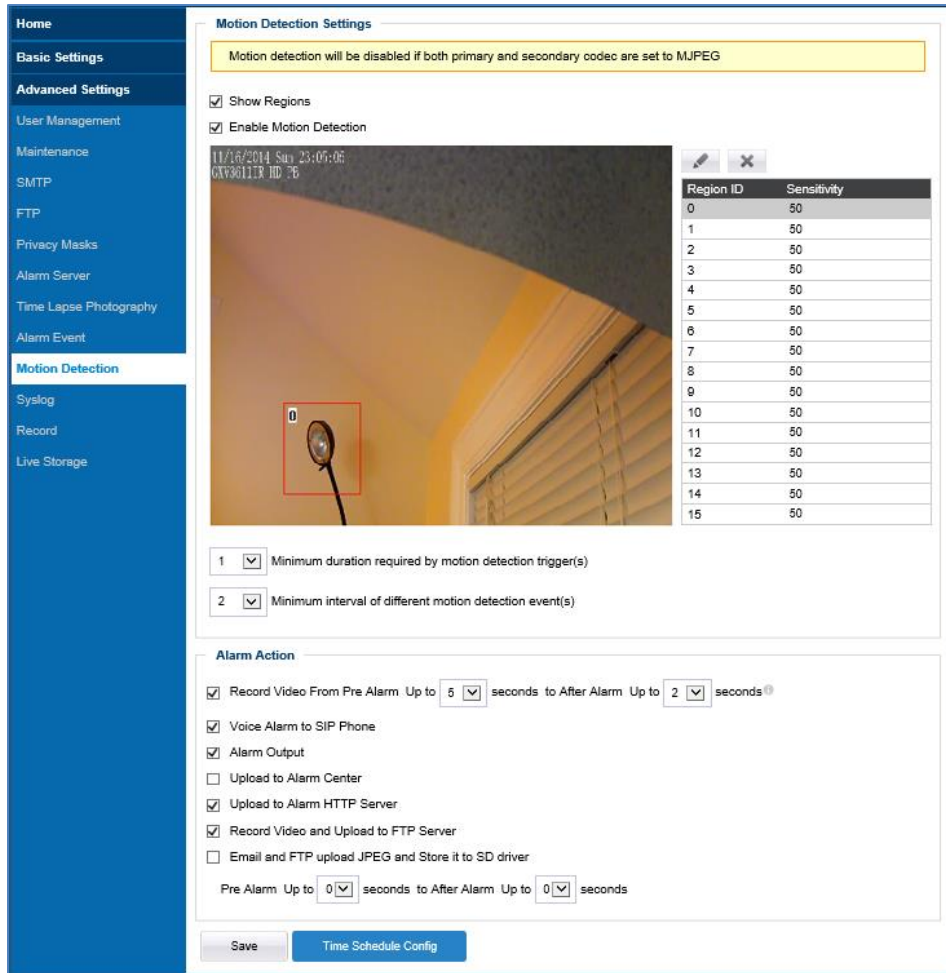

Motion Detection Settings

Motion detection will be disabled if both primary and secondary codec are set to MJPEG

Show Regions
 Enable Motion Detection

11/16/2014 Sun 23:05:06
 GXV3611IR ID 76

Region ID	Sensitivity
0	50
1	50
2	50
3	50
4	50
5	50
6	50
7	50
8	50
9	50
10	50
11	50
12	50
13	50
14	50
15	50

1 Minimum duration required by motion detection trigger(s)
 2 Minimum interval of different motion detection event(s)

Alarm Action

Record Video From Pre Alarm Up to 5 seconds to After Alarm Up to 2 seconds[®]
 Voice Alarm to SIP Phone
 Alarm Output
 Upload to Alarm Center
 Upload to Alarm HTTP Server
 Record Video and Upload to FTP Server
 Email and FTP upload JPEG and Store it to SD driver

Pre Alarm Up to 0 seconds to After Alarm Up to 0 seconds

Save Time Schedule Config

Figure 26-1: Motion Detection Configuration Page

- **Show Regions:** When checked, Motion Detection region with number will be displayed as a white rectangle in the screen. When “Edit” clicked, the Rectangle will become Red, as shown in Figure 16-1.
- **Enable Motion Detection:** When checked, Motion Detection is enabled.

There are total 16 regions be available for MD configuration, from region 0 to 15. Select and highlight the number of region to configure the MD and the sensitivity.

- **Minimum duration required by motion detection trigger(s):** Min. period (in second) to identify as a valid MD event. Default is Auto, max. value is 5 second. The setting helps to reduce false alarm based on user’s scenarios.
- **Minimum interval of different motion detection event(s):** Min. time frame (in second) to identify as different MD events if there are constant motions. Max. value is 60 seconds or 1 minute. This setting helps accuracy of MD triggered recording.

Alarm Action:

- **Record Video From Pre Alarm Up to XXX seconds to After Alarm Up to XXX seconds:**
This setting to allow configure pre/post alarm video for applications to utilize. MJPEG is NOT supported for this feature.
- **Voice Alarm to SIP Phone:**
If SIP server or peer IP device configured, check this will allow MD event to trigger alarm SIP call to pre-configured number.
- **Alarm Output:**
Select will allow MD to send alarm to Alarm Output interface.
- **Upload to Alarm Center:**
When checked, the alarm video will be transferred to Alarm Center, like Grandstream free GSurf_Pro VMS software, or 3rd party Alarm Center.
- **Upload to Alarm HTTP Server:**
When checked MD alarm will be send to 3rd path HTTP server via Grandstream HTTP API.
- **Record Video and Upload to FTP Server:**
When checked and FTP server configured, the recorded video will be send to the configured FTP server.
- **Email and FTP upload JPEG and Store it to SD driver:**
When checked, snapshots of trigger moment will be emailed to pre-configured email account and also uploaded to FTP server if configured, will also be stored to the microSD card inserted. The pre/post alarm snapshot numbers can be configured based on time (in second) to meet user's requirement.

Time Schedule Config:

Click the “Time Schedule Config” will bring up following interface to allow user to configure the Time Schedule for the Motion Detection to take action.

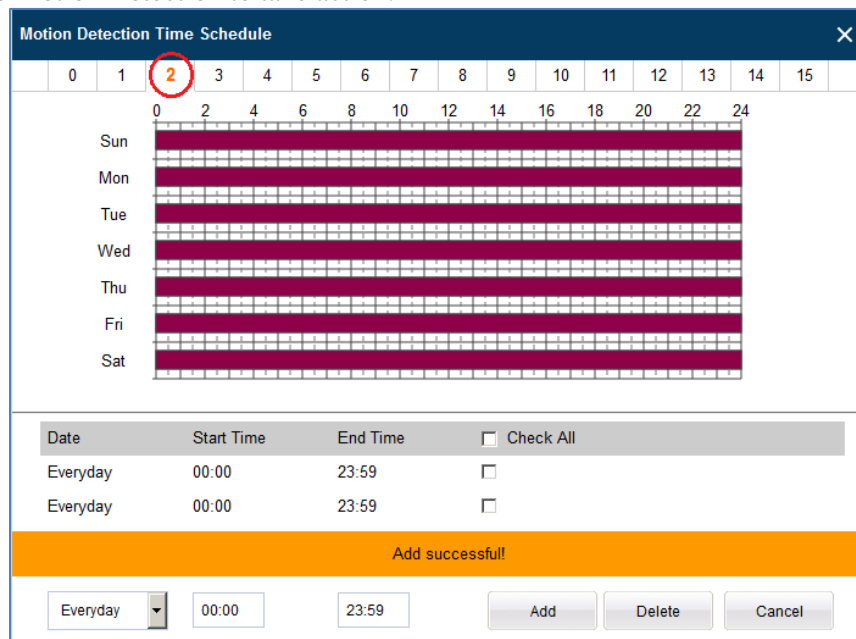

Date	Start Time	End Time	<input type="checkbox"/> Check All
Everyday	00:00	23:59	<input type="checkbox"/>
Everyday	00:00	23:59	<input type="checkbox"/>

Add successful!

Figure 26-2: Motion Detection Schedule Configuration Page

- *As shown in Figure 15-2, user can configure the Motion Detection Region with related Start and Stop time to control the motion detection operation.*

NOTE:

- User has to configure the “Time Schedule”; otherwise the Motion Detection Alarm will not work if there is no time schedule configured.
- *Grandstream free GSurf_Pro VMS software can be downloaded from:*
http://www.grandstream.com/products/tools/surveillance/gsurf_pro.zip

Syslog Settings

This page allows user to enable the Syslog to help troubleshooting problems.

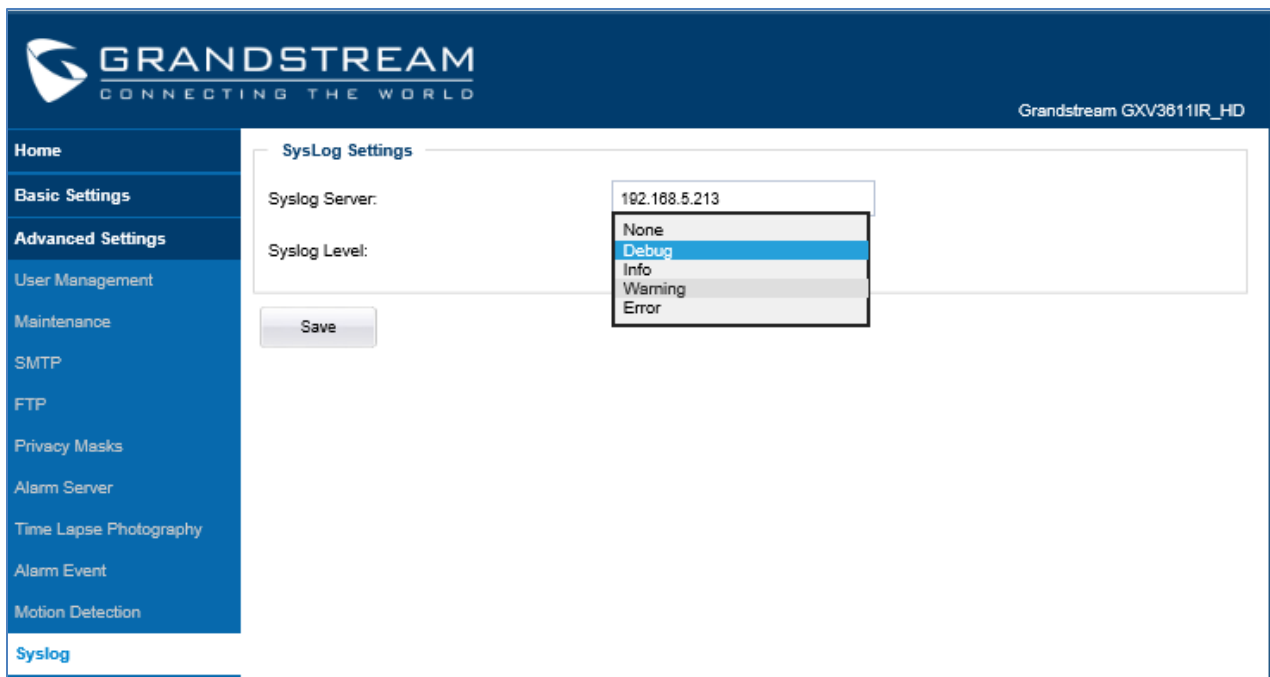

Figure 27: Syslog Setting Page

- **Syslog Server:** Syslog server IP or Domain Name
- **Syslog Level:** Lever of syslog message sent to the syslog server:
None, Debug, Info, Warning, Error.

Record

This page allows user to configure video recording schedule or manually recording. All the recording will be stored locally at SD card, and send to FTP server or HTTP API if configured properly.

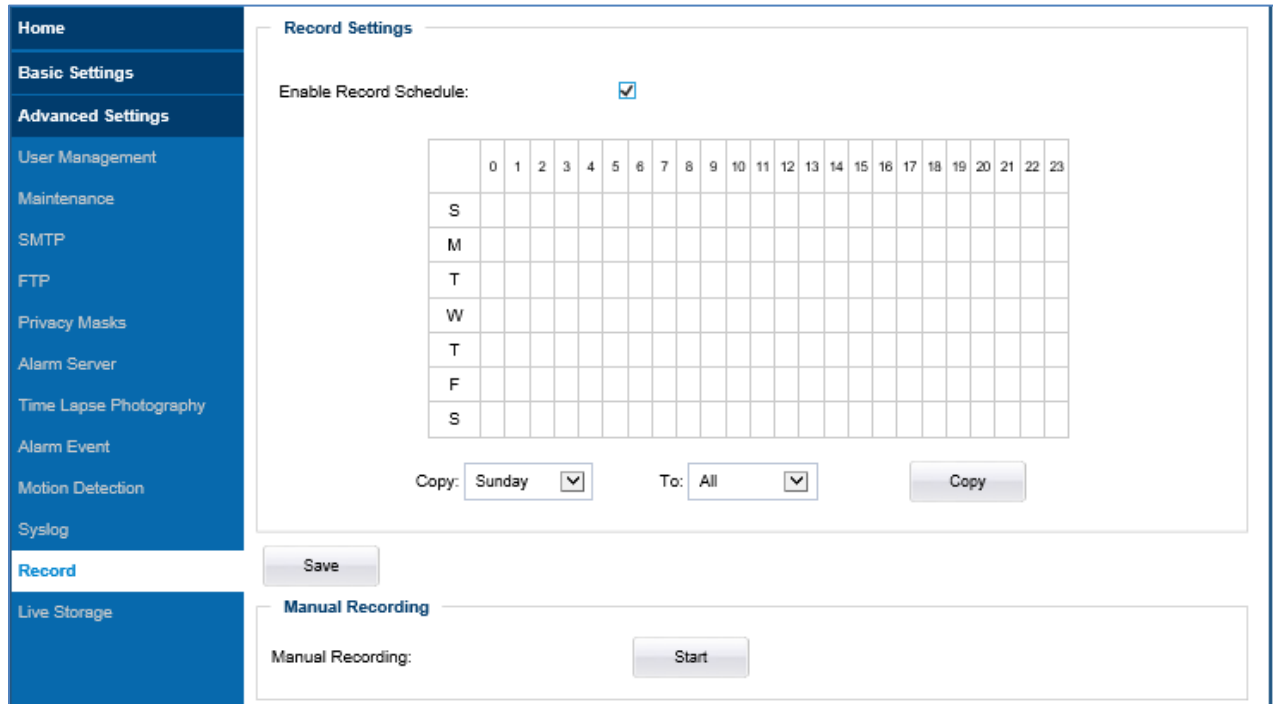

Figure 28: Record Setting Page

NOTE:

- Depending on the resolution, frame rate and bit rate of the primary stream configuration, the length of video stored on the SD could vary.
- For a 720p 10FPS 2M stream, about 5 day 7x24 video can be stored locally at a 32GB SD card.
- To store more days of activity, user can configure Motion Detection Alarm and record the triggered alarm video only in the SD card. This will give user possibility of storing more days of video in the same 32GB SD card.
- If user using GSurf_Pro or GVR3550 NVR, the above limitation will be invalid.

Live Storage

This page allows user to configure video recording on SD card.

On Disk Full

Delete the earliest video or image files ⓘ

Stop saving video and image files ⓘ

Format

Format SD Card:

Storage Information

Type	Capacity	Used Space	Free Space	Use(%)	Unmount
SD	29705M	35M	29669M	0.12%	<input type="button" value="Unmount"/>

JPEG List

File Name	Size	View	Check
192.168.11.164_chn1_2014_11_16_00_16_19.jpg	0.030M		<input type="checkbox"/>
192.168.11.164_chn1_2014_11_16_00_16_18.jpg	0.030M		<input type="checkbox"/>
192.168.11.164_chn1_2014_11_16_00_16_17.jpg	0.027M		<input type="checkbox"/>
192.168.11.164_chn1_2014_11_16_00_16_16.jpg	0.027M		<input type="checkbox"/>
192.168.11.164_chn1_2014_11_16_00_16_15.jpg	0.027M		<input type="checkbox"/>

Pages:1 Total:5 Index:1-5 Goto: Page Check All

Video List

File Name	Size	Download	Check
0_1_2014_11_16_00_19_55_139.avi	31.129M	↓	<input type="checkbox"/>
0_3_2014_11_16_00_14_09_21.avi	4.630M	↓	<input type="checkbox"/>

Pages:1 Total:2 Index:1-2 Goto: Page Check All

Figure 29: Live Storage Configuration Page

SOFTWARE UPGRADE

This page allows user to configure firmware upgrade:

Software upgrade can be done via TFTP, HTTP or HTTPS. The corresponding configuration settings are in the ADVANCED SETTINGS configuration page.

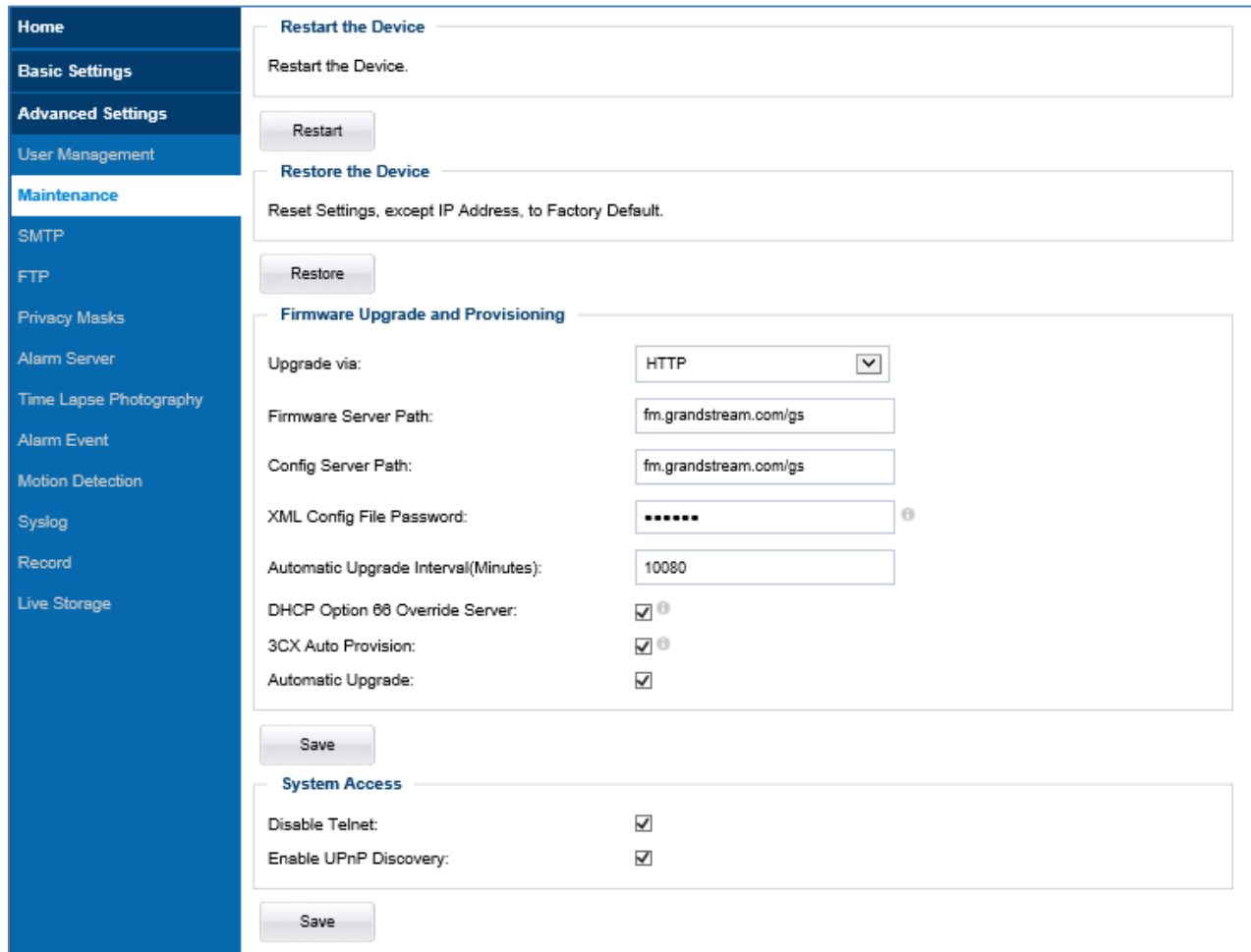

Figure 30: Firmware Upgrade and Provisioning

NOTE:

- *Grandstream recommends end-user use the Grandstream HTTP server: firmware.grandstream.com*
- *For large companies, we recommend to maintain their own TFTP/HTTP/HTTPS server for upgrade and provisioning procedures.*

Instructions for local firmware upgrade using TFTP server:

1. Unzip the file and put all of them under the root directory of the TFTP server.
2. Load the TFTP server from the PC and make sure the device in the same LAN segment.
3. Please go to File -> Configure -> Security to change the TFTP server's default setting from "Receive Only" to "Transmit Only" for the firmware upgrade.
4. Start the TFTP server.
5. In webGUI of IP camera, configure the Firmware Server Path with the IP address of the PC.
6. Update the change and reboot the unit

End users can also choose to download the free HTTP server from <http://httpd.apache.org/> or use Microsoft IIS web server.

Configuration File Download

Grandstream SIP Device can be configured via Web Interface as well as via Configuration File through TFTP or HTTP/HTTPS. "Config Server Path" is the TFTP or HTTP/HTTPS server path for configuration file. It needs to be set to a valid URL, either in FQDN or IP address format. The "Config Server Path" can be same or different from the "Firmware Server Path".

A configuration parameter is associated with each particular field in the web configuration page. A parameter consists of a Capital letter P and 1 to 3 (Could be extended to 4 in the future) digit numeric numbers. i.e., P2 is associated with "Admin Password" in the ADVANCED SETTINGS page. For a detailed parameter list, please refer to the corresponding firmware release configuration template.

When Grandstream Device boots up or reboots, it will issue request for configuration file named "cfgxxxxxxxxxxxx.xml", where "xxxxxxxxxxxx" is the MAC address of the device, i.e., "cfg000b820102ab.xml". The configuration file name should be in lower cases.

NOTE:

- *GXV3611IR_HD only support XML automatic provisioning.*
- *Grandstream recommends end-user use the Grandstream HTTP server:*

RESTORE FACTORY DEFAULT SETTING

WARNING!

Restoring the Factory Default Setting will DELETE all configuration information of the camera. Please BACKUP or PRINT out all the settings before approach to following steps. Grandstream will not take any responsibility if you lose all the parameters of setting or cannot connect to your VoIP service provider.

Reset from Web Interface (Soft Reset)

This page allows user to configure dynamic network related parameters:

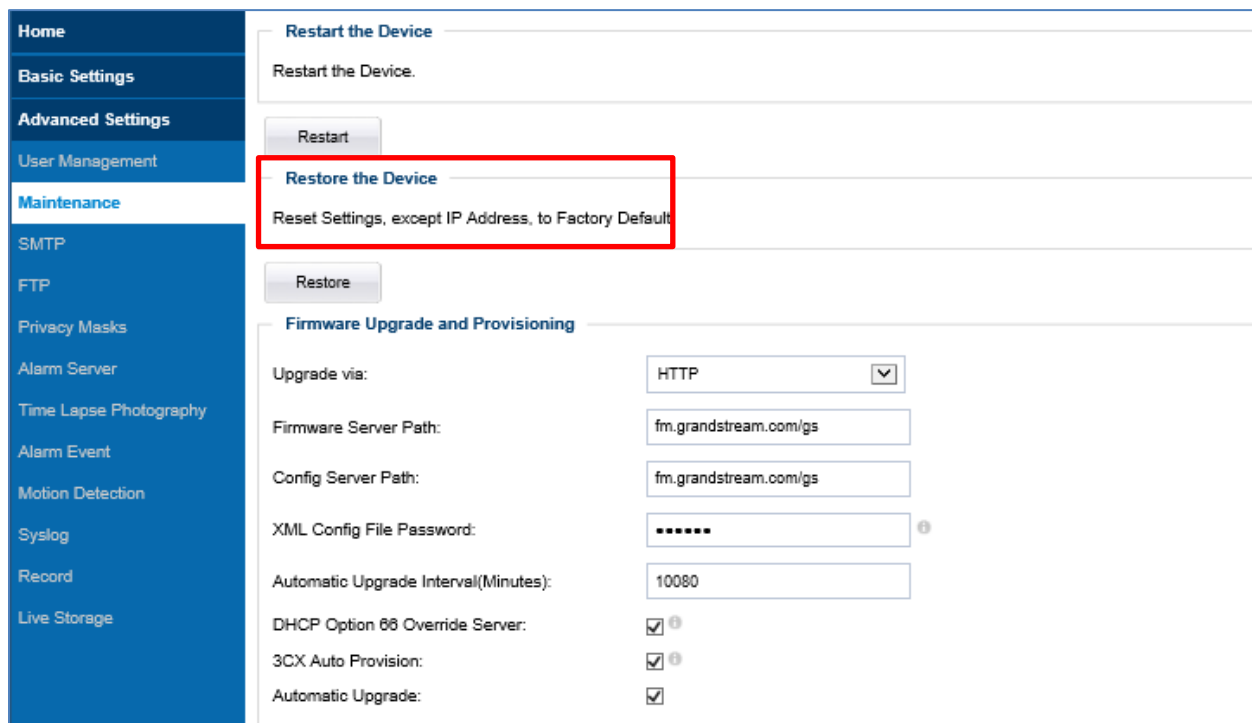

The screenshot shows the web interface with a left-hand navigation menu. The 'Maintenance' menu item is selected and highlighted in white. The main content area is divided into three sections:

- Restart the Device:** Contains the text 'Restart the Device.' and a 'Restart' button.
- Restore the Device:** This section is highlighted with a red rectangular box. It contains the text 'Reset Settings, except IP Address, to Factory Default' and a 'Restore' button.
- Firmware Upgrade and Provisioning:** Contains several configuration fields:
 - Upgrade via: HTTP (dropdown menu)
 - Firmware Server Path: fm.grandstream.com/gs
 - Config Server Path: fm.grandstream.com/gs
 - XML Config File Password: *****
 - Automatic Upgrade Interval(Minutes): 10080
 - DHCP Option 68 Override Server:
 - 3CX Auto Provision:
 - Automatic Upgrade:

Figure 31: Factory Reset from Web Interface

Reset via Button (Hard Reset)

To “hard” factory reset the camera, with the camera powered on, press and hold the “reset” button for 15 seconds until the IP camera reboot. The internal small **red** power LED will illustrate “On → Off → On”, meaning a successful hard factory reset.

Please refer to [Page 14](#) for the graphic illustration of hard reset button.

IP SURVEILLANCE FAQ

1. What is the default IP address of the GXV3611IR_HD?

The default IP configuration is DHCP or 192.168.1.168 after booting up 5 minutes.

2. Why can I not view the live video stream in Microsoft Internet Explorer?

Please double check whether the Grandstream Plug-in/Active-X is installed correctly. Once you log into the GXV3611IR_HD web interface, Internet Explorer will indicate that this website wants to install the following add-on: "GSViewer.cab" from Grandstream Networks, Inc. Please install this add-on when prompted by IE.

3. How do you manually uninstall the Grandstream video viewer add-on for IE?

Please follow these steps to uninstall the add-on:

1. Delete the *GSViewerX Control* from *C:\WINDOWS\Downloaded Program Files* directory
2. Delete *GSNetClient.dll*, *GS_Replay.exe*, *GSViewerX.ocx*, *hi_h264dec_w.dll*, *lik_VoiceEngine_dll.dll* and *GSViewerX.inf* from *C:\WINDOWS\system32*

4. Why can't I access the GXV3611IR_HD web configuration interface?

Q 1: Is your internet service down?

A 1: Connect a PC to the internet to test the connection.

Q 2: Are the PC and the device in different subnets?

A 2: Check the subnet mask and default gateway of the device and PC.

Q 3: Is there a conflict with another IP address?

A 3: Try to change the IP address of the device.

Q 4: Has the HTTP port been changed?

A 4: Contact the administrator of the device for more information.

5. The GXV3611IR_HD web configuration page is not displayed correctly in IE8 ?

In IE8, Compatibility View might need to be enabled for the GXV3611IR_HD web configuration page to load properly. To enable compatibility view, open IE8, click *Tools, Compatibility View Setting*, and add the GXV3611IR_HD web configuration pages to the Compatibility View.

6. Why does IE indicate to install Grandstream Video Viewer add-on after a firmware upgrade? The add-on was properly installed before the firmware upgrade process.

New firmware will often upgrade the add-on as well. To watch the live video stream, you must install the newest version of the add-on.

7. How do you watch secondary video stream?

Login to the home page of the GXV3611IR_HD web GUI, click Play to watch the video stream. To watch a secondary video stream, right click on the video, and select *Secondary Stream* on the pop-up menu. Try reinstalling the Grandstream Viewer add-on for IE if you cannot see the video stream.

8. What is DDNS? Is it important for IP surveillance product to have DDNS support?

DDNS is an acronym for Dynamic Domain Name Service. It is important to choose an IP network camera that has DDNS support for dynamic IP addresses. Chances are that the network has a dynamic IP address (which changes with every log on). A DDNS service makes sure that the camera's IP address always matches up to the current server address. DDNS also allows a website to be linked to the IP camera that is constantly updated with the correct information and has a reliable feed.

9. Why is Windows Media Player unable to play the recorded video files?

The GXV3611IR_HD uses the H.264 video codec. Windows Media Player may lack the proper H.264 decoder to play the recorded video. Please download the Microsoft FFDSHOW H.264 decoder from <http://sourceforge.net/projects/ffdshow-tryout/> and install it.

10. Alarm Triggered Events do not work with GSurf_Pro?

Please double check the Alarm Action on your GXV3611IR_HD. Login to the web GUI of the GXV3611IR_HD, go to the Motion Detection or Alarm Events page, and make sure option Upload to Alarm Center is checked.

11. Recommended to save the video files in different directories when using GSurf_Pro?

It is better to save video files in different directory to prevent accidental deletion of the recorded files you need.

12. How to use a cell phone to watch the GXV3611IR_HD video stream?

You must set the video resolution to QCIF to watch the GXV3611IR_HD video stream from a cell phone. Make sure to set the bit rate to 64kbps to ensure the best video quality.

13. What Smartphone application should I use to view the video?

There are free applications and paid version application for this, you can find them in Google Play for Android phone and Apple Store for iPhone, like: IP Cam Viewer:



<http://hit-mob.com/>

14. Why the IP address of the device NOT reset when clicking the “Restore” button?

The GXV3611IR_HD could be installed in areas that are not easy to access. For example, it could be installed on the roof of a building or the ceiling of an office. This makes it difficult to reinstall the device, therefore the “Restore” function will not clear the IP address.

15. Why can't the live video stream be viewed using a mobile phone or GSurf_Pro after changing the HTTP Port of the device?

Make sure that the RTSP port of the device is set to 2000 plus the HTTP Port number. For example, if the HTTP port is 88, then the RTSP port of the device that you configured on GSurf_Pro or mobile phone should be 2088.

16. Port forwarding

Two ports must be forwarded on your router to watch video from a GXV3611IR_HD that is located on a private network from a PC in a public network. The web port (HTTP) and the RTSP port. Please make note that the RTSP port number changes according to the web port. If the web port is 80, then the RTSP port is 554. If the web port is not 80, then the RTSP port equals the web port +2000. For example, if the web port is 88, then the RTSP port will be 2088.