



ErisTerminal® SIP DECT 4-Line Base Station and
ErisTerminal® SIP DECT Cordless 4-Line Handset

VDP650

VDP651

User Guide



Congratulations

on your purchase of this VTech product. Before using this product, please read **Important Safety Information** on page 4 of this manual. Please thoroughly read this user's manual for all the feature operations and troubleshooting information necessary to install and operate your product. You can also visit our website at **businessphones.vtech.com** or call **1 (888) 370-2006**.

Please note the serial number of your product, which can be found on the bottom of the base station. Save your sales receipt and original packaging in case it is necessary to return your telephone for warranty service.

This user guide contains detailed instructions for using your VDP650 ErisTerminal® SIP DECT 4-Line Base Station and VDP651 ErisTerminal® SIP DECT Cordless 4-Line Handset with software version 1.0.0.x. See "Viewing handset status" on page 50 for instructions how to check the software version of your VDP650 and VDP651. Please read this manual before using the product.

Important Safety Information



This symbol is to alert you to important operating or servicing instructions that may appear on the product or in this user's manual. Always follow basic safety precautions when using this product to reduce the risk of injury, fire, or electric shock.

Important safety instructions

When using your telephone equipment, basic safety precautions should always be followed to reduce the risk of fire, electric shock and injury, including the following:

1. This product should be installed by a qualified technician.
2. This product should only be connected to the host equipment and never directly to the network such as Public Switch Telephone Network (PSTN) or Plain Old Telephone Services (POTS).
3. Read and understand all instructions.
4. Follow all warnings and instructions marked on the product.
5. Unplug this product from the wall outlet before cleaning. Do not use liquid or aerosol cleaners. Use a damp cloth for cleaning.
6. Do not use this product near water such as near a bath tub, wash bowl, kitchen sink, laundry tub or swimming pool, or in a wet basement or shower.
7. Do not place this product on an unstable table, shelf, stand or other unstable surfaces.
8. Slots and openings in the back or bottom of the base station and handset are provided for ventilation. To protect them from overheating, these openings must not be blocked by placing the product on a soft surface such as a bed, sofa or rug. This product should never be placed near or over a radiator or heat register. This product should not be placed in any area where proper ventilation is not provided.
9. This product should be operated only from the type of power source indicated on the marking label. If you are not sure of the type of power supplied at the premises, consult your dealer or local power company.
10. Do not allow anything to rest on the power cord. Do not install this product where the cord may be walked on.
11. Never push objects of any kind into this product through the slots in the base station or handset because they may touch dangerous voltage points or create a short circuit. Never spill liquid of any kind on the product.

12. To reduce the risk of electric shock, do not disassemble this product, but take it to an authorized service facility. Opening or removing parts of the base station or handset other than specified access doors may expose you to dangerous voltages or other risks. Incorrect reassembling can cause electric shock when the product is subsequently used.
13. Do not overload wall outlets and extension cords.
14. Unplug this product from the wall outlet and refer servicing to an authorized service facility under the following conditions:
 - A. When the power supply cord or plug is damaged or frayed.
 - B. If liquid has been spilled onto the product.
 - C. If the product has been exposed to rain or water.
 - D. If the product does not operate normally by following the operating instructions. Adjust only those controls that are covered by the operation instructions. Improper adjustment of other controls may result in damage and often requires extensive work by an authorized technician to restore the product to normal operation.
 - E. If the product has been dropped and the telephone base and/or handset has been damaged.
 - F. If the product exhibits a distinct change in performance.
15. Avoid using a telephone (other than cordless) during an electrical storm. There is a remote risk of electric shock from lightning.
16. Do not use the telephone to report a gas leak in the vicinity of the leak. Under certain circumstances, a spark may be created when the adapter is plugged into the power outlet, or when the handset is replaced in its cradle. This is a common event associated with the closing of any electrical circuit. The user should not plug the phone into a power outlet, and should not put a charged handset into the cradle, if the phone is located in an environment containing concentrations of flammable or flame-supporting gases, unless there is adequate ventilation. A spark in such an environment could create a fire or explosion. Such environments might include: medical use of oxygen without adequate ventilation; industrial gases (cleaning solvents; gasoline vapors; etc.); a leak of natural gas; etc.
17. Only put the handset of your telephone next to your ear when it is in normal talk mode.
18. The power adapters are intended to be correctly oriented in a vertical or floor mount position. The prongs are not designed to hold the plug in place if it is plugged into a ceiling, under-the-table or cabinet outlet.

19. Use only the power cord indicated in this manual.
20. For pluggable equipment, the socket-outlet shall be installed near the equipment and shall be easily accessible.
21. In wall mounting position, make sure to mount the telephone base on the wall by aligning the eyelets with the mounting studs of the wall plate. Then slide the telephone base down on both mounting studs until it locks into place. Refer to the full installation instructions in "Handset Installation" on page 18 in this User Guide.
22. CAUTION: Keep small metallic objects such as pins and staples away from the handset receiver.

SAVE THESE INSTRUCTIONS

Compliance

FCC part 15

This device complies with Part 15 of the FCC rules. Operation is subject to the following two conditions: (1) This device may not cause harmful interference, and (2) this device must accept any interference received, including interference that may cause undesired operation.

This equipment has been tested and found to comply with the limits for a Class A digital device, pursuant to Part 15 of the FCC Rules. These limits are designed to provide reasonable protection against harmful interference when the equipment is operated in a commercial environment. This equipment generates, uses, and can radiate radio frequency energy and, if not installed and used in accordance with the instruction manual, may cause harmful interference to radio communications. Operation of this equipment in a residential area is likely to cause harmful interference in which case the user will be required to correct the interference at the user's expense.

Privacy of communications may not be ensured when using this phone.

Warning: Changes or modifications to this equipment not expressly approved by the party responsible for compliance could void the user's authority to operate the equipment.

Caution: To maintain the compliance with the FCC's RF exposure guideline, place the base unit at least 20 cm from nearby persons.

For body-worn operation, this handset has been tested and meets the FCC RF exposure guidelines when used with the accessories supplied or designated for this product. Use of other accessories may not ensure compliance with FCC RF exposure guidelines.

Industry Canada

This Class A digital apparatus complies with Canadian requirements: CAN ICES-3 (A)/NMB-3(A).

Cet appareil numérique de la classe A est conforme à la norme CAN ICES-3 (A)/NMB-3(A) du Canada.

This device complies with Industry Canada license-exempt RSS standard(s).

Operation is subject to the following two conditions: (1) this device may not cause harmful interference, and (2) this device must accept any interference received, including interference that may cause undesired operation of the device.

Privacy of communications may not be ensured when using this telephone.

The term "IC:" before the certification/registration number only signifies that the Industry Canada technical specifications were met.

This product meets the applicable Industry Canada technical specifications.

User Guide

ErisTerminal® SIP DECT 4-Line Base Station and ErisTerminal® SIP DECT Cordless 4-Line Handset VDP650 VDP651

Table of Contents

Important Safety Information	4	Call Waiting	28
Important safety instructions.....	4	Ignoring calls	28
Introduction	10	Dismissing calls.....	28
About this guide.....	10	Missed Calls	28
Product overview	11	Answering Internal calls.....	29
Quick Reference Guide	12	Putting a call on hold	29
Base station external features	12	Switching between two calls.....	30
Cordless handset external features..	13	About Shared Calls.....	31
Dial pad and audio controls	13	Displaying calls on the Call List.....	34
Factory Default Line Key Settings	14	Barging In	35
Base Station Installation	15	Using Key System Emulation	35
Handset Installation	18	Transferring a call.....	38
Installing the charger	18	Setting up a conference call	41
Battery installation and charging	19	Listening to messages.....	43
Wall mounting the charger.....	21	Using the Directory	43
Adding a corded headset.....	22	Using the Call History.....	45
Registering the handset to the base station	23	Using Speed Dial.....	47
Deregistering the handset	24	Configuring the Handset	48
Locating the Handset	25	Setting do not disturb.....	48
Screen icons	25	Setting call forwarding	48
Using the Handset	26	Blocking anonymous calls	49
Idle screen	26	Dialing anonymously	49
Making calls.....	26	Setting missed-call alerts.....	50
Answering Incoming calls	27	Setting call waiting.....	50
Multiple Incoming calls	27	Viewing handset status.....	50
		Setting the language.....	51
		Setting the date and time.....	51
		Setting the handset name.....	51

Configuring the programmable keys	52	Call Settings	61
Programmable Key Types	53	User Preferences	63
Line key lights	54	Base Directory	64
Setting the screen contrast	55	Blacklist	67
Backlight	55	Remote XML	67
Setting the ringer tone and volume	56	Security	67
Turning low battery tone on or off	56	Troubleshooting	68
Turning link lost tone on or off	56	General issues	68
Turning key tones on or off	56	Technical Specifications	69
Registering or deregistering your handset	57	Special characters	69
WebUI	58	Entering special characters	69
Using the WebUI	58	Maintenance	70
System Status	60	Taking care of your telephone	70
Handset Status	61	GPL License Information	71
		GPL code requests	71

Introduction

About this guide

This user guide provides information about the external features of the base station and handset, installation and handset configuration instructions, and detailed instructions for using the handset. Please read this user's manual before using your handset.

Please refer to the *VDP650 Administrator and Provisioning Manual* for complete configuration instructions. You can download the guide from

businessphones.vtech.com.

For customer service or product information, visit our website at

businessphones.vtech.com or call **1 (888) 370-2006**.

Product overview

The VTech VDP650 base station and VDP651 cordless handset is a full-featured SIP endpoint business phone system designed to work with popular hosted IP PBX services and on-premise SIP PBXs. Once you have ordered and configured your PBX service, the handset enables you to make and receive calls as you would with any other business phone. Up to 10 cordless devices (VDP651 cordless handsets and/or VDP658 cordless desksets) can be registered to the base station. Each handset provides calling features such as hold, transfer, conferencing, and speakerphone.

The VTech VDP650 base station supports shared calls among multiple cordless handsets/desksets with a single SIP account. With Key System Emulation, the line keys (L1 to L4) on handsets/desksets can be configured as KeyLine type, which enables the keys to be used as for making calls, picking up held calls, and barging in calls.

The VDP651 cordless handset features include:

- Backlit Liquid Crystal Display
- Speakerphone, Hold and Mute
- Up to 8 SIP accounts
- Up to 4 concurrent calls across all handsets
- Shared call usage on single SIP account among multiple users
- Key System Emulation
- 4 line keys (L1-L4) with LEDs (can be reprogrammed as shortcuts to other features)
- Message waiting alert LED
- 3-way conferencing
- Corded headset support
- 500-entry local directory
- 1,000-entry base directory with entries shared on all registered handsets and desksets

Quick Reference Guide

Base station external features

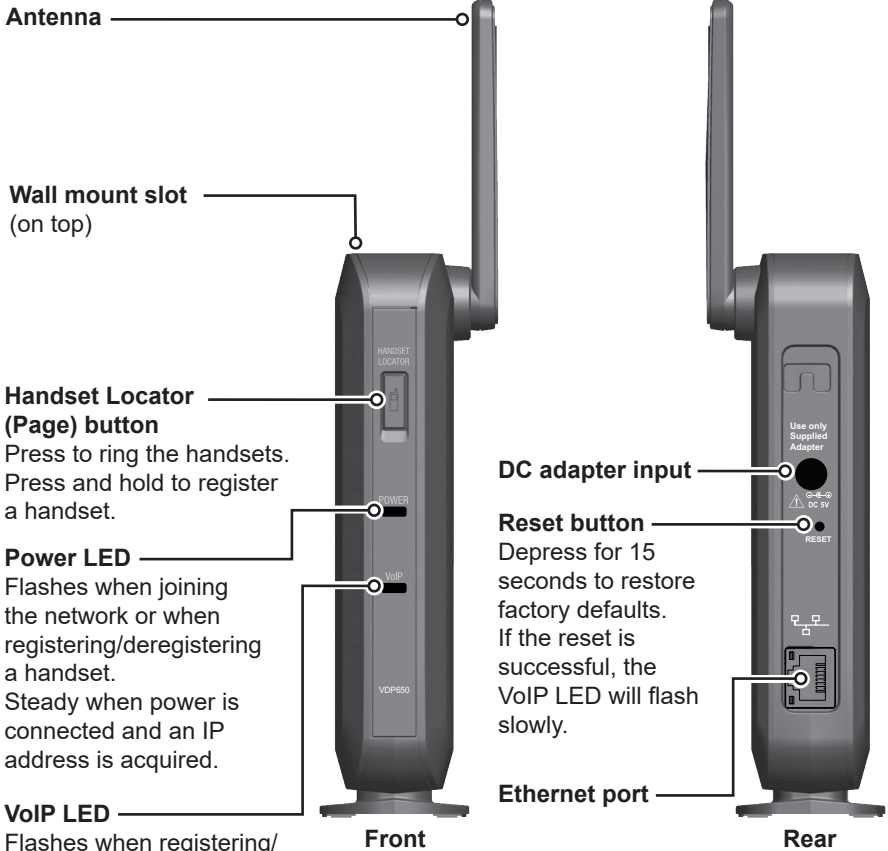
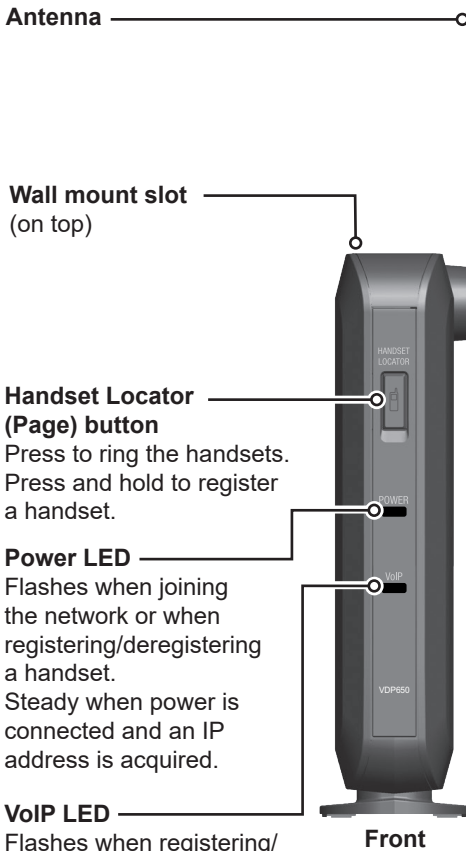

Press to ring the handsets.
Press and hold to register a handset.

Flashes when joining the network or when registering/deregistering a handset.
Steady when power is connected and an IP address is acquired.

Flashes when registering/deregistering a handset.
Steady when all SIP accounts are registered.
Off when a SIP account is not registered.

Depress for 15 seconds to restore factory defaults.
If the reset is successful, the VoIP LED will flash slowly.

Quick Reference Guide

Cordless handset external features

HEADSET JACK

2.5 mm jack for connecting a corded headset.

SOFT KEYS

Perform the actions indicated by the on-screen labels.

L1 - L4

Line keys with LEDs for call handling. Can be reprogrammed as shortcuts to other features.

CID ▼

While in menus, press ▼ to scroll down the menu. Press to display the Call history.

HOLD

Press to put a call on hold.

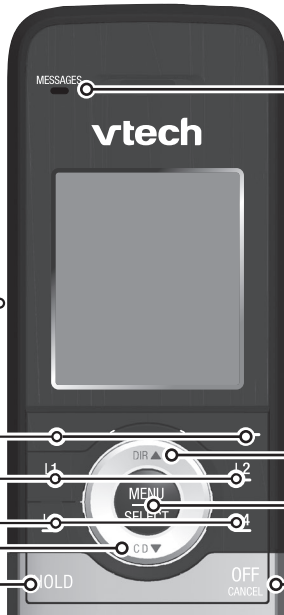

Messages light

Flashes when an account has a new voice message.

DIR ▲

While in menus, press ▲ to scroll up the menu. Press to display the Directory.

MENU/SELECT

Press to display the main menu or context menu. Press to select a menu item.

OFF/CANCEL

Press to end a call. Press to cancel an operation and leave a menu.

On back:

BELT CLIP

SPEAKER

Dial pad and audio controls

DIAL PAD

SPEAKER

Press to use the handset speakerphone.

REDIAL/PAUSE

Press to redial a number or enter a pause when programming a phone number.



HANDSET LOCK

Press and hold to lock handset keys and prevent accidental key presses.

MUTE/DELETE

During a call, press to prevent your voice from being heard. While entering numbers or letters, press to delete previous character.

Factory Default Line Key Settings

Your base station and handsets have a factory default configuration where the line keys (L1 to L4) are set up to handle a shared line.



- All handset users can use the shared line via the line keys (L1 to L4).
- The LEDs on the line keys (L1 to L4) will be on or flashing to indicate calls in progress across all handsets.
- A handset user can make a new call, pick up a held shared call, or barge in a shared call by pressing the line keys (L1 to L4).

For more information, see “Using Key System Emulation” on page 35.

Base Station Installation

This section assumes that your network infrastructure is established and that your IP PBX phone service has been ordered and configured for your location. For more information about IP PBX configuration, see the *VDP650 Administrator and Provisioning Manual*, available at

businessphones.vtech.com.

You can power the base station using a compatible VTech power adapter or using Power over Ethernet (PoE) from your network. (The base station requires PoE Class 2.) If you are not using PoE, install the base station near a power outlet not controlled by a wall switch. The base station can be placed on a flat surface or mounted on a wall in a vertical or horizontal orientation.

Avoid placing the base station too close to:

- Communication devices such as television sets, DVD players, or other cordless telephones
- Excessive heat sources
- Noise sources such as a window with traffic outside, motors, microwave ovens, refrigerators, or fluorescent lighting
- Excessive dust sources such as a workshop or garage
- Excessive moisture
- Extremely low temperature
- Mechanical vibration or shock such as on top of a washing machine or work bench

To install the base station:

1. Plug one end of the Ethernet cable into the Ethernet port on the rear of the base station (marked by ) , and plug the other end of the cable into your network router or switch.
2. If the base station is not using power from a PoE-capable network router or switch:
 - a. Connect a compatible VTech power adapter to the power jack.
 - b. Plug the power adapter into an electrical outlet that is not controlled by a wall switch.

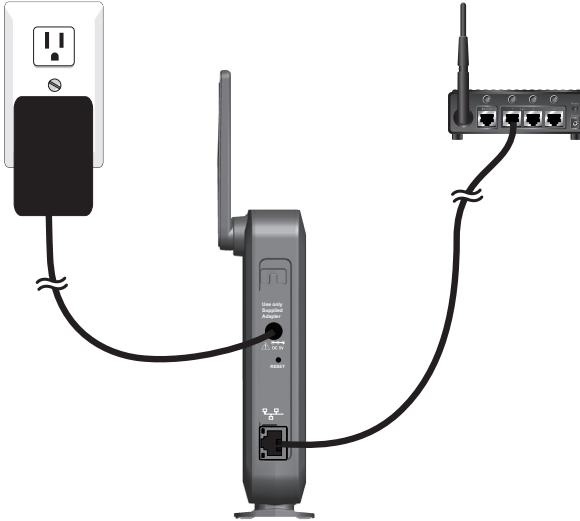

IMPORTANT INFORMATION

1. Use only a compatible VTech power adapter with this product. To order a power adapter, visit our website at **businessphones.vtech.com** or call 1 (888) 370-2006.
2. The power adapter is intended to be correctly oriented in a vertical or floor mount position. The prongs are not designed to hold the plug in place if it is plugged into a ceiling, under-the-table or cabinet outlet.

To mount the base station on a wall:

1. Install two mounting screws on the wall. Choose screws with heads larger than 5 mm (3/16 inch) in diameter (1 cm / 7/16 inch diameter maximum). The screw centers should be 5 cm (1 15/16 inches) apart vertically or horizontally.
2. Tighten screws until only 3 mm (1/8 inch) of the screws are exposed.

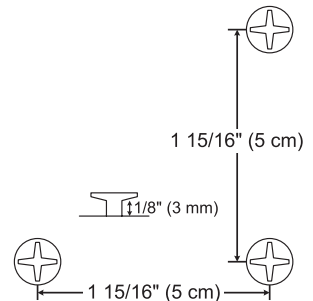

3. Attach the mounting plate to the top of the base station. Insert the tab into the slot and then push the plate in at the bottom of the base station until the mounting plate clicks into place.



4. Check to make sure the plate is secure at top and bottom. It should be flush with the base station body.
5. Place the base station over the mounting screws.

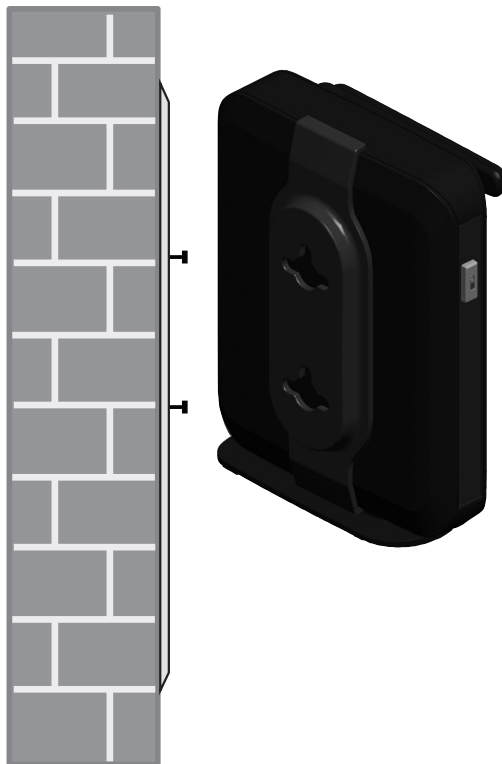

6. Connect power and the Ethernet cable as described in "To install the base station."

Handset Installation

This section assumes that your network infrastructure is established and that your IP PBX phone service has been ordered and configured for your location.

Handset installation involves both the handset and the handset charger. The charger is powered using the supplied power adapter. The charger can be placed on a flat surface or mounted on a wall.

Avoid placing the handset and charger too close to:

- Communication devices such as television sets, DVD players, or other cordless telephones
- Excessive heat sources
- Noise sources such as a window with traffic outside, motors, microwave ovens, refrigerators, or fluorescent lighting
- Excessive dust sources such as a workshop or garage
- Excessive moisture
- Extremely low temperature
- Mechanical vibration or shock such as on top of a washing machine or work bench

Installing the charger

Install the charger as shown below.

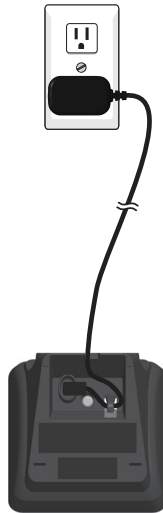

Plug the power adapter into an electrical outlet not controlled by a wall switch.



IMPORTANT INFORMATION

1. Use only the power adapter supplied with this product. To order a replacement power adapter, visit our website at **businessphones.vtech.com** or call 1 (888) 370-2006.
2. The power adapter is intended to be correctly oriented in a vertical or floor mount position. The prongs are not designed to hold the plug in place if it is plugged into a ceiling, under-the-table or cabinet outlet.

Battery installation and charging

Install the battery as shown on the following page. Once you have installed the battery, the screen indicates the battery status (see the table below). If necessary, place the handset in the charger to charge the battery. For best performance, keep the handset in the charger when not in use. The battery is fully charged after 11 hours of continuous charging.

If the screen is blank, you need to charge the handset without interruption for at least 30 minutes to give the handset enough charge to use the telephone for a short time. When the battery is low, the handset shows **Low battery** and a flashing .

Battery indicators	Battery Status	Action
The screen is blank or shows Place in charger and  flashes.	The battery has no or little charge. The handset cannot be used.	Charge without interruption (at least 30 minutes).
The screen shows Low battery and  flashes.	Battery has enough charge to be used for a short time.	Charge without interruption (at least 30 minutes).
Full battery icon () appears.	Battery is charged.	To keep the battery charged, place it in the charger when not in use.

To install the handset battery:

1. Plug the battery connector securely into the socket inside the handset battery compartment. Insert the supplied battery with the label THIS SIDE UP facing up as indicated.
2. Align the cover flat against the battery compartment, then slide it upwards until it clicks into place.



3. Charge the handset by placing it face forward in the charger. The battery icon indicates the charge status as the battery charges.

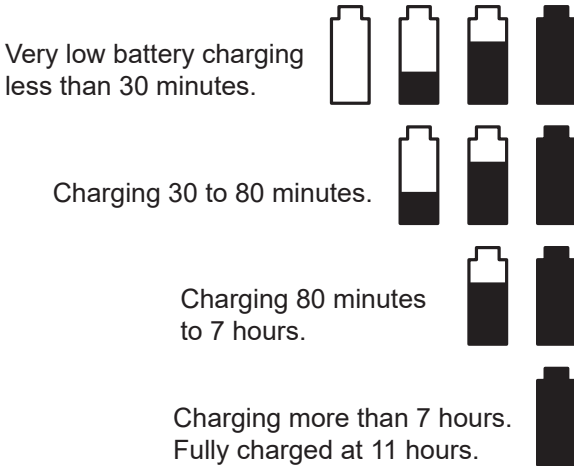

IMPORTANT INFORMATION

- Use only the supplied rechargeable battery or replacement battery (model BT264392). To order a replacement battery, visit our website at **businessphones.vtech.com** or call 1 (888) 370-2006.
- If you do not use the handset for a long time, disconnect and remove the battery to prevent possible leakage.

Wall mounting the charger

The charger is ready for tabletop use. If you want to mount the charger on a wall, use two 10 mm (7/16 inch) screws and wall anchors (not provided) to hold the charger in place. Screws and wall anchors are not provided, but are available for purchase at hardware retailers. You might need a professional to install the charger.

To mount the charger on the wall:

1. Use a pencil to mark the desired positions of the two holes on the wall. Make sure the space between the two holes is 30 mm. Drill two holes in the wall according to the marks.

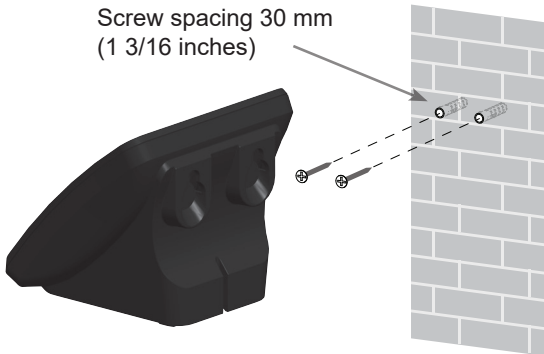

2. If you drill the holes into a stud, go to step 3.

-OR-

If you drill the holes into an object other than a stud, insert the wall anchors (not provided) into the holes and tap gently on the ends with a hammer until the wall anchors are flush with the wall.

3. Insert the screws (not provided) into the holes and tighten them until only 1/4 inch of the screws are exposed.
4. Align the holes at the back of the charger with the screws on the wall and slide the charger down until it locks into place.



Adding a corded headset

You can use this handset hands-free when you install any industry-standard 2.5 mm corded telephone headset (purchased separately).

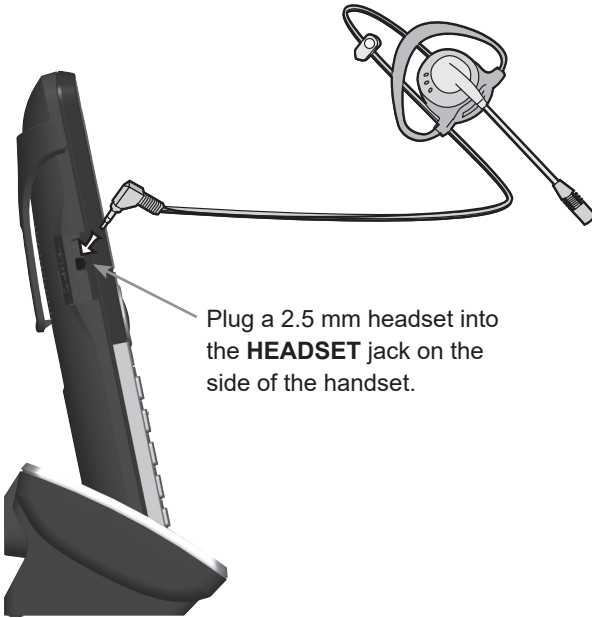

Registering the handset to the base station

The handset must be registered to the base station in order to make and receive calls.

To register the handset:

1. Make sure the handset has a charged battery before proceeding. Make sure the base station is connected to power.
2. If the handset is displaying the following message, go to step 7. Otherwise, go to step 3.

Press and hold
HANDSET LOCATOR
key at base for
4 seconds

Then, press the
#key at the
Handset.

3. Press **MENU** on the handset. The Main Menu appears.
4. Press ▼ to scroll to **User settings** and press **SELECT**.
5. Press ▼ to scroll to **Registration** and press **SELECT**.
6. With **This Handset** highlighted, press **SELECT**.
The handset screen displays instructions.
7. On the base station, press the **HANDSET LOCATOR** button for at least four seconds, then release the button. Both LEDs on the base station begin to flash.
8. Press the **#** key on the handset to begin registration.
The screen displays **Registering Please wait**.
The process takes up to 10 seconds to complete. When registration is complete, the handset beeps and displays **Handset Registered**.
If the handset fails to register, place it in the charger again for a few seconds, remove it and repeat the registration procedure.

Deregistering the handset

Before using the handset with a different base station, you must deregister the handset from the base station to which it is currently registered.

To deregister the handset:

1. Press **MENU** on the handset. The Main Menu appears.
2. Press ▼ to scroll to **User settings** and press **SELECT**.
3. Press ▼ to scroll to **Registration** and press **SELECT**.
4. Press ▼ to highlight **Deregistration** and press **SELECT**.
The handset screen displays a list of devices registered to the base station.
5. Press ▼ to highlight the name of the handset you want to deregister, and then press **SELECT**.
6. Enter the PIN, and then press **SELECT** to begin deregistration.
The default PIN is 1592.

The deregistration process takes up to 10 seconds to complete.

When the handset deregisters, it beeps and the screen displays **Handset is deregistered**, followed by the installation instructions:

Press and hold
HANDSET LOCATOR
key at base for
4 seconds

Then, press the
#key at the
Handset.

Note: The handset enters an energy-saving charging mode after being deregistered. All cordless telephone functions except handset-battery charging are disabled. Energy-saving charging mode is deactivated after the handset registers to the base station.

Locating the Handset

You can find handsets by paging them from the base. Press the **HANDSET LOCATOR** (page) button on the base station to ring all handsets:

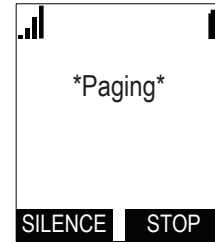

- All handsets within range of the base will ring for one minute, even if the volume is off.
- To end the locator page, press **END** .
- To silence the locator page on one handset only, press **MUTE**.

Screen icons

The following screen icons indicate your phone's current status:

Icon	Status
	Indicates signal strength, from one bar (weak) to four bars (strong). Flashes when out of range.
	Indicates battery strength from 1/3 to 3/3. Flashes when empty.
	Indicates the currently displayed call is on hold with your handset. This icon is visible when displaying the Call List.
	The ringer is off.
	Headset—audio is coming through a headset after the HEADSET key was pressed.
	Speakerphone—the speakerphone is active.
	Microphone is muted.

Using the Handset

This section describes how to use the handset to make calls and answer calls. This section also describes how to put calls on hold, transfer calls, and create conference calls.

Idle screen

The Idle screen appears after the phone is connected and configured for your SIP PBX service. The Idle screen indicates that you have no active or held calls.

From the Idle screen, you can press:

- **CALLS** to view the Call List.
See “Displaying calls on the Call List” on page 34.
- **LINE** to select another account (SIP Account).
When you make a call, the phone will use this account.
See “Making calls” below.
- **MENU** to view the main menu.
See “Configuring the Handset” on page 48.

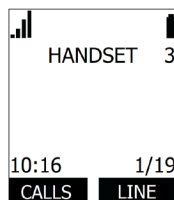

Making calls

You can make calls to any phone number (an outside call), or you can call another handset (an internal call).

To make an outside call:

1. Use the dial pad to enter the desired number.
 - Press **BACKSP** if you enter an incorrect digit.
2. Call the number by pressing an idle line key (**L1** to **L4**), **DIAL** or **SPEAKER**.

When the call is answered, the active call screen appears.

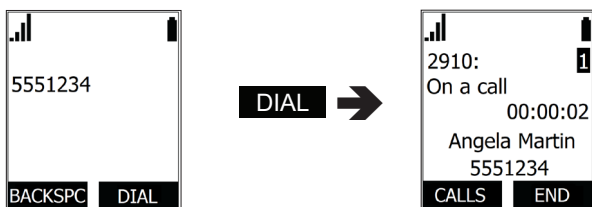

3. To hang up the call, press **OFF** or **END**.

If you wish to choose an outgoing account for the outside call:

1. Press **LINE**.
2. Press **▼** or **▲** to select the dialing line (account).
3. Press **SELECT**.
4. Use the keypad to enter the desired number.
The call will dial automatically when you have finished entering the number.

Note that you can also live dial a number by pressing an idle line key (**L1** to **L4**) or **SPEAKER** to go off hook before entering a phone number. The call will dial automatically when you have finished entering the phone number.

To make an internal call to another handset or deskset:

1. Press **MENU**.
 2. Press **▼** to scroll to **Intercom**, then press **ENTER**.
 3. Press **▼** or **▲** to select the handset you wish to call, then press **SELECT**.
- When the call is answered, the active call screen appears.

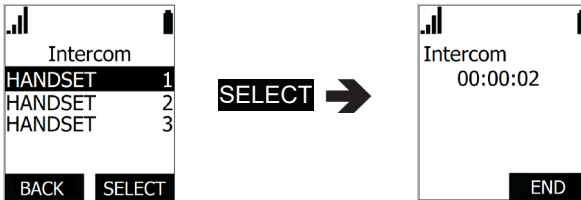

4. To hang up the call, press **OFF** or **END**.

Answering Incoming calls

You can answer a call by pressing the flashing line key (**L1** to **L4**), **SPEAKER** or **ANSWER**:

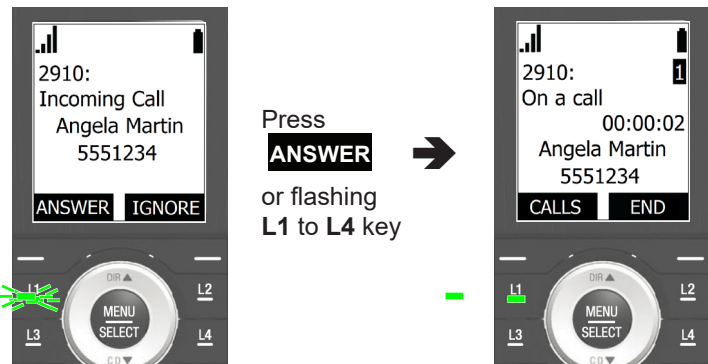

Multiple Incoming calls

If you have multiple incoming calls, (as indicated by ):

- Press the flashing line key (**L1** to **L4**) for the call you want to answer
- OR-
- Press **▼** or **▲** to select the call you want to answer and press **ANSWER**.

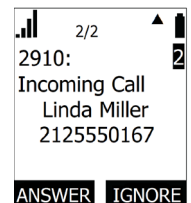

Call Waiting

If you are on a call, and receive an incoming call from an outside number, the handset displays the Call Waiting screen. If you answer the call, your active call will be put on hold.

To answer the incoming call:

- Press **ANSWER**.

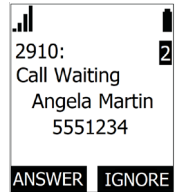

You can also ignore or reject the incoming call. See the next sections, "Ignoring calls" and "Rejecting calls."

Ignoring calls

You can ignore an incoming call from an outside number if you don't want to answer the call right away, but want to pick up the call later.

- If you ignore the call during an active call, and no other handsets/desksets answer the ignored call, your handset will ring again for the ignored call when you disconnect your call.
- If you ignore the call while your handset is idle, your handset will not ring again for the ignored call.

To ignore an incoming call:

- Press **IGNORE** on the "Incoming Call" screen or "Call Waiting" screen. The ignored call will be shown in the Call List until it is picked up by another handset/deskset. You can pick up the ignored call from the Call List - see "To view the Call List:" on page 34.

Dismissing calls

You can dismiss an incoming call from an outside number if you don't want to answer the call, and you don't want to pick up the call later.

- If you dismiss the call during an active call, the dismissed call will continue to ring on other handset/desksets until it is answered or ignored/dismissed by all handsets/desksets.
- Your handset will not ring again for the dismissed call.

To dismiss an incoming call during an active call:

1. Press **MENU** on the "Call Waiting" screen.
2. Press **YES** at the prompt, "Dismiss call? Dismissed call does not ringback."

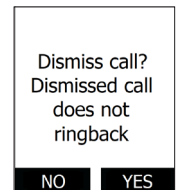

Missed Calls

If you don't respond to an incoming outside call, the handset displays a missed-call alert on the idle screen.

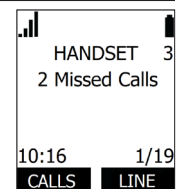

Answering Internal calls

You can receive internal calls from another handset/deskset.

To answer an internal call:

- Press **ANSWER** .



Internal calls from another handset/deskset cannot be rejected, but they can be silenced by pressing **MUTE**.

Putting a call on hold

You can put an outside call on hold by pressing **HOLD**. The handset also puts calls on hold automatically when you answer another call, transfer a call, or create a conference. Note that you cannot put an internal call on hold.



To take the call off hold:

1. Press **CALLS** .
2. If you have multiple calls on hold, (as indicated by ) , press ▼ or ▲ to select the call you want to take off hold.
3. Press **RESUME** .

If another party puts you on hold, you may see the message **Held by far end**. This message depends on compatibility between phones and PBX types, and may not always appear. You can press **END** to end the call.

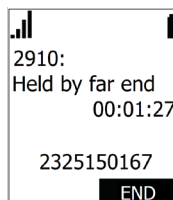

To make a new call while on hold:

1. When you have a call on hold, use the dial pad to enter the number you wish to dial.
2. Call the number by pressing an idle line key (**L1 to L4**), **DIAL** or **SPEAKER**.

Switching between two calls

If you are managing two calls, you can switch between them by one of the following ways:

- Press the flashing line key (**L1 to L4**) of the call you want to pick up.

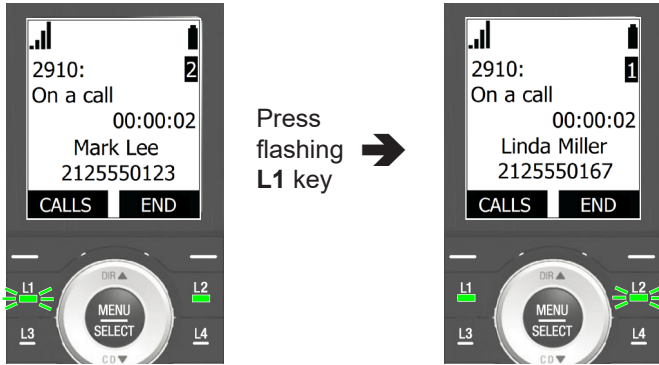

-OR-

- Press **CALLS**, and then press **RESUME** :



About Shared Calls

A shared call is a call that can be picked up by any handset/deskset on a shared line.

Active and held shared calls are shown in the Call List, which can be displayed by pressing **CALLS** on your handset.

Private calls are only visible to the handset/deskset user who makes or answers the call.

Your system administrator will determine whether or not calls on a SIP account will be shared among handset/deskset users.

Whether or not calls on a SIP account will be shared among other handset/deskset users is configured by your system administrator via KeyLine assignment.

The following examples show how to use the Call List to pick up a held shared call and barge in an active shared call. Each example shows what the screen looks like on two different handsets.

Example - picking up a held shared call:

	Alice's handset	Bob's handset
1. Alice is on a call.		
2. Alice presses HOLD to put the call on hold.		
3. Alice shouts across the room, "Bob, can you pick up line 2?"		
4. Bob presses CALLS to display the Call List, and presses ▼ to select the call on line 2.		
5. Bob presses RESUME to pick up the call.		
The call is now on Bob's handset.		

Example - barging in a shared call:

	Alice's handset	Bob's handset
1. Alice is on a call.		
2. Alice shouts across the room, "Bob, can you join my call on line 3?"		
3. Bob presses CALLS to display the Call List, and presses ▼ to select the call on line 3.		
4. Bob presses BARGE to barge in the call.		
Bob is now in a conference call with Alice and the caller on line 3.		

Displaying calls on the Call List

The Call List enables you to manage your own calls and shared calls within the system. The Call List displays:

- Shared calls on other handsets/desksets, which can be active, held, or barged-in calls.
- Calls held by your handset whether shared or private (indicated by ).
- Calls you ignored calls, which not are yet answered by other handsets/desksets.

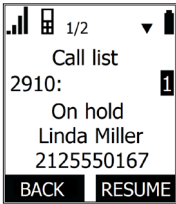

In the Call List, a number on the handset display indicates which **L1-L4** key is assigned to the call.

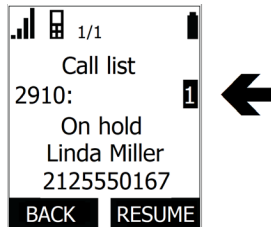

To view the Call List:

1. Press **CALLS** .
2. If there are multiple calls in the Call List, (as indicated by ), press **▼** or **▲** to select a call.
3. To retrieve a call on hold, press **RESUME** .
4. To “barge in” on a shared call, press **BARGE** .
5. To answer a call you previously ignored, press **ANSWER** .
6. To exit the Call List, press **BACK** .

Barging In

You can “barge in” on a shared call in progress on another handset/deskset that shares the account. Barging in establishes a three-way call with two internal parties. Only one barge in party is allowed per active call.

To barge in on a call:

- Press the steady green line key (**L1** to **L4**) of the call you want to barge in.
-OR-
1. Press **CALLS** to display the Call List.
 2. Press ▼ or ▲ to select the call you want to barge in.
 3. Press **BARGE** .

Using Key System Emulation

Your phone is equipped with Key System Emulation, where four line keys (**L1** to **L4**) enable direct interaction with shared calls. The line keys (**L1** to **L4**) act like shortcuts to the calls in the Call List.



Key System Emulation can be useful for small businesses where incoming calls are answered by a group of people.



Handset users can use the line keys to make new calls, answer incoming calls, pick up calls held by other users, or barge in other users' calls.

The following examples show how to use the line keys (**L1** to **L4**) to pick up a held shared call and barge in an active shared call. Each example shows what the screen and line key LEDs look like on two different handsets.

Example - picking up a held shared call:

	Alice's handset	Bob's handset
1. Alice is on a call.		
2. Alice presses HOLD to put the call on hold.		
3. Alice shouts across the room, "Bob, can you pick up line 2?"		
4. Bob presses L2 to pick up the call.		
The call is now on Bob's handset.		

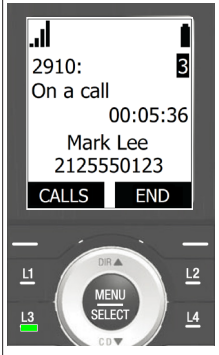
Example - barging in a shared call:

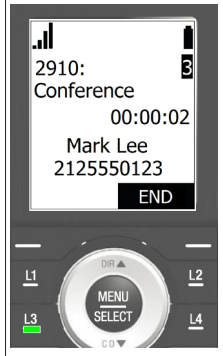
	Alice's handset	Bob's handset
1. Alice is on a call.		
2. Alice shouts across the room, "Bob, can you join my call on line 3?"		
3. Bob presses L3 to barge in the call.		
Bob is now in a conference call with Alice and the caller on line 3.		

LEDs on the line keys (**L1-L4**) indicate the status of calls:

LED light	Indicates:	Press key to:
Off	Line is idle	Make a call
Fast flashing green	Ringing incoming call	Answer the call
Slow flashing green	Call is on hold on your handset OR another handset/deskset	Retrieve the held call
Steady green	Call is active on your handset; OR shared call is active on your handset or another handset/ deskset	“Barge in” on the shared call

Your phone system has its factory default with SIP Account 1 and its four line keys (**L1-L4**) configured to provide a Key System experience. Ask your system administrator for other modes of operation.

Transferring a call

You can transfer a call to another party.

If you talk to the transfer recipient before completing the transfer, you are making a “supervised” transfer.

However, the transfer recipient does not have to talk to you before receiving the transferred call. If you do not talk to the transfer recipient before transferring the call, you are making a “blind” transfer.

You can also transfer a call to a held call. Note that you cannot transfer internal calls.

To transfer a call (supervised):

1. During a call, press **SELECT**.
2. Press ▼ to scroll to **Transfer** and press **SELECT**.



SELECT ➔

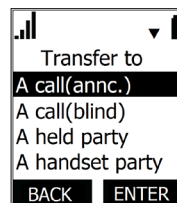

3. With **A call(annc.)** highlighted, press **SELECT**.
The call is automatically put on hold.
4. Dial the number to which you want to transfer the call. Wait for the phone to automatically dial, once it recognizes a valid number.

OR

Press ▼ (Call History) or ▲ (Directory) and call a number from a list.

- When the second caller answers, you can talk to the caller to notify them of the transfer, then press **TRANS.** to transfer the call.

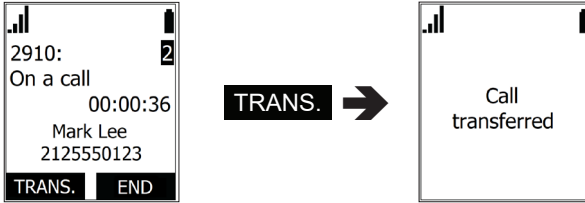

To transfer a call (blind):

- During a call, press **SELECT**.
- Press ▼ to scroll to **Transfer** and press **SELECT**.



- Press ▼ to scroll to **A call(blind)**, then press **SELECT**.
- Dial the number to which you want to transfer the call.

OR

Press ▼ (Call History) or ▲ (Directory) and call a number from a list.

- Press **TRANS.** to transfer the call.

When the far end picks up, the call will be immediately transferred.

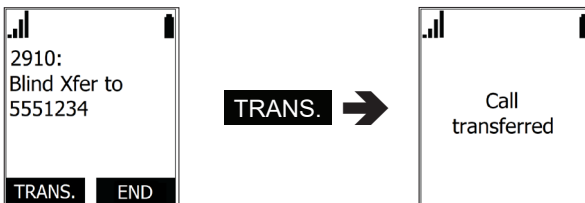

To transfer a call to a held call:

1. During a call, press **SELECT**.
2. Press ▼ to scroll to **Transfer** and press **SELECT**.



3. Press ▼ to scroll to **A held party**, then press **SELECT**.
4. Press ▼ or ▲ to select a held call to which you want to transfer, then press **SELECT**.
5. When the second call is established, you can talk to the caller to notify them of the transfer.
6. Press **TRANS.** to transfer the call.

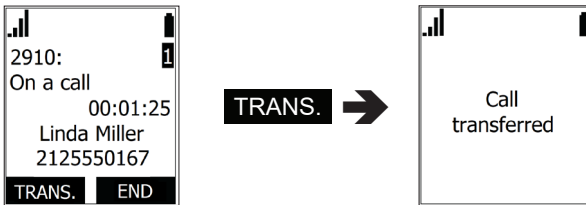

To transfer a call to another handset / deskset in your system:

1. During a call, press **SELECT**.
2. Press ▼ to scroll to **Transfer** and press **SELECT**.



3. Press ▼ to scroll to **A handset party**, then press **SELECT**.
4. Press ▼ or ▲ to select a handset or deskset, then press **SELECT**.
5. When the second call is established, you can talk to the caller to notify them of the transfer.
6. Press **SELECT**.
7. With **Transfer** highlighted, press **SELECT** to transfer the call.

Setting up a conference call

You can hold a conference call between yourself and two other parties.

To set up a conference call with an outside number:

1. During a call, press **SELECT**.
2. Press ▼ to scroll to **Conference** and press **SELECT**.



SELECT →



3. With **A new party** highlighted, press **SELECT**.
The call is automatically put on hold.
4. Dial the second number for the other party you want to join your conference.
Wait for the phone to automatically dial,
once it recognizes a valid number.

OR

Press ▼ (Call History) or ▲ (Directory) and call a number from a list.

5. When the second call is established, press **CONF**.
The conference begins and the conference screen appears.

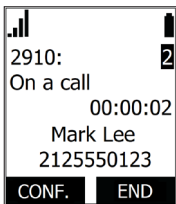

CONF. →

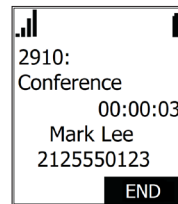

Press **END** to terminate both calls and end the conference.

To create a conference with a held call:

1. If you are on an Active call and also have a call on hold, press **SELECT**.
2. Press ▼ to scroll to **Conference** and press **SELECT**.



3. Press ▼ to scroll to **A held party**, and then press **SELECT**.
A list of held calls will appear.
4. Press ▼ or ▲ to select a held call you want to conference with, then press **SELECT**.
5. Press **CONF**.
The conference will begin immediately.

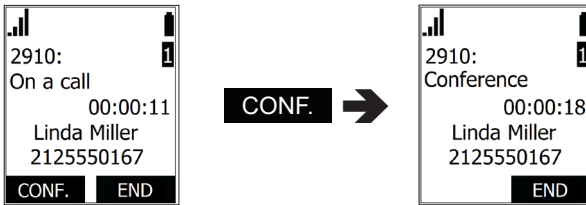

Press **CANCEL** to terminate both calls and end the conference.

To set up a conference call with another handset / deskset in your system:

1. During a call, press **SELECT**.
2. Press ▼ to scroll to **Conference** and press **SELECT**.



3. Press ▼ to scroll to **A handset party**, then press **SELECT**.
4. Press ▼ or ▲ to select a handset or deskset, then press **SELECT**.
5. When the second call is established, press **SELECT** and press ▼ to scroll to **Conference**, then press **SELECT**.

The conference begins and the conference screen appears.

Press **END** to exit the conference. The two other callers remain connected to each other.

Setting up a Network Conference:

A Network Conference is hosted by your service provider and allows multiple parties to join a conference. A Network Conference works in a similar way to the regular conference described above, except you can add as many parties as your service provider supports. Pressing **MENU** and selecting **Conference** during a conference will allow you to add more parties to the ongoing conference.

Listening to messages

When you have new messages, the phone displays a new-messages notification on the idle screen:

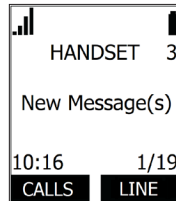

To listen to your messages:

1. From the handset Main Menu, with **Message** highlighted, press **SELECT**.

The Message screen appears.



2. Press **▼** to highlight the desired account and press **SELECT**.

The handset dials the voicemail access number.

3. Follow the voice prompts to listen to your messages.

Using the Directory

The handset has three lists of contacts. The **Local directory** is only available on your handset. The **Base directory** is usually maintained by your system administrator, and is available on all handsets. The **Blacklist** contains blocked numbers.

To view a directory:

1. From the handset Main Menu, press **▼** to scroll to **Directory** and press **SELECT**, or press **▲** when the phone is idle.

The Directory menu appears.

2. Press **▲** or **▼** to select the directory you wish to view, then press **SELECT**.

3. With **Review** selected, press **SELECT**.

4. Press **▼** or **▲** to browse through contacts.

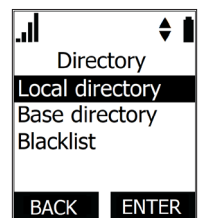

To call a contact:

When viewing a directory entry, you can call a contact in the following ways.

1. Dial the phone number in the entry:
 - a. Press **TYPE** to cycle through work, mobile, and other numbers.
 - b. Press **DIAL** to call the contact.
2. Revise the phone number to dial before calling:
 - a. Press **MENU**.
 - b. Press ▼ to scroll to **Edit dial** and press **SELECT**.
 - c. Edit the number as required, then press **DIAL** .



To search a directory:

1. From the handset Main Menu, press ▼ to scroll to **Directory** and press **SELECT**. The Directory menu appears.
2. Press ▲ or ▼ to select the directory to search, then press **SELECT**.
3. Press ▼ to scroll to **Search** and press **SELECT**.
4. Enter a name or number, then press **NEXT** .



To add a new entry:

1. From the handset Main Menu, press ▼ to scroll to **Directory** and press **SELECT**. The Directory menu appears.
2. Press ▲ or ▼ to select the directory to add a new entry to, then press **SELECT**.
3. Press ▼ to scroll to **Add new** and press **SELECT**.
4. Use the dial pad to enter the first name, last name, work, mobile, and other phone numbers. Press **NEXT** after entering each item.
5. Press **SELECT** to choose the ringer tone, then press **NEXT** .
6. Press **SELECT** to choose the dial line (account).
7. When you are done, press **SAVE** .



To edit an entry:

1. When viewing the directory entry you wish to edit, press **MENU**.
2. With **Edit** highlighted, press **SELECT**.
3. Press ▲ or ▼ to select an item to edit.
4. Use the dial pad to change the first name, last name, work, mobile, and other phone numbers. Press **BACKSP** to delete characters.
5. Press **SELECT** to change the ringer tone and dial line (account).
6. When you are done editing, press **SAVE** .

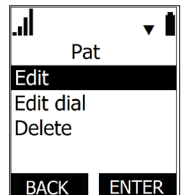

To delete an entry:

1. When viewing the directory entry you wish to delete, press **MENU**.
2. Press ▼ to scroll to **Delete** and press **SELECT**.
3. Press **YES** on the delete confirmation screen.

To delete all entries:

1. From the handset Main Menu, press ▼ to scroll to **Directory** and press **SELECT**. The Directory menu appears.
2. Press ▲ or ▼ to select the directory to delete, then press **SELECT**.
3. Press ▼ to scroll to **Delete all** and press **SELECT**.
4. Press **YES** on the delete all confirmation screen.



Using the Call History

The Call History contains lists of your missed, received, and dialed calls (you can also view dialed calls by pressing **REDIAL**). You can view, call and store list entries.

To view the Call History:

1. From the handset Main Menu, press ▼ to scroll to **Call History** and press **SELECT**, or press ▼ when the phone is idle. The Call History menu appears.
2. Press ▼ or ▲ to highlight the desired list and press **SELECT**.
3. With **Review** highlighted, press **SELECT**.
4. Press ▼ or ▲ to view entries.

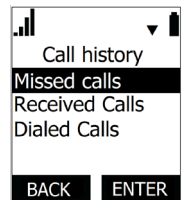

The Call History entry screen shows the time, date, name and number of the call, the number of entries in the folder, along with an icon indicating the type of call.



To call an entry:

When viewing a Call History entry, you can call the entry in the following ways.

1. Press **DIAL** to call the phone number in the entry.
2. Revise the phone number to dial before calling:
 - a. Press **MENU**.
 - b. With **Edit dial** highlighted, press **SELECT**.
 - c. Edit the number as required, then press **DIAL**.

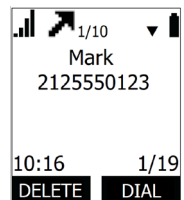

To save an entry to a directory:

1. Press **MENU** when viewing a Call History entry.
2. Press ▼ to scroll to **Save To** and press **SELECT**. Press ▲ or ▼ to select the directory to save to, then press **ENTER**.
3. Use the dial pad to enter the first name, last name, work, mobile, and other phone numbers. Press **NEXT** after entering each item.
4. Press **SELECT** to choose the ringer tone, then press **NEXT**.
5. Press **SELECT** to choose the dial line (account).
6. When you are done, press **SAVE** to return to Call History.

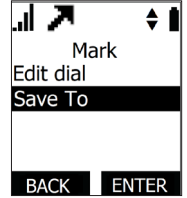

To delete entries:

1. To delete the entry you are viewing, press **DELETE**.
2. To delete all entries:
 - a. In the main Call History menu, press ▲ or ▼ to select the list you wish to delete, then press **ENTER**.
 - b. Press ▼ to scroll to **Delete all** and press **SELECT**.
 - c. On the delete all confirmation screen, press **SELECT** to delete all, or press **CANCEL**.

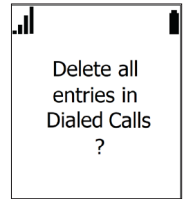

Using Speed Dial

The speed dial feature allows you to program up to 10 numbers that you dial frequently. To dial a speed dial number, press and hold the dial pad key that matches the speed dial entry number (for entry 10, press and hold **0**).

To program a Speed Dial number:

1. Press **MENU**.
2. Press ▼ to scroll to **Speed dial** and press **SELECT**.
3. Press ▼ or ▲ to select an empty slot, then press **SELECT**.



4. Use the dial pad to enter a name, and then press ▼.
5. Use the dial pad to enter a number, and then press ▼.
6. Press ◀ or ▶ to choose the dial line (account), and then press **SAVE** .

To edit existing Speed Dial entries:

1. Select the entry in the Speed Dial list then press **MENU/FUNC**.
2. Press ▼ or ▲ to select an item to edit.
3. Use the dial pad to change the name and number. Press **BACKSP** to delete characters.
4. Press ◀ or ▶ to change the dial line (account).
5. When you are done editing, press **SAVE** .

To delete existing Speed Dial entries:

1. Select the entry in the Speed Dial list, and then press **DELETE**.
2. Press **YES** on the delete confirmation screen.

Configuring the Handset

You can configure the phone using one of two methods:

1. The **Features** and **User settings** menus on the phone.
2. The WebUI, which you access using your Internet browser.

This section describes settings you can change using your handset. For information about settings you can change on the WebUI, see “WebUI” on page 58.

The system administrator can configure additional settings, including Network settings, Provisioning, and the PIN code by using the **Admin settings** menu. For more information about this menu, see the *VDP650 Administrator and Provisioning Manual*, available at businessphones.vtech.com.

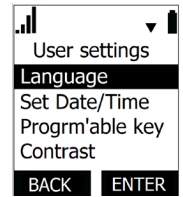
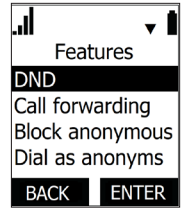

Setting do not disturb

When Do Not Disturb (DND) is on for an account, calls to that account will be rejected.

To turn DND on or off:

1. Press **MENU**.
2. Press **▼** to scroll to **Features** and press **SELECT**.
3. With **DND** highlighted, press **SELECT**.
4. Press **▲** or **▼** to select which account DND should apply to*, then press **SELECT**.
5. Press **▲** or **▼** to choose **On** or **Off**.
6. Press **SET** to save.

* Note that DND will apply to all handsets assigned the account.

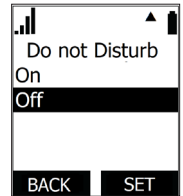

Setting call forwarding

Calls can be forwarded to another phone number always, only when busy, or after a set number of rings.

To set call forward:

1. Press **MENU**.
2. Press **▼** to scroll to **Features** and press **SELECT**.
3. Press **▼** to scroll to **Call forwarding** and press **SELECT**.
4. Press **▲** or **▼** to select which account Call forward should apply to*, then press **SELECT**.
5. Press **▲** or **▼** to choose the desired option:
 - Always
 - Busy
 - No answer

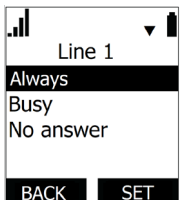

6. Press **SELECT**.
7. On the next screen, with **Set On/Off** highlighted, press **SELECT**.
8. Press **▲** or **▼** to choose **On** or **Off**, and press **SELECT**.
9. Press **▼** to scroll to **Phone number** and press **SELECT**.
10. Enter the number to which you would like to forward calls.
11. Press **BACKSP** to move the cursor back and delete the previous number.
12. Press **SAVE**.
13. If you selected **No answer** earlier:
 - a. Press **▼** to scroll to **No ans. delay**.
 - b. Press **▲** or **▼** to choose the number of rings between 1 and 10.
 - c. Press **SELECT**.

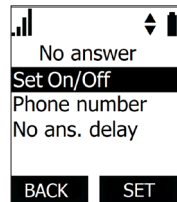

* Note that Call forward will apply to all handsets assigned the account.

Blocking anonymous calls

Calls without Caller ID information will be rejected and the handset will not ring.

To block anonymous callers:

1. Press **MENU**.
2. Press **▼** to scroll to **Features** and press **SELECT**.
3. Press **▼** to scroll to **Block anonymous** and press **SELECT**.
4. Press **▲** or **▼** to select which account Block anonymous should apply to*, then press **SELECT**.
5. Press **▲** or **▼** to choose **On** or **Off**.
6. Press **SET** to save.

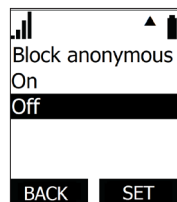

* Note that Block anonymous will apply to all handsets assigned the account.

Dialing anonymously

When this feature is enabled, your phone will make anonymous outgoing calls.

To dial as an anonymous caller:

1. Press **MENU**.
2. Press **▼** to scroll to **Features** and press **SELECT**.
3. Press **▼** to scroll to **Dial as anonyms** and press **SELECT**.
4. Press **▲** or **▼** to select which account Dial as anonymous should apply to*, then press **SELECT**.
5. Press **▲** or **▼** to choose **On** or **Off**.
6. Press **SET** to save.

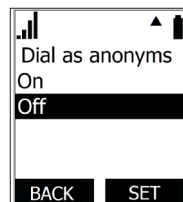

* Note that Dial as anonymous will apply to all handsets assigned the account.

Setting missed-call alerts

When missed-call alerts are enabled, an alert will display on the idle screen whenever you do not answer an incoming call.

To turn missed-call alerts on or off:

1. Press **MENU**.
2. Press ▼ to scroll to **Features** and press **SELECT**.
3. Press ▼ to scroll to **Miss call alert** and press **SELECT**.
4. Press ▲ or ▼ to choose **Show alert** or **Hide alert**.
5. Press **SET**.

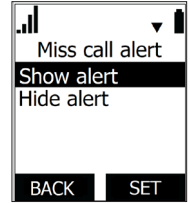

Setting call waiting

When call-waiting alerts are enabled, an alert will display on-screen whenever you receive an incoming call during an active call.

To turn call-waiting alerts on or off:

1. Press **MENU**.
2. Press ▼ to scroll to **Features** and press **SELECT**.
3. Press ▼ to scroll to **Call waiting** and press **SELECT**.
4. Press ▲ or ▼ to choose **Show alert** or **Hide alert**.
5. Press **SET**.



Viewing handset status

In the Status menu, you can view information on the LAN network your phone system is connected to, the registration status of your SIP accounts, or view the software version of your handset. You may need this information for troubleshooting purposes.

To view the Status menu:

1. Press **MENU**.
2. Press ▼ to scroll to **Status** and press **SELECT**.
3. Press ▼ to scroll to either **Network**, **Line**, or **Product Info**, and press **SELECT**.

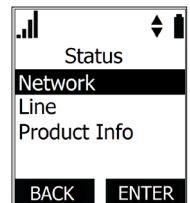

To view the software version of your phone:

1. From the **Status** menu, select **Product Info** and press **SELECT**.
2. With **Handset** highlighted, press **SELECT**.
3. Scroll down to view the software version.

Setting the language

1. Press **MENU**.
2. Press **▼** to scroll to **User settings** and press **SELECT**.
3. With **Language** highlighted, press **SELECT**.
4. Press **▲** or **▼** to choose the desired language.
5. Press **SET** to save.



Setting the date and time

1. Press **MENU**.
2. Press **▼** to scroll to **User settings** and press **SELECT**.
3. Press **▼** to scroll to **Set Date/Time** and press **SELECT**.
4. To set the date format:
 - a. With **Date format** highlighted, press **SELECT**.
 - b. Press **▲** or **▼** to choose **MM/DD/YY** or **DD/MM/YY**.
 - c. Press **SET**.
5. To set the time format:
 - a. Press **▼** to scroll to **Time format** and press **SELECT**.
 - b. Press **▲** or **▼** to choose **12 hour** or **24 hour**.
 - c. Press **SET**.
6. To set the date and time:
 - a. Press **▼** to scroll to **Date/time** and press **SELECT**.
 - b. Use the dial pad to enter the date. Press **BACK** if you enter an incorrect digit.
 - c. Press **NEXT**.
 - d. Use the dial pad to enter the time.
 - e. Press **SAVE**.

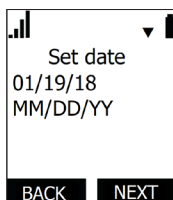
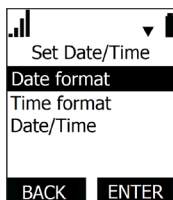

Setting the handset name

You can change the handset name from the default HANDSET.

To change the handset name:

1. Press **MENU**.
2. Press **▼** to scroll to **User settings** and press **SELECT**.
3. Press **▼** to scroll to **Phone rename** and press **SELECT**.
4. Press **BACKSP** to move the cursor back and delete the previous name.
5. Enter the new name using the dial pad.
6. Press **SET** when complete.



Configuring the programmable keys

You can configure the Programmable Keys on the handset.

To configure the line keys (L1-L4):

1. Press **MENU/FUNC**.
2. Press ▼ to highlight **User settings** and then press **SELECT**.
3. Press ▼ to highlight **Progrm'able key** and then press **SELECT**.
4. With **Line key** highlighted, press **SELECT**.
5. Press ▼ or ▲ to select a line key and then press **EDIT**.
6. Press **SELECT** to choose the Type of key.
For a list of available Types, see "Programmable Key Types" on page 53.
7. If the key has another setting (as indicated by ▼), press ▼ and then press **SELECT** to choose the Value or Account.
8. Press **SAVE**.
9. To configure another line key, go to step 5.

To configure the soft keys:

1. Press **MENU/FUNC**.
2. Press ▼ to highlight **User settings** and then press **SELECT**.
3. Press ▼ to highlight **Progrm'able key** and then press **SELECT**.
4. Press ▼ to highlight **Softkey** and then press **SELECT**.
5. Press ▼ or ▲ to select a soft key and then press **EDIT**.
6. Press **SELECT** to choose the Type of key.
For a list of available Types, see "Programmable Key Types" on page 53.
7. If the key has another setting (as indicated by ▼), press ▼ and then press **SELECT** to choose the Account.
8. Press **SAVE**.
9. To configure another soft key, go to step 5.

To configure the hard keys:

1. Press **MENU/FUNC**.
2. Press ▼ to highlight **User settings** and then press **SELECT**.
3. Press ▼ to highlight **Progrm'able key** and then press **SELECT**.
4. Press ▼ to highlight **Hardkey** and then press **SELECT**.
5. Press ▼ or ▲ to select a hard key and then press **EDIT**.

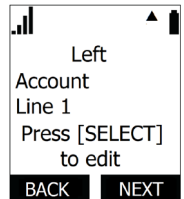
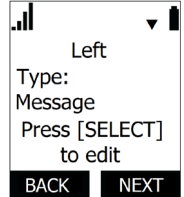
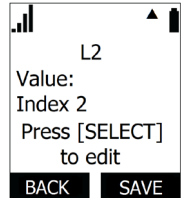
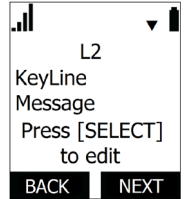
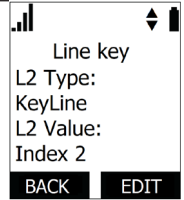

6. Press **SELECT** to choose the Type of key.
For a list of available Types, see “Programmable Key Types” below.
7. If the key has another setting (as indicated by ▼), press ▼ and then press **SELECT** to choose the Account.
8. Press **SAVE** .
9. To configure another hard key, go to step 5.

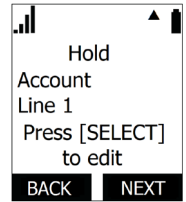

Programmable Key Types

You can assign functions to line keys (**L1**, **L2**, **L3**, **L4**), soft keys (located above the **L1** and **L2** keys), and hard keys (**HOLD**, **▲**, **▼**, **INTERCOM**, **MUTE**).

Keys can have identical functions, depending on the “Type” of key. For example, you can assign keys for Key System Emulation so that you can manage your own held calls and shared calls within the system. You can also assign several “Line”-type keys to Account 1 so that you can manage multiple calls on Account 1. For programmable key default settings, see “Programmable Key Types” on page 53.

Type	Description
N/A	Configures the key so it does not have a function. If you press the key, nothing will happen.
KeyLine*	Configures the key for Key System Emulation. You can manage your own held calls and shared calls within the system. The key LED will change according to call activity. Select the desired line index number.
Line*	Configures the key for accessing a line. You can make calls or answer calls by pressing these keys. The key LED will change according to call activity. Select the desired Account number.
Call list	Configures the key to access the Call List. You can then press the key to view the Call List.
Directory	Configures the key to access the Directory menu. You can then press the key to view the Directory menu.
Call History	Configures the key to access the Call History list. You can then press the key to view the Call History list.
Redial	Configures the key to access the Redial list. You can then press the key to view the Redial list.
Message	Configures the key to access the Message menu. You can then press the key to view the Message menu.
Do Not Disturb	Configures the key to turn Do Not Disturb on or off.

* This Type is only available for line keys (**L1** to **L4**).

Type	Description
Call Forward All	Configures the key to turn Call Forward All on or off. Select the line for which Call Forward All will apply. Ensure that you also configure Call Forward settings on the WebUI Call Settings page.
Call Forward Busy	Configures the key to turn Call Forward Busy on or off. Select the account for which Call Forward Busy will apply. Ensure that you also configure Call Forward settings on the WebUI Call Settings page.
Call Forward No Answer	Configures the key to turn Call Forward No Answer on or off. Select the account for which Call Forward No Answer will apply. Ensure that you also configure Call Forward settings on the WebUI Call Settings page.

Line key lights

The line key lights (**L1** to **L4**) indicate call status and other information.

Type	Light Activity	Description
KeyLine*	Steady GREEN	Shared Call operation: On a call or dialing; OR Shared call is active on your handset or another handset/ deskset
	Quickly flashing GREEN	Ringing incoming call
	Slowly flashing GREEN	Shared call is on hold on your handset or another handset/ deskset
Line	Steady GREEN	Private Call operation: On a call or dialing
	Quickly flashing GREEN	Ringing incoming call
	Slowly flashing GREEN	Held call
Do Not Disturb	Off	DND is off
	Steady GREEN	DND or DND All is on
Call forward	Off	Call forward All is off
	Steady GREEN	Call forward All is on

* For more information, see “Using Key System Emulation” on page 35.

Setting the screen contrast

You can change the contrast of text and graphics on the handset LCD.

To change the LCD text contrast:

1. Press **MENU**.
2. Press ▼ to scroll to **User settings** and press **SELECT**.
3. Press ▼ to scroll to **Contrast** and press **SELECT**.
4. Press ▼ or ▲ to choose a contrast level between 1 and 7.
5. Press **SET**.

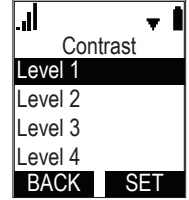

Backlight

You can set the deskset LCD backlight to be off when in idle, or set it to turn on or off continuously.

To set the LCD backlight:

1. Press **MENU**.
2. Press ▼ to highlight **User settings** and then press **SELECT**.
3. Press ▼ to highlight **LCD Backlight** and then press **SELECT**.
4. Press ▼ or ▲ to choose **Backlight Time**, **During idle** or **Being triggered***.
 - If you select **Backlight Time**, press ▼ or ▲ to choose the timeout period between 10 seconds and 60 seconds.
 - If you select **During idle** or **Being triggered**, press ▼ or ▲ to choose **On** or **Off**.
5. Press **SET** to save.

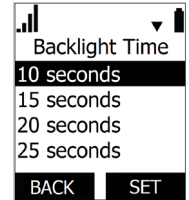
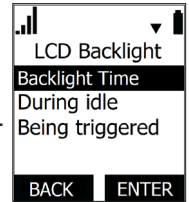

* Notes:

- If **During idle** is on and **Being triggered** is off, the LCD backlight always lights up.
- If **During idle** is off and **Being triggered** is on, the LCD backlight turns off after being idle for as long as the set timeout period.
- If **During idle** and **Being triggered** are both off, the LCD backlight is always off.

Setting the ringer tone and volume

1. Press **MENU**.
2. Press ▼ to scroll to **User settings** and press **SELECT**.
3. Press ▼ to scroll to **Ringers** and press **SELECT**.
4. To change the ringer volume:
 - a. Highlight **Ringer Volume** and press **SELECT**.
 - b. Press ▼ or ▲ to change the volume level as desired.
 - c. Press **SET** to save.
5. To change the ringer tone:
 - a. Press ▼ to scroll to **Ringer Tone** and press **SELECT**.
 - b. Press ▼ or ▲ to select an account, then press **ENTER**.
 - c. Press ▼ or ▲ to select a ringer tone.
 - d. Press **SELECT** to save.

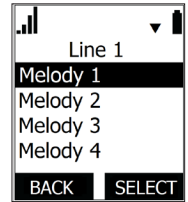
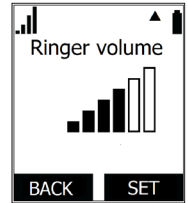

Turning low battery tone on or off

1. Press **MENU**.
2. Press ▼ to scroll to **User settings** and press **SELECT**.
3. Press ▼ to scroll to **Low batt tone** and press **SELECT**.
4. Press ▼ or ▲ to choose **On** or **Off**.
5. Press **SET** to save.

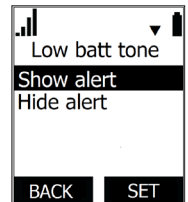

Turning link lost tone on or off

1. Press **MENU**.
2. Press ▼ to scroll to **User settings** and press **SELECT**.
3. Press ▼ to scroll to **Link lost tone** and press **SELECT**.
4. Press ▼ or ▲ to choose **On** or **Off**.
5. Press **SET** to save.

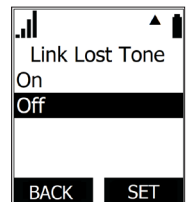

Turning key tones on or off

1. Press **MENU**.
2. Press ▼ to scroll to **User settings** and press **SELECT**.
3. Press ▼ to scroll to **Key Tone** and press **SELECT**.
4. Press ▼ or ▲ to choose **On** or **Off**.
5. Press **SET** to save.

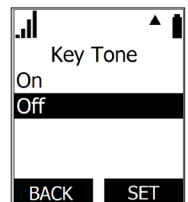

Registering or deregistering your handset

You can register or deregister your handset using the handset menu. Follow the instructions in “Registering the handset to the base station” on page 23 and “Deregistering the handset” on page 24.

WebUI

Using the WebUI

Use an Internet browser to access the Web User Interface (WebUI) that resides on your base station. After you log on to the WebUI, you can configure the following features:

- Call Settings
- User Preferences
- Base Directory
- Blacklist
- User Password

The WebUI also has a System Status and Handset Status page, where you can view network status and registration information about your handset.

To access the WebUI:

1. Ensure that your computer is connected to the same network as your base station.
2. Find the IP address of your base station:
 - a. When the phone is idle, press **MENU**.
 - b. Press **▼** to highlight **Status**, and then press **SELECT**. The Status menu appears:

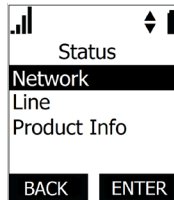

- c. On the Status menu, ensure that **Network** is highlighted, and then press **SELECT**. The Network screen appears:

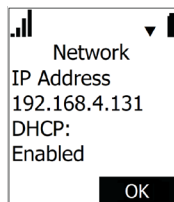

- d. On the Network screen, note the IP Address.
3. On your computer, open an Internet browser. Depending on your browser, some of the pages presented here may look different and have different controls.

4. Type the phone IP address in the browser address bar and press **ENTER** on your computer keyboard:



A Login window appears.

5. Under **User Name**, enter **user**.
6. Under **Password**, enter **user**, or your own password, if you have created one. You can create or change a password after you log on.
7. Click **Log In / OK**. The WebUI appears.

A screenshot of the WebUI STATUS page. The page has a dark blue header with the word "STATUS" in white. Below the header is a navigation bar with four tabs: "STATUS", "SYSTEM", "CONTACTS", and "SERVICING". The "STATUS" tab is selected. On the left side, there is a vertical blue sidebar with two sections: "System Status" and "Handset Status". The main content area is white and contains the following information:

General

Model:	VDP650
Serial Number:	07900002999
MAC Address:	14:AE:DB:2A:40:1D
Link Status:	Connected
Boot Version:	1.13
Software Version:	2.10.37.9c8e
V-Series:	2.10.37.9c8e
Hardware Version:	HW1.1
EMC Version:	0
Network Time Settings:	us.pool.ntp.org

Account Status

Account 1:	Registered
Account 2:	Registered
Account 3:	Not Registered
Account 4:	Not Registered
Account 5:	Not Registered
Account 6:	Not Registered
Account 7:	Not Registered
Account 8:	Not Registered

Click topics from the navigation bar at the top of the page, and then click the desired setting on the left side of the WebUI to see the page for that setting. You view and change settings in two different types of fields: drop-down lists and entry fields into which you type information. For your security, the WebUI times out after 10 minutes, so if it is idle for that time, you must log on again.

The remaining procedures in this section assume that you have already logged on to the WebUI.

System Status

The System Status page shows:

- **General** information about your phone, including model, MAC address, and firmware version.
- **Account Status** information about your SIP account registration.
- **IPv4** and **IPv6** network information regarding your phone's network address and network connection.

The System Status page has no settings that you can change. You may need some of the status information for troubleshooting purposes.

STATUS	STATUS	SYSTEM	CONTACTS	SERVICING
System Status				
Handset Status				
	General			
	Model:	VDP650		
	Serial Number:	07900002999		
	MAC Address:	14:AE:DB:2A:40:1D		
	Link Status:	Connected		
	Boot Version:	1.13		
	Software Version:	2.10.37.9c8e		
	V-Series:	2.10.37.9c8e		
	Hardware Version:	HW1.1		
	EMC Version:	0		
	Network Time Settings:	us.pool.ntp.org		
	Account Status			
	Account 1:	Registered		
	Account 2:	Registered		
	Account 3:	Not Registered		
	Account 4:	Not Registered		
	Account 5:	Not Registered		
	Account 6:	Not Registered		
	Account 7:	Not Registered		
	Account 8:	Not Registered		
	IPv4			
	IP Mode:	dhcp		
	IP Address:	10.88.50.107		
	Subnet Mask:	255.255.0.0		
	Gateway:	10.88.3.149		
	Primary DNS:	10.88.162.10		
	Secondary DNS:	10.88.162.6		
	VPN:	Disabled		
	IPv6			
	IP Mode:	disable		
	IP Address:	::		
	Prefix:	0		
	Gateway:	fe80::217:c5ff:fe42:1c7c		
	Primary DNS:			
	Secondary DNS:			

Handset Status

The Handset Status page shows registration information for your handsets.

STATUS	SYSTEM	CONTACTS	SERVICING
System Status	Handset Status		
Handset Status	Name	Registration Status	
	1:	HANSET	Not Registered
	2:	DESKSET	Registered
	3:	HANSET	Registered
	4:	HANSET	Not Registered
	5:	HANSET	Not Registered
	6:	HANSET	Not Registered
	7:	HANSET	Not Registered
	8:	HANSET	Not Registered
	9:	HANSET	Not Registered
	10:	HANSET	Not Registered

The Handset Status page has no settings that you can change. You may need some of the status information for troubleshooting purposes.

Call Settings

To view the call settings, click **SYSTEM** in the WebUI header, and then click **Call Settings** in the sidebar. You can configure call settings for each account that is available to your phone. Click **Account 1**, **Account 2**, and so on to select the call settings page for the desired account.

Call Settings include Do Not Disturb and Call Forward settings. You can also set Do Not Disturb and Call Forward using the handset. See “Configuring the Handset” on page 48.

When you have finished changing settings on this page, click **Save** to save them.

SYSTEM	STATUS	SYSTEM	CONTACTS	SERVICING
Call Settings	SYSTEM CALL SETTINGS 1			
Account 1	General Call Settings			
Account 2	<input type="checkbox"/> Anonymous Call Reject			
Account 3	<input type="checkbox"/> Enable Anonymous Call			
Account 4	Do Not Disturb			
Account 5	<input type="checkbox"/> Enable DND			
Account 6	Call Forward			
Account 7	<input type="checkbox"/> Enable Call Forward Always			
Account 8	Target Number: <input type="text"/>			
User Preferences	<input type="checkbox"/> Enable Call Forward Busy			
	Target Number: <input type="text"/>			
	<input type="checkbox"/> Enable Call Forward No Answer			
	Target Number: <input type="text" value="2913"/>			
	Delay: <input type="text" value="1 ring"/>			
	<input type="button" value="Save"/>			

General Call Settings

Setting	Description
Anonymous Call Reject	Select to block incoming calls that have no caller ID.
Enable Anonymous Call	Select to make outgoing calls that remove your own caller ID information.

Do Not Disturb Settings

Setting	Description
Enable DND	Turns Do Not Disturb on or off.

Call Forward Settings

Setting	Description
Enable Call Forward Always	Select to enable call forwarding for all calls on that account.
Target Number	Enter a number to which all calls will be forwarded.
Enable Call Forward Busy	Select to enable call forwarding for calls when you are on another call on that account.
Target Number	Enter a number to which calls will be forwarded when the account is busy.
Enable Call Forward No Answer	Select to enable call forwarding for unanswered calls on that account.
Target Number	Enter a number to which unanswered calls will be forwarded.
Delay	Select the number of rings before unanswered calls are forwarded. Range: 1 to 10 rings Default: 6 rings

User Preferences

On the User Preferences page, you can configure the WebUI language. After changing the setting on this page, click **Save** to save.

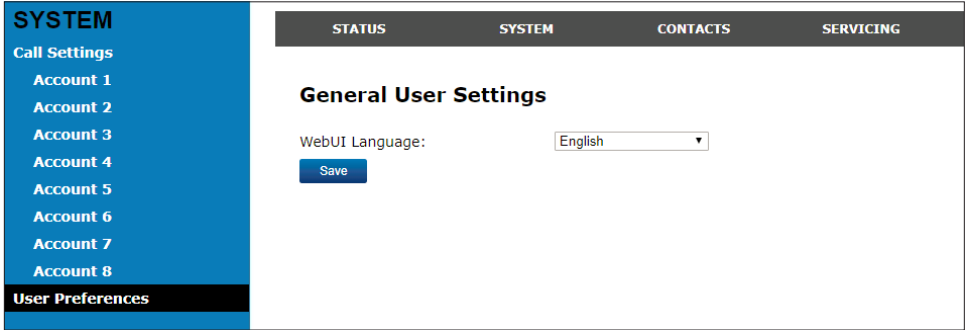

The screenshot shows a web interface with a blue sidebar on the left containing a menu with items like 'Call Settings', 'Account 1' through 'Account 8', and 'User Preferences'. The main content area has a dark header with tabs for 'STATUS', 'SYSTEM', 'CONTACTS', and 'SERVICING'. Below the header, the 'General User Settings' section is visible, featuring a 'WebUI Language:' label, a dropdown menu currently set to 'English', and a blue 'Save' button.

General User Settings

Setting	Description	Range	Default
WebUI Language	Sets the language that appears on the WebUI.	Any language supported by your phone. For example, English, French, Spanish, etc.	English

Base Directory

To view the base directory, click **CONTACTS** in the WebUI header, and then click **Base directory** in the sidebar.

On the Base directory page, you can manage your base directory entries. You can sort, edit, delete, and add contact information for up to 1,000 entries. The page also allows you to export your phone's base directory or import a base directory file. The export function lets you back up your contacts to your computer.

The Base directory lists entries across several pages. Click **Next**, **First**, **Last**, or a page number to view the desired page of entries.

Note: You can also use the phone menu to manage your base directory entries. For more information, see "Using the Directory" on page 43.

CONTACTS

Base Directory
Blacklist
LDAP
Remote XML

STATUS SYSTEM NETWORK CONTACTS SERVICING

Base Directory

Select All [Sort By Last Name](#)

Total: 20	First Name	Last Name	Ringer Tone	Work	Mobile	Other	Account	
<input type="checkbox"/>	Angela	Martin	0			7325550118	1	Edit
<input type="checkbox"/>	Bronwyn	McDonald	0			2325550140	1	Edit
<input type="checkbox"/>	Charlie	Johnson	0			5550198	1	Edit
<input type="checkbox"/>	Dale	Appleton	0	6045550135			1	Edit
<input type="checkbox"/>	David	Carter	3	2325550177		2325550194	2	Edit
<input type="checkbox"/>	Davis	Swerdlow	0	2325550172			1	Edit
<input type="checkbox"/>	Elkhart	Taxi	0	6045550155			1	Edit
<input type="checkbox"/>	Graham	Ball	0	2325550176			1	Edit
<input type="checkbox"/>	Kathryn	Dolphy	0	6045550195			1	Edit
<input type="checkbox"/>	Linda	Miller	0	6045550117			2	Edit
<input type="checkbox"/>	Lydia	Braithwaite	0			2325550157	1	Edit
<input type="checkbox"/>	Martin	Meyers	0			2325550122	1	Edit
<input type="checkbox"/>	Mary	Williams	0	604555015	6045550146		1	Edit
<input type="checkbox"/>	Richard	Serling	0	6045550141	7875550181		2	Edit
<input type="checkbox"/>	Robert	Brown	2	6045550105			2	Edit
<input type="checkbox"/>	Sandro	Voss	0			2325550149	1	Edit
<input type="checkbox"/>	Stefan	Wheeler	0	2325550161			1	Edit
<input type="checkbox"/>	Susan	Balance	0	6045550170			1	Edit
<input type="checkbox"/>	Terry	Ng	0	2325550187			1	Edit
<input type="checkbox"/>	Ursula	Baldwin	0			6045550166	1	Edit

First 1 Last

[Delete Selected Entries](#) [Add New Entry](#)
[Clear Directory](#)

Import Base Directory

No file chosen [Choose File](#)
[Import XML](#)
 First line is header, skip [Import CSV](#)

Export Base Directory

[Export XML](#)
[Export CSV](#)

Base directory

Click	To...
Sort By Last Name	Sort the list by last name.
Sort By First Name	Sort the list by first name.
Edit	Edit information for an entry.
Last	View the last page of entries.
Next	View the next page of entries.
Delete Selected Entries	Delete selected entries from the directory. Click Select All to select every entry on the page you are viewing.
Add New Entry	Add a new directory entry.
Clear Directory	Delete all Directory entries

To add a new directory entry:

1. Click **Add New Entry**.

The **Create Local Directory Entry** page appears.

2. Enter the required information. At minimum, a first and last name are required.

Setting	Description	Range	Default
First Name	Enter the appropriate names in these fields.	N/A	N/A
Last Name			
Ringer Tone	Sets a unique ringer tone for calls from this directory entry.	Auto, Tone 1–10	Auto
Account	Sets the account used when you dial this directory entry.	Default Account, Account 1–Account 8	Default Account
Work Number	Enter the appropriate numbers in these fields.	N/A	N/A
Mobile Number			
Other Number			

3. Click **Save**.

To edit a directory entry:

1. Click Edit for the entry you want to edit.

The **Edit Local Directory Entry** page appears.

STATUS	SYSTEM	CONTACTS	SERVICING
Edit Local Directory Entry			
First Name:	<input type="text" value="John"/>		
Last Name:	<input type="text" value="Smith"/>		
Ringer Tone:	<input type="text" value="Auto"/>		
Account:	<input type="text" value="Account 1"/>		
Work Number:	<input type="text" value="5551231234"/>		
Mobile Number:	<input type="text" value="5558729863"/>		
Other Number:	<input type="text" value="5556126549"/>		
<input type="button" value="Save"/>			

2. Edit or add the desired information.
3. Click **Save**.

Import Base directory

You can import an existing base directory file. Importing a directory file replaces all your previous base directory entries. After importing a directory file, you can add, edit, or delete entries as desired.

Note: Directory files are .xml or .csv files containing contacts and contact information. For more information about creating or editing a directory file, consult your system administrator.

To import a base directory file:

1. Click **Choose File**.
2. In the **Choose File to Upload** window, navigate to the directory file.
3. Click the file, and then click **Open**.
4. If you are importing an XML file, click **Import XML**.
5. If you are importing a comma-separated value (CSV) file:
 - a. If the first line of the CSV file is a header line, click the **First line is header, skip** checkbox.
 - b. Click **Import CSV**.

Export Base directory

You can export the directory and save it as an .xml file on your computer.

To export the base directory:

1. Click **Export XML** or **Export CSV**.
2. If prompted by your browser, save the file to the desired location on your computer.

Blacklist

To view the Blacklist, click **CONTACTS** in the WebUI header, and then click **Blacklist** in the sidebar.

The Blacklist directory is identical to the Base directory, except that you cannot configure an incoming ringer tone.

Remote XML

On the Remote XML page, you can configure up to three server-hosted Remote XML directories to appear on the Directory menu of your deskset.

CONTACTS	STATUS	SYSTEM	CONTACTS	SERVICING
Base Directory	Remote XML Directories			
Blacklist	ID	Name	Remote XML URI	Enable Incoming/Outgoing Call Lookup
Remote XML	1	<input type="text"/>	<input type="text"/>	<input type="checkbox"/>
	2	<input type="text"/>	<input type="text"/>	<input type="checkbox"/>
	3	<input type="text"/>	<input type="text"/>	<input type="checkbox"/>
	<input type="button" value="Save"/>			

For more information about configuring Remote XML directories, see the *VDP650 Administrator and Provisioning Manual*.

Security

On the Security page, you can change the User Password that you use to access the WebUI.

SERVICING	STATUS	SYSTEM	CONTACTS	SERVICING
Security	Passwords			
	User Password			
	Enter Old Password:	<input type="text"/>		
	Enter New Password:	<input type="text"/>		
	Re-enter New Password:	<input type="text"/>		
	<input type="button" value="Save"/>			

After changing your password, click **Save**.

Troubleshooting

If you have difficulty with your handset, please try the suggestions below. For customer service, visit our website at businessphones.vtech.com or call **1 (888) 370-2006**.

General issues

Handset does not work at all (LCD is black)

- Confirm the battery is installed and charged correctly.
- Place the handset into its charger. Ensure the charger is securely plugged into an outlet not controlled by a wall switch.
- If the battery is completely depleted, it can take up to 10 minutes to charge the battery before the low battery icon displays on screen.

My caller ID isn't working.

- Caller ID is a subscription service. Your telephone service provider may require subscription to this service for this feature to work.
- The caller must be calling from an area that supports caller ID.
- Both your telephone service provider and your caller's service provider must use caller ID compatible equipment.

Handset registration is not working

- Place the handset in the charger for a few seconds, remove it and repeat the registration procedure.
- Ensure the handset is within range of the base station.

Cannot make external calls

- Check if your SIP account is registered (Press **MENU** → **Status** → **Line** and select an account. Check that the status reads **Registered**).
- You might be out of range of the base station. Try moving closer. If you see an idle screen with no alerts, then your handset is successfully communicating with the base station.

Handset does not receive incoming calls

- Ensure that **Do Not Disturb** and **Call Forward All** are turned off.
- Check if your SIP account is registered (Press **MENU** → **Status** → **Line** and select an account. Check that the status reads **Registered**).
- You might be out of range of the base station. Try moving closer.

Cannot locate handset using base station

- The handset may not be registered.
- If the handset battery is dead or the handset is out of range, the locator tone will not sound.

Poor audio quality. Speech is cutting out.

- You may be close to being out of range of the base station. Try moving closer.
- Other electronic products can cause interference with your handset. Try installing the base station far away from devices such as TVs, microwaves, or other cordless devices, including other handsets.
- If the problem persists, contact your system administrator.

Technical Specifications

RF frequency band	1921.536–1928.448 MHz
Channels	5
Operating temperature	32–104 °F (0–40 °C)
Power requirements	Base: 5.0 Vdc @ 800 mA Handset charger: 6.0 Vdc @ 100 mA Handset: 2.4 V 550 mAh, Ni-MH battery pack
Power over Ethernet	IEEE 802.3at supported, class 2
Ethernet network port	10/100 Mbps RJ-45 port

Special characters

Entering special characters

When entering text using the dial pad, the following special characters are available. Press the 1, 0, or pound sign (#) keys to enter special characters.

Key	Characters
1	~ ^ ` % ! & - _ + = 1
0	0 : ; , ? . @ * 0
#	() [] { } < > / \ #

Press star (✳) to switch between uppercase and lowercase/European characters.

Maintenance

Taking care of your telephone

- Your base station and cordless handset contain sophisticated electronic parts, so you must treat them with care.
- Avoid rough treatment.
- Place the handset down gently.
- Save the original packing materials to protect your products if you ever need to ship them.

Avoid water

- You can damage your cordless telephone if it gets wet. Do not use the handset in the rain, or handle it with wet hands. Do not install the base station and handset near a sink, bathtub or shower.

Electrical storms

- Electrical storms can sometimes cause power surges harmful to electronic equipment. For your own safety, take caution when using electric appliances during storms.

Cleaning your telephone

- Your products have a durable plastic casing that should retain its luster for many years. Clean it only with a soft cloth slightly dampened with water or a mild soap.
- Do not use excess water or cleaning solvents of any kind.

Remember that electrical appliances can cause serious injury if used when you are wet or standing in water. If the telephone base should fall into water, **DO NOT RETRIEVE IT UNTIL YOU UNPLUG THE POWER CORD FROM THE WALL**, then pull the unit out by the unplugged cord.

Deregistering the handset

Before using the handset with a different base station, you must deregister the handset from the base station to which it is currently registered.

GPL License Information

GPL code requests

Portions of the software associated with this product are open source, and fall within the scope of the GNU General Public License (GPL). Accordingly, those portions of code are available to the public, consistent with the requirements of the GPL, in either source code format or object code format, depending upon the nature of the code at issue. If you would like to exercise your right to receive the available code, please send a written request for the available code along with a cashier's check, payable to VTech Communications, Inc., in the amount of \$15.00 (U.S.\$) to:

VTech Communications, Inc.,
9590 SW Gemini Drive, Suite 120
Beaverton OR 97008

ATTN: Information Technology Group—VDP650 GPL code request

If your request does not fully comply with the foregoing requirements, VTech reserves the right to reject your request. Further, by requesting and receiving the available code, you release VTech, its affiliates, and its and their officers, directors, employees, and representatives ("VTech Parties") from any liability or responsibility relating to such code, and you acknowledge that the VTech Parties make no representations with respect to the origin, accuracy, usability, or usefulness of such code, and the VTech Parties have no responsibility to you whatsoever concerning the code, including without limitation any responsibility to provide explanation, support, upgrade, or any communication whatsoever. Your review or use of the available code is at your sole risk and responsibility.

VTECH COMMUNICATIONS LTD.

A member of THE VTECH GROUP OF COMPANIES.

Distributed in the U.S.A. by VTech Communications Inc., Beaverton, Oregon 97008.

VTech is a registered trademark of VTech Holdings Limited.

ErisTerminal® is a registered trademark of VTech Communications Inc.

Specifications are subject to change without notice.

Copyright © 2018 for VTECH COMMUNICATIONS LTD. All rights reserved.

Version 4, 04/18