

8190 SIP Classroom Speaker Firmware Version 1.7.3

User Guide

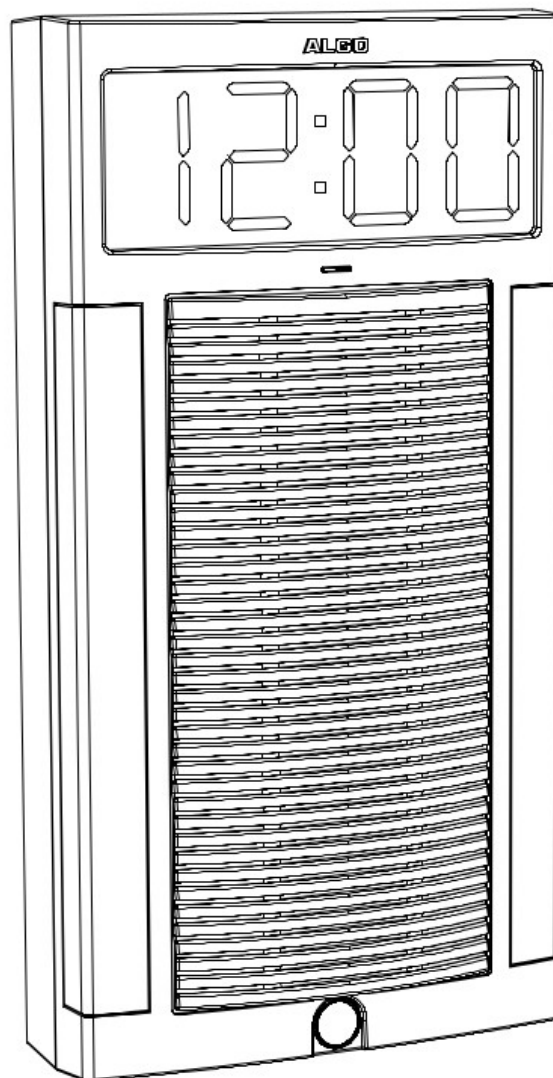

Table of Contents

IMPORTANT SAFETY INFORMATION.....	4
OVERVIEW.....	6
Introduction.....	6
Key Features.....	6
Reset Button.....	8
SETUP AND INSTALLATION.....	9
Getting Started - Quick Install & Test.....	9
Wall Mounting.....	10
Programming and Configuration.....	10
Inputs/Outputs.....	11
FEATURES.....	12
SIP Paging: One 8190.....	12
SIP Ring Event.....	12
Multicast Overview.....	12
SIP Paging: Multiple 8190s (Using Multicast).....	13
SIP Paging: Multiple Speakers (Using Individual SIP extensions).....	13
SIP Activated Notification Alerts.....	14
Background Music Streaming.....	14
Polycom™ Group Paging.....	14
TLS for SIP Signaling and Provisioning.....	15
WEB INTERFACE BASIC SETTINGS.....	18
Web Interface Login.....	18
Status.....	18
Basic Settings Tab – SIP.....	18
Basic Settings Tab – Features.....	20
Basic Settings Tab – Clock.....	22
Basic Settings Tab – Multicast.....	22
Basic Settings Tab – Multicast (Slave Settings).....	23
WEB INTERFACE ADDITIONAL FEATURES.....	25
Additional Features Tab – Input/Output.....	25
Additional Features Tab – Emergency Alerts.....	29
Additional Features Tab – More Ring Extensions.....	29
WEB INTERFACE ADVANCED SETTINGS.....	30
Advanced Settings Tab – Network.....	30
Advanced Settings Tab – Admin.....	32
Advanced Settings Tab – Time.....	35
Advanced Settings Tab – Provisioning.....	36
Advanced Settings Tab – File Manager.....	38
Advanced Settings Tab – Advanced Audio.....	39
Advanced Settings Tab – Advanced SIP.....	40
Advanced Settings Tab – Advanced Multicast.....	42
WEB INTERFACE SYSTEM.....	44
System Tab – Maintenance.....	44
System Tab – System Log.....	45

WIRING CONNECTIONS.....	46
Network Connection.....	46
Connecting Input Devices.....	46
Blue LED Indicator.....	47
SPECIFICATIONS.....	48
FCC COMPLIANCE STATEMENT.....	50

Important Safety Information

Important Safety Information

This product is powered by a certified limited power source (LPS), Power over Ethernet (PoE); through CAT5 or CAT6 connection wiring to an IEEE 802.3at PoE+ or 802.3af compliant network PoE switch. The product is intended for installation indoors. All wiring connections to the product must be in the same building. If the product is installed beyond the building perimeter or used in an inter-building application, the wiring connections must be protected against overvoltage/transient. Algo recommends that this product is installed by a qualified electrician.

If you are unable to understand the English language safety information then please contact Algo by email for assistance before attempting an installation support@algosolutions.com.

Consignes de Sécurité Importantes

Ce produit est alimenté par une source d'alimentation limitée certifiée (alimentation par Ethernet); des câbles de catégorie 5 et 6 joignent un commutateur réseau à alimentation par Ethernet homologué IEEE 802.3at PoE+ or 802.3af. Le produit est conçu pour être installé à l'intérieur. Tout le câblage rattaché au produit doit se trouver dans le même édifice. Si le produit est installé au-delà du périmètre de l'édifice ou utilisé pour plusieurs édifices, le câblage doit être protégé des surtensions transitoires. Algo recommande qu'un électricien qualifié se charge de l'installation de ce produit.

Si vous ne pouvez comprendre les consignes de sécurité en anglais, veuillez communiquer avec Algo par courriel avant d'entreprendre l'installation au support@algosolutions.com.

Información de Seguridad Importante

Este producto funciona con una fuente de alimentación limitada (Limited Power Source, LPS) certificada, Alimentación a través de Ethernet (Power over Ethernet, PoE); mediante un cable de conexión CAT5 o CAT6 a un conmutador de red con PoE en cumplimiento con IEEE 802.3at PoE+ or 802.3af. El producto se debe instalar en lugares cerrados. Todas las conexiones cableadas al producto deben estar en el mismo edificio. Si el producto se instala fuera del perímetro del edificio o se utiliza en una aplicación en varios edificios, las conexiones cableadas se deben proteger contra sobretensión o corriente transitoria. Algo recomienda que la instalación de este producto la realice un electricista calificado.

Si usted no puede comprender la información de seguridad en inglés, comuníquese con Algo por correo electrónico para obtener asistencia antes de intentar instalarlo: support@algosolutions.com.

Wichtige Sicherheitsinformationen

Dieses Produkt wird durch eine zertifizierte Stromquelle mit begrenzter Leistung (LPS – Limited Power Source) betrieben. Die Stromversorgung erfolgt über Ethernet (PoE – Power over Ethernet). Dies geschieht durch eine Cat-5-Verbindung oder eine Cat-6-Verbindung zu einer IEEE 802.3at PoE+ or 802.3af-konformen Ethernet-Netzwerkweiche. Das Produkt wurde konzipiert für die Installation innerhalb eines Gebäudes. Alle Kabelverbindungen zum Produkt müssen im selben Gebäude bestehen. Wenn das Produkt jenseits des Gebäudes oder für mehrere Gebäude genutzt wird, müssen die Kabelverbindungen vor Überspannung und Spannungssprüngen geschützt werden. Algo empfiehlt das Produkt von einem qualifizierten Elektriker installieren zu lassenv.

Sollten Sie die englischen Sicherheitsinformationen nicht verstehen, kontaktieren Sie bitte Algo per Email bevor Sie mit der Installation beginnen, um Unterstützung zu erhalten.

Algo kann unter der folgenden E-Mail-Adresse erreicht werden:

support@algosolutions.com.

安全须知

本产品由认证的受限电源（LPS），以太网供电（PoE），通过 CAT5 或 CAT6 线路联接至 IEEE 802.3at PoE+ or 802.3af 兼容的 PoE 网络交换机供电。本产品适用于室内或建筑物周边安装。所有联接本产品的线路必须源自同一建筑物。本产品如需用于超出建筑物周边范围或跨建筑物的安装，线路联接部分必须有过压和瞬态保护。Algo 建议本产品由专业电工安装。

如果您对理解英文版安全须知有问题，安装前请通过电子邮件和 Algo 联系，support@algosolutions.com。

EMERGENCY COMMUNICATION

If used in an emergency communication application, the 8190 SIP Classroom Speaker should be routinely tested. SNMP supervision is recommended for assurance of proper operation. Contact Algo for other methods of operational assurance.

DRY INDOOR LOCATION ONLY

The 8190 SIP Classroom Speaker is intended for dry indoor locations only. For outdoor locations Algo offers weatherproof speakers and strobe lights.

CAT5 or CAT6 connection wiring to an IEEE 802.3at PoE+ or 802.3af compliant network PoE switch must not leave the building perimeter without adequate lightning protection.

No wiring connected to the 8190 SIP Classroom Speaker may leave the building perimeter without adequate lightning protection.

Overview

Introduction

The 8190 SIP Classroom Speaker is a SIP compliant & multicast capable IP speaker designed for education but suitable for any application that requires crisp clear voice paging, loud ringing, and alert/notification with a high visibility clock. The 8190 can be integrated with any Communication Server (hosted or enterprise) that supports 3rd party SIP endpoints or multicast.

Instead of one speaker, the 8190 uses a multi-speaker line array for improved sound distribution in classrooms. Controlled dispersion in the vertical axis reduces reflections from floor and ceiling and provides more consistent direct sound levels for listeners at different distances from the speaker.

The 8190's feature set supporting 50 SIP extensions provides near infinite zoning capabilities, and 10 SIP extensions activating audio wav files from memory enable loud ringing, informational and emergency notification.

For voice paging, the 8190 is assigned a Page extension. When this SIP extension is called, the 8190 will auto-answer and play the caller's voice announcement over the speaker. The 8190 supports G.722 wideband HD Voice for enhanced intelligibility and clarity.

For loud ringing a separate Page extension can be assigned. When this SIP extension is called the 8190 will play a WAV file (tone, announcement, etc.) over the speaker. Several ringtones are included in the 8190 and custom WAV files may also be uploaded (e.g. safety, security, emergency alerts).

Consistent with other Algo IP Speakers, the 8190 includes a microphone for monitoring and adapting to ambient noise levels. This means voice paging and bell tones are always heard but never too loud. The microphone can also be enabled for hands free talkback.

Unlike other Algo IP Speakers, the 8190 has an integrated digital clock, integrated call button, and entrance security door control capability.

The 8190 is configured using central provisioning features, or by accessing a web interface using browsers such as Google Chrome, Firefox, or Internet Explorer.

Key Features

SIP Extensions

The 8190 connects to an on-premise or hosted communication server in the same way as a SIP telephone. To register the 8190 with the server requires the following information:

1. IP address (e.g. 192.168.1.1) or domain name (e.g. myserver.com) of the SIP Server
2. SIP extension (e.g. 3790)

3. Authentication ID
4. Password

The 8190 supports two SIP extensions which behave differently – **RING** and **PAGE**. One or both may be used depending on the application. If the RING extension is called the 8190 will not answer. Instead, it will play the selected WAV file until the ringing stops. Typically the RING extension is programmed as part of a hunt group so that it receives a ring signal simultaneously with one or more phones to function as a loud ringer in noisy or large areas.

If the PAGE extension is called, the 8190 will answer and allow paging over its internal speaker. When the 8190 answers it will play a configurable tone to the caller so they know when they can begin speaking. The same tone is also played over the speaker before the announcement. If Paging to a single 8190, talkback may be enabled using the integrated microphone. The audio direction is determined by the speech activity of the caller.

Speaker Array Technology

The 8190 uses a multi-speaker line array for improved sound distribution in classrooms. Controlled dispersion in the vertical axis reduces reflections from floor and ceiling and provides more consistent direct sound levels for listeners at different distances from the speaker. Wideband G.722 HD codec support provides improved speech intelligibility for voice paging and audio notification.

Multicasting

Allows multiple units to simultaneously play Ring or Page audio. 8190 can be configured as a multicast 'Slave' device to receive audio stream from a multicast 'Master' device. Any number/combination of Algo IP speaker, paging adapter, or strobe endpoint can be configured as multicast 'Slaves'. This feature provides scalability without requiring each endpoint Slave to be registered with a SIP extension.

Polycom™ Group Paging

The 8190 support Polycom Group Paging. The 8190 can be added to a Polycom Group Page so that voice paging is heard over Polycom telephone speakers and overhead paging simultaneously.

Ambient Noise Compensation

The 8190's can automatically adjust loud ring and paging volume to compensate for background ambient noise. If 'Ambient Noise Compensation' is enabled, the alert volume will get louder or quieter by the same dB level as the ambient noise measured just prior to the alert.

Configuration & Provisioning

Configuration can be done through a web interface control panel or by using the program buttons on the back of the unit. Central provisioning may also be used to allow units to be

pre-configured for a specific server prior to deployment in the field. Configuration files are automatically downloaded from a server (via TFTP, FTP, HTTP, HTTPS) using DHCP.

Reset Button

A recessed reset button (RST) on the back can be used to reset the 8190 SIP Classroom Speaker at time of power up. To reset, reboot or power cycle the 8190. Wait until the blue LED flashes and then press and hold the reset button until the blue LED begins a double flash pattern. Release the reset button and allow the unit to complete its boot process. **Do not press the reset button until the blue LED begins flashing.**

A reset will set all configuration options to factory default including the password.

Once booting has completed, pressing the reset button will cause the speaker to announce its IP address over the speaker.

Setup and Installation

Getting Started - Quick Install & Test



This guide provides important safety information which should be read thoroughly before permanently installing the speaker.

1. Connect the 8190 SIP Classroom Speaker to an IEEE 802.3at PoE+ or 802.3af compliant PoE network switch. The blue light at the top will remain on until boot up is completed – about 30 seconds.
2. After the blue LED turns off and you hear a tone, press the reset switch (RST) button on the back of the unit to hear the IP address over the speaker. The IP address may also be discovered by downloading the Algo Locator Tool to find Algo devices on your network: www.algosolutions.com/locator
3. Mount the speaker per the instructions in the next section
4. Access the 8190 web page by entering the IP address into a browser (Chrome, Firefox etc.) and login using the default password: **algo**
5. Enter the IP address for the SIP server into the SIP Domain field under the **Basic Settings > SIP** tab.
6. Enter the Ring and/or Page SIP extension and credentials. Leave the credentials blank for either extension if there is no intended use to have both registered.

(Note: The speaker supports multiple Ring, Emergency Alert, and Page SIP extensions. The Page extension auto-answers for voice announcements. The Ring and Emergency Alert extensions will play a WAV file over the speaker without answering.)
7. Make a test call from a telephone to the speaker for one or both extensions. The Page SIP extension should auto-answer, play the default pre-announce WAV file, and open a speech path to make a voice announcement. The Ring SIP extension will play the default WAV file from those available in device memory.

Wall Mounting

Mount the wall bracket securely. Once the wall bracket is secure, slide the 8190 onto the bracket. Secure the 8190 to the wall bracket with the provided four screws.

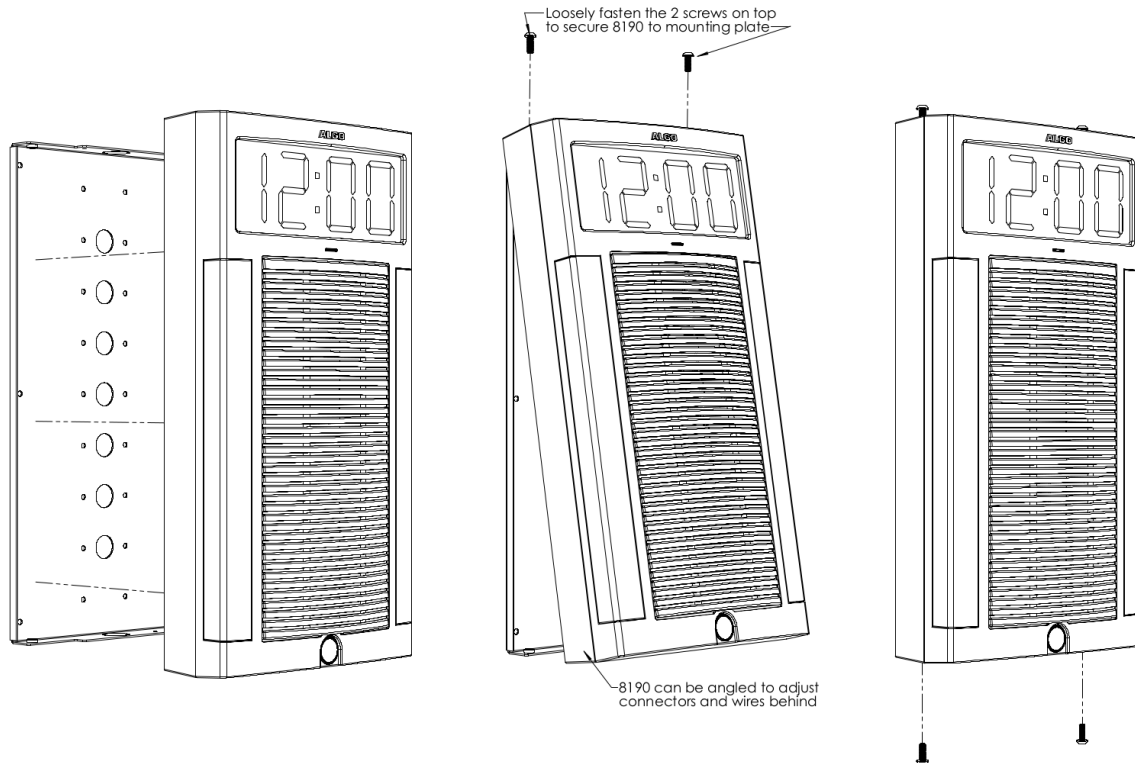

Programming and Configuration

After connecting the 8190 to a network PoE, the blue indicator light at the top will turn on during initialization. The 8190 will then attempt to obtain an IP address from the DHCP server. If there is no DHCP server or the attempt was unsuccessful, the 8190 will default to the static IP address **192.168.1.111**.



Note: If you don't have a PoE switch, you'll need a PoE or PoE+ injector installed between the 8190 and the network switch. The PoE injector will supply 48 Vdc to the 8190. Most PoE injectors are capable of providing more power than the 8190 requires (12.95 W). Ensure that the PoE injector is fully compliant to the IEEE 802.3at PoE+ or 802.3af standard.

After a successful boot up the blue LED will turn off and you will hear a tone, and the speaker will have obtained an IP address.

Press the reset button (RST) momentarily to hear the IP address over the speaker and press it again to stop playing the IP address over the speaker.

The IP address may also be discovered by downloading the Algo locator tool to find Algo devices on your network: www.algosolutions.com/locator

Enter the IP address (e.g. 192.168.1.111) into a browser such as Google Chrome, Firefox, or Internet Explorer (other than IE9). The web interface should be visible and the default password will be **algo** in lower case letters.

Inputs/Outputs

On the back, the 8190 SIP Speaker has an ADC input, relay output, 24V output, and a Door Control relay.

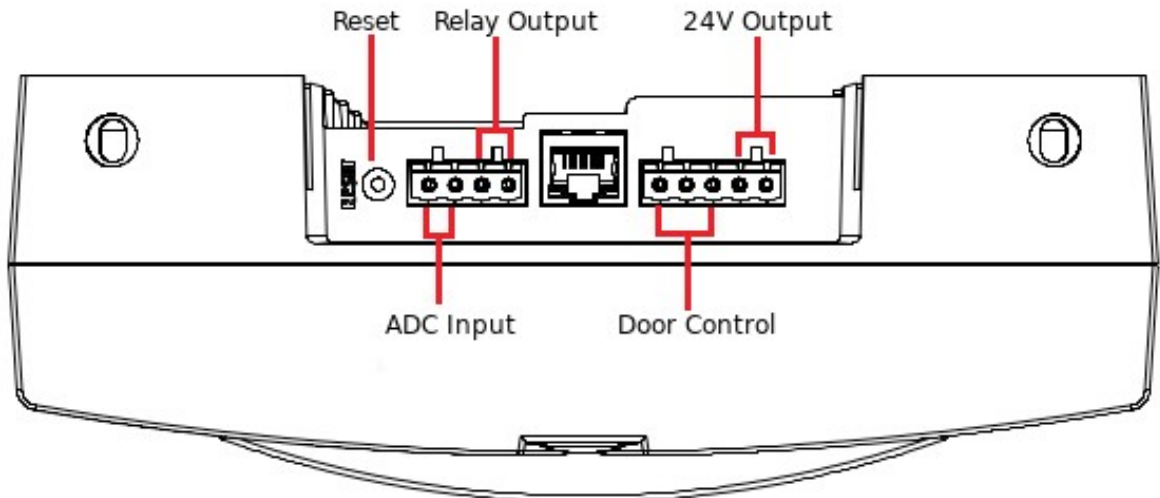

Terminal Block Relay In

By default, these terminals are inactive. Connection options are a normally closed switch, normally open switch, 1202 Call Button, 1203 Call Switch, or EOL resistor termination.

Terminal Block Relay Out

By default these terminals provide a contact closure when the 8190 SIP Classroom Speaker is active.

Door control

The door control provides both normally open (NO), common (C), and normally closed (NC) relay contacts.

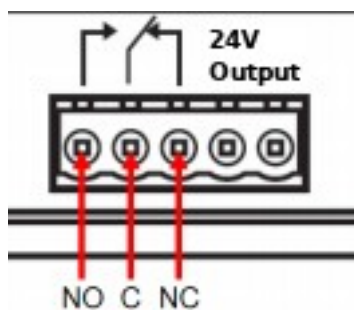

Features

SIP Paging: One 8190

The 8190 SIP speaker can be registered as a third-party SIP extension with a hosted or enterprise Communications Server supporting 3rd party SIP endpoints.

To register the speaker with the SIP server, use the **Basic Settings > SIP** tab in the web interface to enter the Communication Server IP address, extension, username, and password. This information will be available from the IT Administrator.

If VLAN is used, navigate to the **Advanced Settings > Network** tab to set VLAN options.



Important: once the speaker is using VLAN you will need to be on the same VLAN to access the web interface.

The speaker may now be accessed by dialing its assigned extension from a telephone, device, or client. The speaker will auto-answer, play the default WAV pre-announce tone, and allow voice paging until disconnected.

There are a number of configurable speaker options:

- Increase or Decrease Speaker Volume
- Enable AGC (automatic gain control)
- Enable Ambient Noise Monitoring (speaker volume adapts to background noise)
- Enable Talkback
- Customize pre-announce tone WAV file

The best voice paging quality and intelligibility will be obtained using the G.722 wideband audio codec. Most current IP telephones support G.722 which is sometimes referred to as “HD” voice or audio.

SIP Ring Event

Set Monitoring Mode to **'Monitor Ring'** and enter credentials. When a call is made to the SIP extension the 8190 will play the selected WAV file from memory. Often, the 8190 will be part of a hunt group or ring group to ring in conjunction with a telephone.

Multicast Overview

In addition to the ring and page features, the 8190 is able to receive IP audio multicast messages over the network to support larger deployment for both paging and ring/notification. This provides a scalable and efficient method of building large scale notification solutions.

An Algo 8301 can be configured with a SIP Page Extension. When called from a phone, the SIP registered 8301 auto-answers and plays the page audio over its speaker.

Simultaneously, the registered 8301 endpoint broadcasts the audio over the network using RTP multicast to any number/combination of Algo IP speakers, paging adapters, and strobes as required.

The Slave endpoints require a PoE network connection but do not require registration to the communication server.

Multicasting can also be used to distribute loud ring or other alerting (e.g. safety, security, or emergency events) over multiple Algo endpoints (e.g. 8190, 8186, 8188, 8128, 8201, 8301, and 8373).

SIP Paging: Multiple 8190s (Using Multicast)

To use 8190 multicast feature, setup an 8301 Paging Adapter & Scheduler (sold separately), as a Multicast master.

The Master device will page normally while simultaneously streaming audio to the slave speakers. The Slave speakers do not require SIP extensions and do not need to register with the SIP Communication Server.

To enable multicast streaming from the 8190 Paging Adapter & Scheduler go to its web interface and navigate to the **Basic Settings > Multicast** tab. Choose multicast mode '**Master/Sender**' and zone '**All Call**'. The multicast addresses pre-populated in the table, under **Advanced Settings > Advanced Multicast** section, will work in most cases and should only be altered for rare cases.

To enable multicast monitoring in the 8190, go to the web interface for each speaker and again navigate to the **Basic Settings > Multicast** tab. This time though, choose multicast mode '**Slave/Receiver**'. There is no need to select a zone as the speaker will automatically monitor the '**All Call**' zone IP address.

The page pre-announce tone is generated from the Master. The following options are valid for each multicast Slave speaker:

- Increase or Decrease Speaker Volume
- Enable Ambient Noise Monitoring (speaker volume adapts to background noise)

SIP Paging: Multiple Speakers (Using Individual SIP extensions)

In some cases, it may be desirable for every speaker to have a SIP extension. Multicast may still be used to page multiple speakers but each speaker can also be called individually or generate a call when appropriately configured.

A speaker configured as a SIP Multicast Slave will give its highest priority to the 'Priority Call' zone. Other than the 'Priority Call' zone, a page using its SIP extension, has priority over all other multicast zones.

Communication Servers with the capability of dialing many SIP extensions simultaneously for paging may be able to create zones by calling "page groups" and also page telephone speakers in conjunction with overhead speakers.

SIP Activated Notification Alerts

In addition to voice paging, the 8190 can play audio files for emergency, safety, and security announcements, customer service, shift changes, etc.

Audio WAV files can be stored in speaker memory and played over the speaker in response to an event such as a ring or relay input, and also multicast to other Algo SIP endpoints on the network. See **Additional Features > Emergency Alerts** and **Additional Features > Input/Output** for more details.

Background Music Streaming

The 8301 Paging Adapter & Scheduler (sold separately), set as a Multicast master, can stream background music to other Algo slave devices on the network from a music source connected to the 8301's AUX Input.

When multicasting music, ensure that Automatic Gain Control (AGC) is 'Disabled' in **Basic Settings > Features** tab on all the slave devices. Meanwhile, on the Multicast master device, select 'G.722' for the 'Master Output Codec' setting in **Advanced Settings > Advanced Multicast** tab.

Polycom™ Group Paging

The 8190 SIP Classroom Speaker has been designed to support Polycom Group Paging.

The 8190 can be added to a Polycom Group Page so that voice paging is heard over Polycom telephone speakers and overhead paging simultaneously.

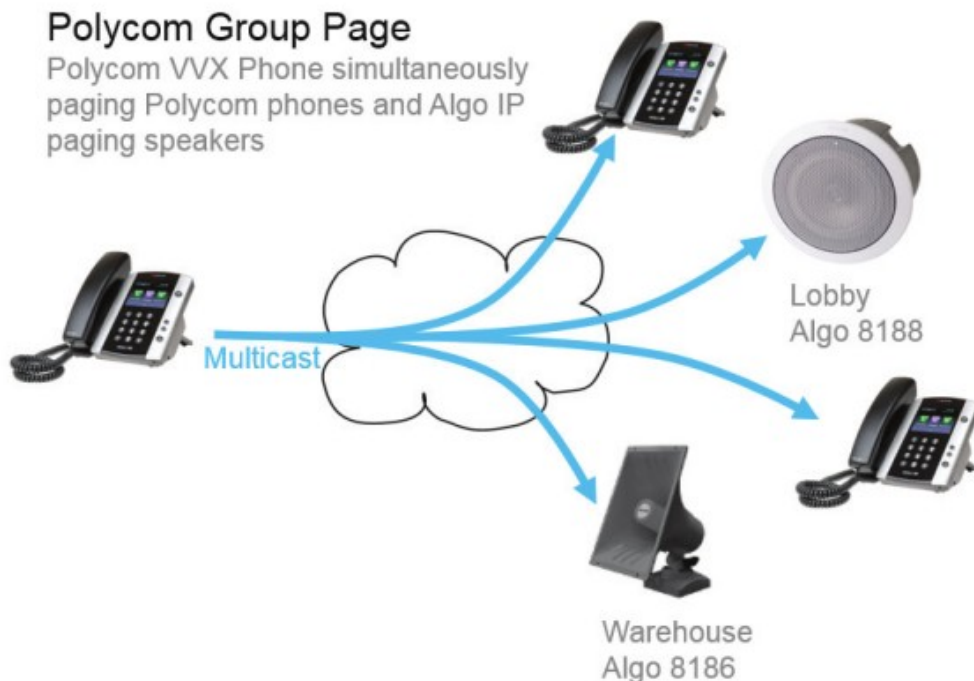

TLS for SIP Signaling and Provisioning

Algo devices that support firmware 1.6.4 or later support Transport Layer Security (TLS). This feature adds security by ensuring that Algo products can trust the hosted SIP server. This is useful for when third-party devices or attackers may try to intercept, replicate, or alter Algo products, and try to connect to the server. TLS protocol will ensure that third parties cannot read/modify any actual data. Previously security was less of a concern because phone systems were on isolated networks, but hosted services are becoming increasingly more common. Using a hosted SIP service requires traffic to be sent over the public internet and thus much more susceptible to attacks. Signed certificates are an important piece in the Algo device's operation, to ensure the security, integrity, and privacy of its communication. Algo components that use TLS are **Provisioning** and **SIP Signaling**.

These Algo devices each come pre-loaded with certificates from a list of trusted certificate authorities (CA), which are installed in the hardware at the time of manufacture. Note these pre-installed trusted certificates are not visible to users and are separate from the 'certs' folder.

The TLS handshake happens to make sure that the client and server can trust each other, and once that trust is established, the two parties can freely send encrypted data and decrypt any data that they receive. After the TLS handshake process is complete, a TLS session is established, and the server and client can then exchange messages that are symmetrically encrypted with shared (pre-master) secret key.

Provisioning

Provisioning is secured by setting the 'Download Method' to 'HTTPS' (under the **Advanced Settings > Provisioning** tab)

Setting provisioning to 'HTTPS' prevents configuration files from being read by unwanted third-party devices/ attackers. This resolves the potential risk of having sensitive data: admin passwords and SIP credentials stolen.



Important: To verify the server you must 'Enable' the 'Validate Server Certificate' option. This then checks if the certificate that is provided by the server is signed by any of the CAs included in the list of trusted CAs (used by the Debian infrastructure and Mozilla browsers). If we receive a certificate signed by any of these CAs, then that server will be trusted. Certificates can also be manually uploaded using the 'File Manager'.

The 'Validate Server Certificate' parameter can also be enabled through provisioning:

```
prov.download.cert = 1
```

SIP Signaling

SIP Signaling is secured by setting 'SIP Transportation' to 'TLS' (under the **Advanced Settings >Advanced SIP** tab)

[Status](#)
[Basic Settings](#)
[Additional Features](#)
[Advanced Settings](#)
[System](#)
[Logout](#)

[Network](#)
[Admin](#)
[Time](#)
[Provisioning](#)
[Tones](#)
[File Manager](#)
[Advanced Audio](#)
[Advanced SIP](#)
[Advanced Multicast](#)

Advanced SIP Settings

General

SIP Transportation:
Select Auto to check DNS NAPTR record, then try UDP/TCP.

SIPS Scheme: Enabled Disabled

SDP SRTP Offer:

SIP Outbound Support (RFC 5626): Enabled Disabled
Enable this option to support best networking practices according to RFC 5626. This option should generally be enabled if the Algo device is being registered with a hosted server or if TLS is being used for SIP Transportation.

Outbound Proxy:

Register Period (seconds):

NAT

Media NAT: None ICE STUN

Server Redundancy

Server Redundancy Feature (Multiple SIP Server Support): Enabled Disabled

Interoperability

Keep-Alive Method: None Double CRLF
This setting will enable sending periodic CRLF messages for both UDP and TCP connections.

Setting 'SIP Transportation' from 'Auto' (default) to 'TLS', ensures the encryption of SIP traffic. Setting 'SDP SRTP Offer' to 'Standard' or 'Optional', means the SIP call's RTP data will be left unencrypted if the other party does not support SRTP. Setting 'SDP SRTP Offer' to 'Standard', encrypts RTP voice data, meaning the normal audio RTP packets will now be secure (SRTP). This means SIP calls will be rejected if other party does not support SRTP. The 'Standard' option secures the audio data between parties, by making sure that it's not left out in the open for third parties to later reconstruct and listen to.

! *Important: In order for a SIP server to validate the Algo device, an additional certificate has to be installed on the Algo device manually. For Firmware v1.7, the only way to add this user certificate file is to use a '.pem' file type extension and have the file named 'sipclient'. This is done by manually adding a file named 'sipclient.pem', which contains a device certificate and private key, to the 'certs' folder (under the 'Advanced Settings' tab File Manager). In the future, '.crt', '.cer', and '.der' certificate extensions will also be supported and you will not be restricted to naming the file 'sipclient.pem'.*

Web Interface Basic Settings

Web Interface Login

The web interface requires a password which is 'algo' by default. This password can be changed in the **Admin** tab after logging in the first time.

 *Web Interface is accessed by entering 8190's IP Address into the web browser.*

 *Important: It is highly recommended to change the default password if the device is directly connected to a public network.*

Status

The device's Status page will be available before and after log on. The section can be used to check 8190's SIP Registration status of the Ring/Page extensions, Call Status, Multicast Mode, Relay Input Status, Proxy Status, and general MAC, IP, Netmask, Date/Time, and Timezone information.

 *The Status page can be hidden when logged out for security purposes under the **Advanced Settings > Admin** tab.*

Basic Settings Tab – SIP

SIP Server information and Credentials should be obtained from your telephone system administrator or hosted account provider. After saving the settings, see the Status page to confirm that the registration was successful.

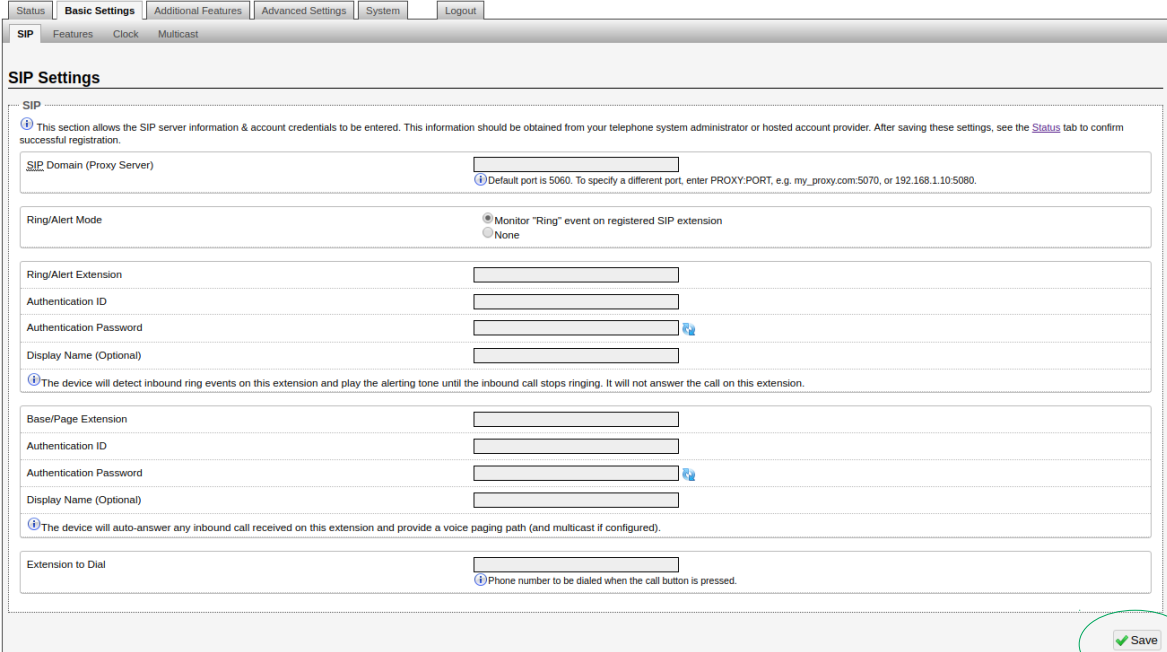

The screenshot displays the 'SIP Settings' configuration page. At the top, there are navigation tabs: Status, Basic Settings, Additional Features, Advanced Settings, System, and Logout. Below these, sub-tabs for SIP, Features, Clock, and Multicast are visible. The main content area is titled 'SIP Settings' and contains several sections with input fields and radio buttons. The first section is for 'SIP' registration, with a help icon and text explaining that information should be obtained from a system administrator. It includes a 'SIP Domain (Proxy Server)' field with a note that the default port is 5060. Below this are radio buttons for 'Ring/Alert Mode', with 'Monitor "Ring" event on registered SIP extension' selected. Further down are fields for 'Ring/Alert Extension', 'Authentication ID', 'Authentication Password', and 'Display Name (Optional)'. A help icon and text explain that the device will detect inbound ring events. The next section is for 'Base/Page Extension', with similar fields for 'Authentication ID', 'Authentication Password', and 'Display Name (Optional)'. A help icon and text explain that the device will auto-answer any inbound call. The final section is 'Extension to Dial' with a field and a note that it is the phone number to be dialed. A green circle highlights the 'Save' button at the bottom right of the form.



Important: Any time changes are made to settings in the web interface the 'Save' button must be clicked to save the changes.

SIP Domain (Proxy Server)

The IP address (e.g. 192.168.1.1) or domain name (e.g. myserver.com) of the SIP Server

Ring/Alert Mode

Option for enabling/disabling/or subscribing to a Ring/Alert SIP extension. If activated, screen expands to enter SIP extension parameters for a Ring/Alert Extension.

The device will detect inbound ring events on this extension and play the alerting tone (and multicast if configured) until the inbound call stops ringing. It will not answer the call on this extension.

Subscribe Notify

Can subscribe to and notify, for when a Ring Extension is dialed ('Ring') and/or when the Ring is answered ('Both Ring & In-Use' or 'In-Use').

You must first configure a 'Page Extension', and then can configure a 'Ring/Alert Extension' to subscribe to.

You can subscribe to just the 'Ring' Alert Event, for which when the ring extension is called, the 8190 will also play that ring over its speaker. You can subscribe to just an 'In-Use' Alert Event as well, for which when the ring extension is called, the 8190 will only play that ring over its speaker once the ring is actually answered. Lastly, you can subscribe to both Alert Events by using 'Both Ring & In-Use', for which the 8190 will play the ring over its speaker, when the subscribed ring extension, is being called and when its in-use.

Ring Extension

This is the SIP extension for the 8190 speaker's Ring parameter. The device will detect inbound ring events on this extension and play the alerting tone (and multicast if required) until the inbound call stops ringing. It will not answer the call on this extension.

Page Extension

This is the SIP extension for the 8190 speaker. The device will auto-answer any inbound call received on this extension and provide a voice paging path (and multicast if configured).

Authentication ID

May also be called Username for some SIP servers and in some cases may be the same as the SIP extension used for the associated Ring and/or Page parameter.

Authentication Password

SIP password provided by the system administrator for the SIP account used for the associated Ring and/or Page parameter.

Extension to Dial

Phone number to be dialed when the Call button on the door station is pressed.

Basic Settings Tab – Features

Ring/Alert Tone

Select WAV file to play when a ring event is detected on the SIP Ring extension. The WAV file may be played immediately to the speaker from the web interface for test purposes using the Play, Loop, and Stop buttons.



Note: This is the “Default” tone that will be played if selected for Multicast, Additional Ring Extension settings.

Ring/Alert Volume

Set speaker volume for SIP ring event. This setting is an amplifier gain control and the output level will also depend on the levels recorded into the source WAV file played from memory. This setting is only used for local tones, and not when receiving multicast (see Page Speaker Volume below).

Ring Limit

Typically set to no limit, this feature can be used to set a limit on how long the speaker will ring before timing out. A new ring event is required before the speaker will play the WAV file again.

Page Speaker Volume

Speaker page volume control for SIP or multicast paging. This setting is an amplifier gain control and output level will depend on streaming level. This setting will apply to all multicast, regardless of content.

Page Mode

A call to the SIP page extension can be one-way, two-way using the integrated microphone, or delayed. In delay mode, the speaker will store the page into memory and then play after disconnect.

In delay mode, press “*” to cancel a page while the recording state is in process to prevent it from being sent after hanging up.

Page Timeout

A time limit may be set for an active page.

Page Tone

Select pre-announce tone for paging. Use only Default, or custom uploaded file. The other pre-installed tone files all contain silence at the end in order to generate ring "cadence" of 6 seconds. This silence will block the voice path for several seconds at the start of a page. The "Default" tone will play the page-notif.wav file.



Note: The "Default Page Tone", in Advanced Multicast, will play the tone set here.

G.722 Support

Enable or disable the G.722 codec.

DTMF Detection Type

What type of DTMF events should be detected and processed by the 8190. If 'Auto' is selected the 8190 will accept the first DTMF type it receives (RTP telephony, RTP in-band, or SIP info) and ignore all other types.

Outbound Ring Limit

Typically set to ensure that a call will not reach voicemail. This feature can be used to set a limit on how long the speaker will ring before timing out

Ringback Tone

Allow audible ringback tone to be played over the speaker until the call is answered.

Allow Call Button to End Active Call

Pressing the call button while a call is active will either end the call or end the call and redial.

Ambient Noise Compensation

To configure, set the volume to an appropriate level for a quiet environment and enable the Ambient Noise Compensation. The integrated microphone will measure the ambient noise during idle periods and automatically increment the speaker volume, if any increase in background noise is detected. Ambient noise level is averaged over 10 seconds. The noise compensation will not be functional when playing background music.

Automatic Gain Control (AGC)

Normalizes the audio level. Automatically maximize level of voice received from calling phone in order to make page volume more consistent.

Basic Settings Tab – Clock

Time Format

Display 24 hour or 12 hour on the clock.

Colon blink to seconds

If enabled, the colon between hours and minutes will blink. If disabled the colon will be on steady.

Clock Brightness Level

Brightness of the LEDs on the clock.

Basic Settings Tab – Multicast

Multicast IP Addresses

Each 8190 SIP Classroom Speaker has its own IP address, and shares common multicast IP and port numbers (multicast zone) for multicast packets. The master device transmits to a configurable multicast zone, and the slave units listen to all the multicast zones assigned to them.

The network switches and router see the packet and deliver it to all the members of the group. The multicast IP and port number must be the same on all the master and slave units of one group. The user may define multiple zones by picking different multicast IP addresses and/or port numbers.

1. Multicast IP addresses range: 224.0.0.0/4 (from 224.0.0.0 to 239.255.255.255)
2. Port numbers range: 1 to 65535
3. By default, the 8190 SIP Classroom Speaker is set to use the multicast IP address 224.0.2.60 and the port numbers 50000-50008

Make sure that the multicast IP address and port number do not conflict with other services and devices on the same network.

Multicast Page Zones

The 8190 SIP Classroom Speaker supports nine “basic” multicast zones. These zones are defined by the multicast IP addresses.

Somewhat arbitrarily, these zones are defined below but may be used in other ways. The important consideration is that there is a priority hierarchy – streaming activity on a zone higher on the list, will be treated as a higher priority than a zone lower on the list – with music being the lowest priority.

1. Priority
2. All Call
3. Zone 1
4. Zone 2
5. Zone 3
6. Zone 4
7. Zone 5
8. Zone 6
9. Music

“Expanded” zones can also be enabled, in the **Basic Settings > Multicast tab**, allowing up to 50 zones in total. These have the same behaviors as the basic zones, but are hidden by default to simplify the interface.

Basic Settings Tab – Multicast (Slave Settings)

Multicast Mode (Slave Selected)

If Slave is enabled the 8190 will activate when receiving a multicast message. Will mimic audio stream, but use local volume settings (‘Page Speaker Volume’ in Basic Settings > Features).

Number of Zones

Select ‘basic’ zones if configuring nine or fewer multicast zones or ‘expanded’ to configure up to 50 zones. The expanded zones have the same behavior as the basic Slave zones, but are hidden by default to simplify the interface.

Multicast Type - Regular

Select ‘Regular (RTP)’ if solely multicasting to Algo SIP endpoint(s) and/or multicast enabled phone(s) that use RTP audio packets.

Multicast Type – Polycom Group Paging/Push-to-Talk

The 8190 may receive multicast paging compatible with Polycom “**on premise group paging**” protocol.

To configure the 8190 as a slave to play Polycom page announcements, select “Group Page” or “Push-to-Talk”. Then enter the Polycom Zone (IP Address and Port) that matches the configuration of the Polycom phones and Channels. The “Default Channel” is the target group in a Polycom paging environment.

The Polycom phone used as page audio source for the 8190 SIP Classroom Speaker(s), must be configured to use either the G.711 or G.722 audio codec. The Polycom phone(s) must also be configured with the “Compatibility” setting (“ptt.compatibilityMode”) disabled in order for this codec setting to be applied.

If using a Polycom phone as the Multicast master, a tone may be set for any of the 25 Polycom Groups configured on the Algo device. If an Algo device is used as a Multicast master, a tone does not have to be set as the Algo master will provide its own tone. Polycom Group Tones can be set in Advanced Settings > Advanced Multicast tab.

Slave Zones

Select one or more multicast zones for the 8190 SIP Classroom Speaker to monitor. Note that multicast zone priority is based on the zone definition list order (top to bottom).

Web Interface Additional Features

Additional Features Tab – Input/Output

Input Relay Terminal Function

When triggered by an input relay, 8190 can perform actions such as playing a pre-recorded announcement over the speaker(s), sending the announcement as a private message to a phone, or initiating a two-way conversation between the speaker and a phone.

Relay Input Mode

The input relay to the 8190 SIP Classroom Speaker(s) can be prompted by any normally open or normally closed switch. Algo offers the 1202 Call Button, the 1203 Call Switch, or the 1204 Volume Control Switch with supervision. Via supervision settings, notification actions can also be triggered if the input switch is disconnected.

1203 Call Switch



The 1203 Call Switch is a simple contact closure switch with an illuminated button and supervision capabilities. When used in conjunction with the 8190, the 1203 can prompt a single action with one-touch, or a continuous action if the button is held.

Mute Switch

Apply an external switch (short-circuit) across the Relay Input terminals 5 & 6 in order to mute the speaker. This allows a temporary "disable" switch to control the device if desired, for example in a boardroom to block paging during important meetings.

Leave the Relay Input terminals open (no-connect) for regular full-volume operation when in this mode.

1202 Call Button



The 1202 Call Button is a one-touch button for event notification and response. It can be used with the 8190 for improved customer service, emergency notification, and non-emergency alerting. The Call Button's one-touch button can trigger a single or continuous action, which can be halted via the small cancel/reset button located below the main call button.

While the 8190 can be configured to play the WAV file only once, it can also be enabled to play it continuously with just one touch on the 1202 Call Button. The action can then be stopped via the smaller oval cancel button located below the main call button on the 1202 Call Button.

1204 Volume Button



The 1204 Volume Control Switch is a simple 2 terminal potentiometer that will allow attenuation below the max volume level (configured under 'Basic Settings > Features')

Algo's 1204 can be used for variable volume control. The maximum volume should still be set in the Basic Settings > Features tab as usual, and then the Volume Control Switch will allow attenuation below this level. Enabling Priority Multicast Override allows priority multicast to override the volume set by the Volume Control Switch. Enabling 'Mute On Lowest Setting' allows audio to be completely muted when volume control switch is turned all the way down.

Action – Play Tone

When the 8190 input is triggered on terminals 5 & 6 ('Relay Terminal Function' must also be configured to 'Input'), a tone or a pre-recorded WAV file will play over the local speaker, or multicast if enabled. This function can be used to call support/assistance in service or retail environments, notify about an emergency at a specific location in medical or educational facilities, or sound an alarm during an intrusion.

- Action When Input Triggered:
 - o Tone/Pre-recorded Announcement
 - o Tone Duration

Action – Make SIP Voice Call

When the 8190 input is triggered on terminals 5 & 6, a voice path will open for an intercom-like call via the 8190 to a pre-configured phone extension. This option can be used when a call needs to be made from a public place where a phone would not be practical to use.

- Action When Input Triggered:
 - o Extension to Dial
 - o Call Mode
 - o Allow 2nd Button Press
- Outbound SIP Call Settings:
 - o Outbound Ring Limit
 - o Ringback Tone
 - o Maximum Call Duration

Action – Make SIP Call with Tone

When the 8190 input is triggered on terminals 5 & 6, a private call can be generated to a pre-configured phone extension with a pre-recorded message. For instance, a call to a supervisor's phone notifying about an emergency or intrusion at some location.

- Action When Input Triggered:
 - Extension to Dial
 - Allow 2nd Button Press
 - Tone/Pre-recorded Announcement
 - Interval Between Tone (seconds)
 - Maximum Tone Duration
- Outbound SIP Call Settings:
 - Outbound Ring Limit
 - Ringback Tone

Action When Tamper Detected (Supervision)

In addition to the main events, the device can be configured with supervision to also execute one of the above three actions in case the device goes offline due to wiring failure or after being tampered with. For example, a tone could sound over the speaker(s), or a private pre-recorded message could be sent to a specified phone extension. The supervision configuration options will appear once a relay option with supervision is selected. See the Electrical Specification section for details on supervision detection circuit.

Extension to Dial

SIP account required in Page Extension fields in order to make a call. Can be configured if 'Make SIP Voice Call' or 'Make SIP Call with Tone' actions are enabled under 'Call Button Settings'.

Interval Between Tones

Specify the time delay (seconds) between tones. Can be configured if 'Play Tone' or 'Make SIP Call with Tone' actions are enabled under 'Call Button Settings'.

Maximum Tone Duration

Select the maximum tone duration. The tone will be terminated once the maximum time is reached. Can be configured if 'Play Tone' or 'Make SIP Call with Tone' actions are enabled.

Call Mode

This setting is available when the 'Make SIP Call with Tone' action is enabled and 'Relay Input Mode' is set to one of the Relay options. If the 'Regular Two-Way Call' setting is chosen, a relay closure will prompt an intercom-like call via the speaker and its microphone to a pre-configured extension. When the "Silent Microphone Monitoring" is enabled, the relay will prompt only the audio from the 8190's microphone to be heard at the pre-configured extension, while the speaker remains silent. This setting is ideal in settings where silent emergency calls to a pre-configured extension may be needed with a single press of a button.

Allow 2nd Button Press

If enabled, 2nd button press will either simply End Call or End and Restart Call. Therefore, if an input is triggered for the second time on terminals 5 & 6 (since the first input trigger enables one of the four actions listed above) the SIP call will either simply be terminated or terminated and immediately called again.

Outbound Ring Limit

Typically set to ensure that a call will not reach voicemail. This feature, under 'Outbound SIP Call Settings', can be used to set a limit on how long the speaker will ring before timing out.

Ring back Tone

If enabled, under 'Outbound SIP Call Settings', a ringback tone will play over the speaker during an outbound SIP call, while waiting for the far-end party to answer.

Maximum Call Duration

Select the maximum call length. The call will be terminated once the maximum time is reached. In the event that a call inadvertently reaches voicemail or gets accidentally left on hold, this setting ensures that the 8190 returns on-hook.

Output Light

Enable/Disable the blue light on the speaker entirely (keep the light off even when the speaker is active).

Heartbeat Light

If enabled, the small blue indicator will flash every 30 seconds as visual confirmation that the 8190 is powered and running.

Output Relay

Only visible when 'Relay Terminal Function' set to 'Output'.

Call Button Backlight

Enable/Disable call button backlighting.

Additional Features Tab – Emergency Alerts

Emergency Alerts allow for an announcement to be triggered & latched by calling a pre-configured Emergency extension and hanging up. The announcement will continue to play until a different "Cancel" extension is called to clear the announcement (or a defined timeout is reached). The Emergency Alerts are useful for emergency notifications (e.g. evacuation, lock down, medical emergency, etc.), allowing staff to quickly dial a pre-configured number under such circumstances.

If the "Answer Inbound Call" option is "Enabled" the call is auto-answered and a confirmation tone is played before starting the alert. If "Disabled", the alert is triggered just by the inbound ring, without answering the call. (In both instances, the announcement will play until the time limit is reached or the "Cancel Extension" is called). The auto-answering option can be useful when the caller cannot hear announcement from their location. However, in instances where the call might go to a group/multiple extensions (including this device), the auto-answer may intercept that call and prevent it from ringing on other devices.

Up to 10 extensions can be registered allowing up to 10 different announcements. Audio files can also be easily uploaded to create custom announcements.



Note: Some SIP phone systems may not support this feature if they limit the number of extensions that can be registered on a single device.

Additional Features Tab – More Ring Extensions

Up to 10 SIP Ring extensions can be registered. To configure additional ring extensions, click "Enable" beside the target extension and enter the Extension, Authentication ID, and Authentication password. A unique Ring Tone can be assigned to each extension if desired.

Web Interface Advanced Settings

Advanced Settings Tab – Network

Protocol

DHCP is an IP standard designed to make administration of IP addresses simpler. When selected, DHCP will automatically configure IP addresses for each 8190 on the network. Alternatively, the 8190 can be set to a static IP address.

VLAN Mode

Enables or Disables VLAN Tagging. VLAN Tagging is the networking standard that supports Virtual LANs (VLANs) on an Ethernet network. The standard defines a system of VLAN tagging for Ethernet frames and the accompanying procedures to be used by bridges and switches in handling such frames. The standard also provides provisions for a quality of service prioritization scheme commonly known as IEEE 802.1p and defines the Generic Attribute Registration Protocol.

VLAN ID

Specifies the VLAN to which the Ethernet frame belongs. A 12-bit field specifying the VLAN to which the Ethernet frame belongs. The hexadecimal values of 0x000 and 0xFF are reserved. All other values may be used as VLAN identifiers, allowing up to 4094 VLANs. The reserved value 0x000 indicates that the frame does not belong to any VLAN; in this case, the 802.1Q tag specifies only a priority and is referred to as a priority tag. On bridges, VLAN 1 (the default VLAN ID) is often reserved for a management VLAN; this is vendor specific.

VLAN Priority

Sets the frame priority level. Otherwise known as Priority Code Point (PCP), VLAN Priority is a 3-bit field which refers to the IEEE 802.1p priority. It indicates the frame priority level. Values are from 0 (lowest) to 7 (highest).

802.1x Authentication

Credentials to access LAN or WLAN that have 802.1X network access control (NAC) enabled. This information will be available from the IT Administrator.

Differentiated Services (6-bit DSCP value)

Provides quality of service if the DSCP protocol is supported on your network. Can be specified independently for SIP control packets versus RTP audio packets.

DNS Caching Mode

In "SIP" mode, only the results of DNS queries for SIP requests will be cached. In "All" mode, the results of all DNS queries will be cached.

Advanced Settings Tab – Admin

The screenshot displays the 'Advanced Settings' tab for the 'Admin' user. The interface includes a top navigation bar with tabs for Status, Basic Settings, Additional Features, Advanced Settings (selected), System, and Logout. Below this is a sub-navigation bar with tabs for Network, Admin (selected), Time, Provisioning, Tones, File Manager, Advanced Audio, Advanced SIP, and Advanced Multicast.

The main content area is titled 'Admin Settings' and is organized into several sections:

- Admin Password:** Contains two text input fields for 'Password' and 'Confirmation', each with a copy icon.
- General:** Includes 'Device Name (Hostname)' (sipalerter), 'Introduction Section on Status Page' (On/Off), 'Show Status Section on Status Page when Logged Out' (On/Off), 'Web Interface Session Timeout' (1 hour), and 'Play Tone at Startup' (Enabled/Disabled).
- Log Settings:** Includes 'Log Level' (Error, Notice, Info, Debug), 'Log Method' (Local, Network, Both), and 'Log Server'.
- Management:** Includes 'Web Interface Protocol' (Both HTTP and HTTPS, HTTPS Only), 'Force Strong Password' (Enabled/Disabled), 'Allow Secure SIP Passwords' (Enabled/Disabled), and 'SNMP Support' (Enabled/Disabled).
- System Integrity:** Includes 'System Integrity Checking' (Enabled/Disabled) and a 'Perform Check' button labeled 'Run'.
- Syn-Apps:** Includes 'SA-Announce Support' (Enabled/Disabled), 'SA-Announce Server' (text input), and 'Local Management Port' (6789).
- InformaCast:** Includes 'InformaCast Support' (Enabled/Disabled).

A 'Save' button is located at the bottom right of the settings area.

Password

Password to log into the 8190 SIP Classroom Speaker web interface. You should change the default password **algo** in order to secure the device on the network. If you have forgotten your password, you will need to perform a reset using the Reset Button in order to restore the password (as well as all other settings) back to the original factory default conditions.

For additional password security see “Force Strong Password” below.

Confirmation

Re-enter network admin password.

Device Name (Hostname)

Name to identify the device in the Algo Network Device Locator Tool.

Introduction Section on Status Page

Allows the introduction text to be hidden from the login screen.

Show Status Section on Status Page when Logged Out

Use this option if you wish to block access to the status page when logged out. The settings and configurations, on the status page, will be hidden entirely unless you're logged in – this feature is useful when you want only trusted users to view possible sensitive device information.

Web Interface Session Timeout

Set the maximum period of inactivity after which the web interface will log out automatically.

Play Tone at Startup

A tone can be played at startup to confirm that the device has booted.

Log Level

Use on the advice of Algo technical support only.

Log Method

Allows the 8190 to write to external Syslog server if the option for external (or both) is selected.

Log Server

If external (or both) is selected this is the address of the Syslog server on the network.

Web Interface Protocol

HTTPS is always enabled on the device. Use this setting to disable HTTP. When HTTP is disabled, requests will be automatically redirected to HTTPS. Also note that since the device can have any address on the local network, no security certificate exists, and thus most browsers will provide a warning when using HTTPS.

Force Strong Password

When enabled, ensures that a secure password is provided for the device's web interface for additional protection. The password requirements are:

- Must contain at least 10 characters
- Must contain at least 1 uppercase character
- Must contain at least 1 digit (0 – 9)

- Must contain at least 1 special character

Allow Secure SIP Password

Allows SIP passwords to be stored in the configuration file in an encrypted format, to prevent viewing and recovery. Once enabled, the SIP “Realm” field should be entered and all the configured Authentication Password(s) must be re-entered in the Basic Settings > SIP tab, and any other locations where SIP extension have been configured, to save the encrypted password(s).

If the Realm is changed at a later time, all the passwords will also need to be re-entered again to save the passwords with the new encryption.

To obtain your SIP Realm information, contact your SIP Server administrator (or check the SIP log file for a registration attempt). The Realms may be the same or different for all the extensions used.

SNMP Support

Additional SNMP support is anticipated for future, but the 8190 SIP Classroom Speaker will respond to a simple status query for automated supervision. Contact Algo technical support for more information.

System Integrity Checking

This feature verifies installed system packages to ensure they have not been tampered with by running ‘Perform Check’. Enabling this feature may cause reboots and upgrades to take 30 seconds longer. Verification results can be found on the Status page.

SA-Announce Support

Syn-Apps’ SA-Announce paging application converts unicast streams to multicast and delivers them to the target endpoints. The feature can only be used on the 8190 when Multicast Master Mode is disabled (set to ‘None’) in the Basic Settings > Multicast tab.

SA-Announce Server

Enter the SA-Announce Server to use the Syn-Apps paging feature. To use the server provided by the DHCP Option 72, leave the field blank.

Local Management Port

Enter the local management port for the SA-Announce Server.

InformaCast Support

This feature requires a valid InformaCast license to be activated. Please contact sales@algosolutions.com for assistance.

Advanced Settings Tab – Time

Network time is used for logging events into memory for troubleshooting.

Time Zone

Select time zone.

NTP Time Servers 1/2/3/4

The speaker will attempt to use Timer Server 1 and work down the list if one or more of the time servers become unresponsive.

NTP Time Server Source

When “Use DHCP Option 42” is chosen, if an NTP Server address is provided via the DHCP Option 42, that NTP Server will be used instead of the 4 mentioned above. Alternatively, “Ignore DHCP Option 42” can be chosen to only use servers mentioned above.

Device Date/Time

This field shows the current time and date as set on the device. If testing the device on a lab network that may not have access to an external NTP server, the “Sync with browser” button can be used to temporarily set the time on the device.



Note: This time value will be lost at power down, or overwritten if NTP is currently active. Time and date are used only for logging purposes and are not typically required.

Advanced Settings Tab – Provisioning

The screenshot shows the 'Provisioning Settings' page. At the top, there are tabs for 'Status', 'Basic Settings', 'Additional Features', 'Advanced Settings', 'System', and 'Logout'. Below these are sub-tabs: 'Network', 'Admin', 'Time', 'Provisioning', 'Tones', 'File Manager', 'Advanced Audio', 'Advanced SIP', and 'Advanced Multicast'. The 'Provisioning Settings' section includes:

- Mode:** A dropdown menu set to 'Provisioning Mode' with radio buttons for 'Enabled' (selected) and 'Disabled'.
- Settings:**
 - Server Method:** Radio buttons for 'Auto (DHCP Option 66/160/150)', 'DHCP Option 66 only', 'DHCP Option 160 only', 'DHCP Option 150 only', and 'Static' (selected). A note below states: 'Auto mode automatically checks all 3 DHCP options for an active provisioning server, in the order listed.'
 - Static Server:** An empty text input field.
 - Download Method:** Radio buttons for 'TFTP', 'FTP', 'HTTP', and 'HTTPS' (selected).
 - Validate Server Certificate:** Radio buttons for 'Enabled' and 'Disabled' (selected).
 - Auth User Name:** An empty text input field.
 - Auth Password:** An empty password input field with a show/hide icon.
 - Config Download Path:** An empty text input field.
 - Firmware Download Path:** An empty text input field.
 - Partial Provisioning:** Radio buttons for 'Enabled' and 'Disabled' (selected). A note below states: 'Allow support for "-" incremental provisioning files. Disable for enhanced security if not using this feature.'

A 'Save' button with a green checkmark is located at the bottom right of the settings area.

 *Note: It is recommended that Provisioning Mode be set to Disabled if this feature is not in use. This will prevent unauthorized re-configuration of the device if DHCP is used.*

Provisioning allows installers to pre-configure 8190 SIP Classroom Speaker units prior to installation on a network. It is typically used for large deployments to save time and ensure consistent setups.

The device can be provisioned via the Auto mode (where all three DHCP options (Option 66/160/150) will be automatically checked for an active provisioning server), just one of the three specified DHCP options, or a Static Server. In addition, there are four different ways to download provisioning files from a "Provisioning Server": TFTP (Trivial File Transfer Protocol), FTP, HTTP, or HTTPS.

For example, 8190 configuration files can be automatically downloaded from a TFTP server using DHCP Option 66. This option code (when set) supplies a TFTP boot server address to the DHCP client to boot from.

 *Important: DHCP must be enabled if using DHCP Option 66/160/150, in order for Provisioning to work.*

One of two files can be uploaded on the Provisioning Server (for access via TFTP, FTP, HTTP, or HTTPS):

Generic (for all Algo 8190 Speakers) **algot8190.conf**

Specific (for a specific MAC address) **algot[MAC].conf**

Both protocol and path is supported for Option 66, allowing for <http://myserver.com/config-path> to be used.

MD5 Checksum

In addition to the **.conf** file, an **.md5** checksum file must also be uploaded to the Provisioning server. This checksum file is used to verify that the **.conf** file is transferred correctly without error.

A tool such as can be found at the website address below may be used to generate this file: <http://www.fourmilab.ch/md5>

The application doesn't need an installation. To use the tool, simply unzip and run the application (md5) from a command prompt. The proper **.md5** file will be generated in the same directory.

If using the above tool, be sure to use the "-l" parameter to generate lower case letters.

Generating a generic configuration file

1. Connect 8190 to the network
2. Access the 8190 Web Interface Control Panel
3. Configure the 8190 with desired options
4. Click on the System tab and then Maintenance.
5. Click "Download" to download the current configuration file
6. Save the file settings.txt
7. Rename file settings.txt to **algot8190.conf**
8. File **algot8190.conf** can now be uploaded onto the Provisioning server

If using a generic configuration file, extensions and credentials have to be entered manually once the 8190 SIP Classroom Speaker has automatically downloaded the configuration file.

Generating a specific configuration file

1. Follow steps 1 to 6 as listed in the section "Generating a generic configuration file".
2. Rename file settings.txt to **algot[MAC address].conf** (e.g. **algot0022EE020009.conf**)
3. File **algot[MAC address].conf** can now be uploaded on the Provisioning server.

The specific configuration file will only be downloaded by the 8190 with the MAC address specified in the configuration file name. Since all the necessary settings can be included in this file, the 8190 will be ready to work immediately after the configuration file is

downloaded. The MAC address of each 8190 speaker can be found on the back label of the unit.

For more Algo SIP endpoint provisioning information, see:

www.algosolutions.com/provision

Advanced Settings Tab – File Manager

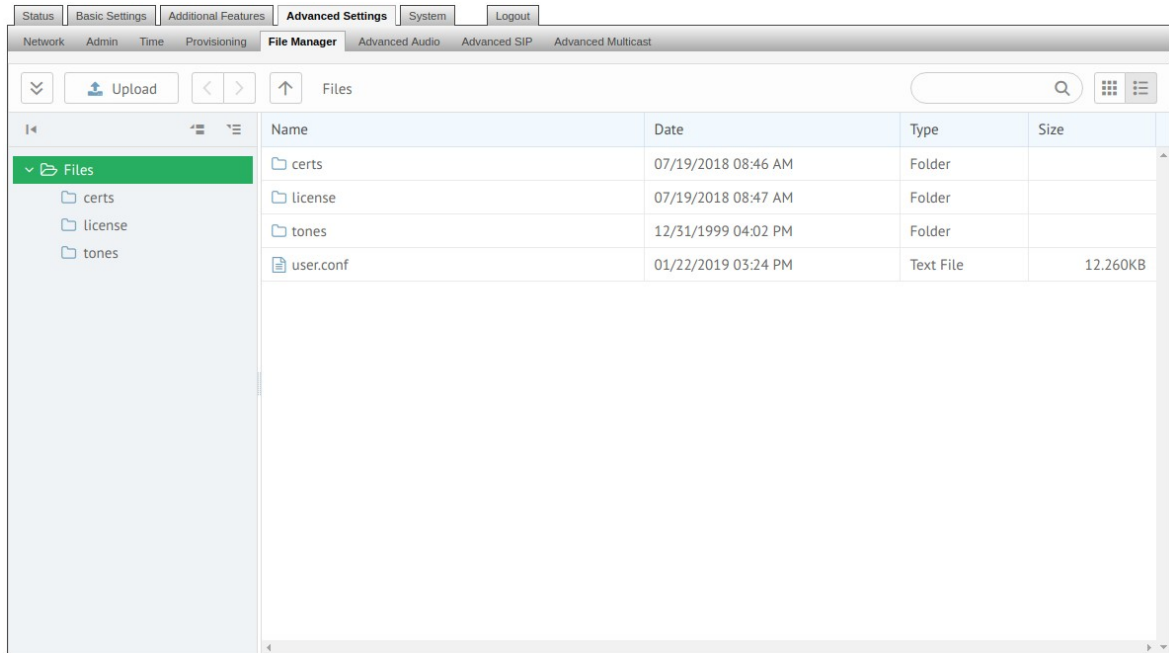

Uploading Custom Audio Files

Custom audio files (WAV format) may be uploaded into memory (1 GB) to play for notification applications. Place your audio files into the **tones** directory.

An existing file may also be modified by downloading the original by right clicking the tone and selecting 'Download', making the desired changes, and then uploading the new version with a different name. Audio files must be in the following format:

- WAV format
- 8 kHz or 16 kHz sampling rate
- 16-bit PCM or u-law
- Mono
- Smaller than 200MB

File names must be limited to 32 characters, with no spaces.

Tone Files Included in Memory

The 8190 SIP Classroom Speaker includes several pre-loaded WAV files that can be selected to play for various events. The web interface allows selection of the WAV file and also the ability to play the WAV file immediately over the speaker for testing. Files may also be deleted or renamed.

Advanced Settings Tab – Advanced Audio

The screenshot shows the 'Advanced Audio Functions' configuration page. It is divided into two main sections: 'Functions' and 'Audio Filters'.
Functions Section:
 - **Dynamic Range Compression (DRC):** Radio buttons for 'Enabled' and 'Disabled'. A help icon indicates: 'Compress the dynamic range of page audio to increase loudness.'
 - **Jitter Buffer Range (milliseconds, 10 ~ 500):** A text input field containing '100'. A help icon indicates: 'Adds more buffering if necessary to correct for inconsistent delays on the network. Use of the lowest value generally is recommended.'
 - **Always Send RTP Media:** Radio buttons for 'Enabled' and 'Disabled'.
Audio Filters Section:
 - **Speaker Filter:** A dropdown menu set to 'None'. A help icon indicates: 'Bandwidth also limited by audio codecs.'
 - **Speaker Noise Filter:** Radio buttons for 'Enabled' and 'Disabled'. A help icon indicates: 'Aggressive 8th order Elliptical Filter (fc = 145Hz)'.
 - **Microphone Filter:** A dropdown menu set to 'None'.
 - **Microphone Noise Filter:** Radio buttons for 'Enabled' and 'Disabled'. A help icon indicates: 'Aggressive 8th order Elliptical Filter (fc = 145Hz)'.
 A 'Save' button with a green checkmark is located at the bottom right of the form.

Dynamic Range Compression (DRC)

If enabled, compresses the dynamic range of page audio to increase loudness.

Dynamic Range Compression Gain

'Dynamic Range Compression' must be enabled to display this setting. Higher compression gain increases distortion.

Jitter Buffer Range

The jitter buffer removes the jitter in arriving network packets by temporarily storing them. This process corrects the inconsistent delays on the network. It is recommended to use the lowest value.

Always Send RTP Media

If enabled, audio packets will be sent at all times, even during one-way paging mode. This option is needed in cases when the server expects to see audio packets at all times.

Speaker Filter

Applies a high-pass filter to the speaker output. Used to reduce audio artifacts like humming or buzzing by filtering out unwanted frequencies.

Speaker Noise Filter

Enables heavy filtering below 145Hz to reduce mains induced noise (fans).

Microphone Filter

Applies a high-pass filter to the microphone input. Used to reduce audio artifacts like humming or buzzing by filtering out unwanted frequencies.

Microphone Noise Filter

Enables heavy filtering below 145Hz to reduce mains induced noise (fans).

Advanced Settings Tab – Advanced SIP

The screenshot displays the 'Advanced SIP Settings' web interface. At the top, there are navigation tabs: Status, Basic Settings, Additional Features, **Advanced Settings**, System, and Logout. Below these are sub-tabs: Network, Admin, Time, Provisioning, File Manager, Advanced Audio, **Advanced SIP**, and Advanced Multicast. The main content area is titled 'Advanced SIP Settings' and is divided into several sections:

- General:**
 - SIP Transportation:** A dropdown menu set to 'AUTO'. Below it are three informational icons: 1) 'Select Auto to check DNS NAPTR record, then try UDP/TCP.' 2) 'In TLS mode, if the SIP Server requires endpoints to be authenticated, a PEM file containing both a device certificate and a private key needs to be installed on the Algo device. Use the "Advanced Settings > File Manager" tab to upload a certificate file renamed to 'sipclient.pem' in the 'certs' folder.' 3) 'To force the Algo device to authenticate the SIP server, a certificate obtained from the SIP server needs to be installed. Use the "Advanced Settings > File Manager" tab to upload a certificate file renamed to 'siptrusted.pem' in the 'certs' folder.'
 - SDP SRTP Offer:** A dropdown menu set to 'Disabled'.
 - SIP Outbound Support (RFC 5626):** Radio buttons for 'Enabled' and 'Disabled', with 'Disabled' selected. Below is an informational icon: 'Enable this option to support best networking practices according to RFC 5626. This option should generally be enabled if the Algo device is being registered with a hosted server or if TLS is being used for SIP Transportation.'
 - Outbound Proxy:** An empty text input field.
 - Register Period (seconds):** A text input field containing '3600'.
- NAT:**
 - Media NAT:** Radio buttons for 'None', 'ICE', and 'STUN', with 'None' selected.
- Server Redundancy:**
 - Server Redundancy Feature (Multiple SIP Server Support):** Radio buttons for 'Enabled' and 'Disabled', with 'Disabled' selected.
- Interoperability:**
 - Keep-Alive Method:** Radio buttons for 'None' and 'Double CRLF', with 'None' selected. Below is an informational icon: 'This setting will enable sending periodic CRLF messages for both UDP and TCP connections.'
 - Use Outgoing TLS port in SIP headers:** Radio buttons for 'Enabled' and 'Disabled', with 'Enabled' selected. Below is an informational icon: 'Use ephemeral port number from outgoing SIP TLS connection instead of listening port number in SIP Contact and Via headers. This is useful to connect the device to some local SIP servers, like Asterisk or FreeSWITCH.'
 - Do Not Reuse Authorization Headers:** Radio buttons for 'Enabled' and 'Disabled', with 'Disabled' selected. Below is an informational icon: 'When enabled, all SIP authorization information from the last successful request will not be reused in the next request.'

A green 'Save' button with a checkmark is located at the bottom right of the form.

SIP Transportation

Which transport layer protocol to use for SIP messages. Setting 'SIP Transportation' to 'TLS', ensures the encryption of SIP traffic.

SIPS Scheme

Only visible when 'SIP Transportation' set to 'TLS'. Enabling SIPS Scheme requires the SIP connection from endpoint to endpoint to be secure.

SDP SRTP Offer

Setting 'SDP SRTP Offer' to 'Optional', means the SIP call's RTP data will be left unencrypted if the other party does not support SRTP. Setting 'SDP SRTP Offer' to 'Standard', encrypts RTP voice data, meaning the normal audio RTP packets will now be secure (SRTP). This means SIP calls will be rejected if other party does not support SRTP. The 'Standard' option secures the audio data between parties, by making sure that it's not left out in the open for third parties to later reconstruct and listen to.

SIP Outbound Support (RFC 5626)

Enable this option to support best networking practices according to RFC 5626. This option should generally be enabled if the Algo device is being registered with a hosted server or if TLS is being used for SIP Transportation.

Outbound Proxy

IP address for outbound proxy. A proxy (server) stands between a private network and the internet.

Register Period (seconds)

Maximum requested period of time where the 8190 SIP Classroom Speaker will re-register with the SIP server. Default setting is 3600 seconds (1 hour). Only change if instructed otherwise.

Media NAT

IP address for STUN server if present or IP address/credentials for a TURN server.

Server Redundancy Feature

Two secondary SIP servers may be configured. The 8190 SIP Classroom Speaker will attempt to register with the primary server but switch to a secondary server if necessary. The configuration allows re-registration to the primary server upon availability or to stay with a server until unresponsive.

Backup Server #1

Only visible if 'Server Redundancy Feature' is enabled. If primary server is unreachable the 8190 SIP Classroom Speaker will attempt to register with the backup servers. If enabled, the 8190 will always attempt to register with the highest priority server.

Backup Server #2

Only visible if 'Server Redundancy Feature' is enabled. If backup server #1 is unreachable the 8190 SIP Classroom Speaker will attempt to register with the 2nd backup server. If enabled, the 8190 will always attempt to register with the highest priority server.

Polling Intervals (seconds)

Only visible if 'Server Redundancy Feature' is enabled. Time period between sending monitoring packets to each server. Non-active servers are always polled, and active server may optionally be polled (see below).

Poll Active Server

Only visible if 'Server Redundancy Feature' is enabled. Explicitly poll current server to monitor availability. May also be handled automatically by other regular events, so can be disabled to reduce network traffic.

Automatic Failback

Only visible if 'Server Redundancy Feature' is enabled. Reconnect with higher priority server once available, even if backup connection is still fine.

Polling Method

Only visible if 'Server Redundancy Feature' is enabled. SIP message used to poll servers to monitor availability.

Keep-alive Method

If Double CRLF is selected the 8190 will periodically send a CRLF message for both UDP and TCP connections to maintain connection with the SIP Server.

Keep-alive Interval

Interval in seconds that the CRLF message should be sent.

Use Outgoing TLS port in SIP headers

Use ephemeral port number from outgoing SIP TLS connection instead of listening port number in SIP Contact and Via headers. This is useful to connect the device to some local SIP servers, like Asterisk or FreeSWITCH.

Do Not Reuse Authorization Headers

When enabled, all SIP authorization information from the last successful request will not be reused in the next request.

Advanced Settings Tab – Advanced Multicast

The default prepopulated multicast addresses above will work in most cases and should only be altered for rare cases.

Audio Sync (Slave Mode)

When using multicast with other third-party devices that have a delay in their audio path, the audio on the 8190 may be heard slightly earlier than on these other devices. By adding audio delay up to one second, the 8190 may be synchronized with other speakers or telephones that have greater latency. This feature applies to Multicast Slave mode only.

RTCP Port Selection

Select the port on which RTCP packets will be sent or received. If using the 'Next Higher Port' option, ensure that the default multicast zone definitions are modified such that zones are only assigned to even-numbered ports, leaving the next higher odd-numbered ports free for RTCP packets.

Zone Definition

The "Expanded" Slave or Master zones can be enabled/disabled in Basic Settings > Multicast. Default IP addresses and ports may be revised for any given zone in the table.



Important: Ensure that the Address and Port settings are the same for all master and slave devices.

Page Tone and Page Volume

When an Algo device is the multicast Master, a page tone will play on the Slave device, so it is recommended to set the Slave tone to “None”. If a page is received from a non-Algo device that doesn’t send a tone, a tone can be inserted on the Slaves (above) each time they detect page audio starting, allowing them to play a tone.

By default, the same page volume can be set for all Slave zones in the Basic Settings > Features tab. Unique page volumes may be revised on a per-zone basis in the table above. For instance, emergency pages can be louder on certain Slave speakers.

Polycom Slave Tones

Available if Multicast Slave and “Polycom Group Page” or “Polycom Push-to-Talk” are selected in the Basic Settings > Multicast tab. A tone may be set for any of the 25 Polycom Groups. If using an Algo device as a Multicast master, it is recommended to set the slave tones to “None” to avoid conflicts, as the Algo devices already multicast a tone by default.

Web Interface System

System Tab – Maintenance

The screenshot shows the 'System Maintenance' page in the ALGO web interface. At the top, there are navigation tabs: Status, Basic Settings, Additional Features, Advanced Settings, System (selected), and Logout. Below these are sub-tabs: Maintenance (selected), System Log, Credits, and About. The main content area is titled 'System Maintenance' and is divided into three sections:

- Backup / Restore Configuration:** Contains three rows:
 - 'Download Configuration File' with a 'Download' button.
 - 'Restore Configuration File' with 'Choose File' and 'No file chosen' buttons, and a 'Restore' button.
 - 'Restore Configuration to Defaults' with a 'Restore Defaults' button.
- Backup / Restore All User Files:** Contains three rows:
 - 'Download Backup Zip File' with a 'Download' button.
 - 'Restore from Backup Zip File' with 'Choose File' and 'No file chosen' buttons, and a 'Restore' button.
 - 'Restore All Settings and Files to Defaults' with a 'Restore Defaults and Delete Files' button. Below this is a warning icon and text: 'All preloaded and uploaded files, including tone files, will be deleted.'
- Reboot:** Contains one row: 'Reboot the device' with a 'Reboot' button.
- Upgrade to New Firmware:** Contains four rows:
 - 'Method' with radio buttons for 'From Local Files' (selected) and 'From URL'.
 - 'Firmware Image' with 'Choose File' and 'No file chosen' buttons.
 - 'MD5 Checksum' with 'Choose File' and 'No file chosen' buttons.
 - An 'Upgrade' button.

Download Configuration File

Save the device settings to a text file for backup or to setup a provisioning configuration file.

Restore Configuration File

Restore settings from a backup file.

Restore Configuration to Defaults

Resets all 8190 SIP Classroom Speaker device settings to factory default values.

Download Backup File

Saves the device settings (configuration) and all the files in File Manager: certificates, licenses, and tones to a backup zip file.

Restore from Backup Zip File

Restores the device settings (configuration) and all the files in File Manager: certificates, licenses, and tones from a backup zip file

Restore All Settings and Files to Defaults

Resets the device settings (configuration) and all the files in File Manager: certificates, licenses, and tones to factory default values.

Reboot the Device

Reboots the device.

Method

Specify whether the firmware files will be downloaded from the local computer or a remote URL.

Firmware Image

Point to the firmware image provided by Algo.

MD5 Checksum

Point to the checksum file provided by Algo.

How To Upgrade 8190 SIP Classroom Speaker Firmware

1. From the top menu, click on System, then Maintenance.
2. In the Upgrade section, click on Choose File and select the 8190 speaker firmware file to upload. Note that both the FW firmware and MD5 checksum files must be loaded.
3. Click Upgrade
4. After the upgrade is complete, confirm that the firmware version has changed (refer to top right of Control Panel).

System Tab – System Log

System log files are automatically created and assist with troubleshooting in the event the 8190 SIP Classroom Speaker does not behave as expected.

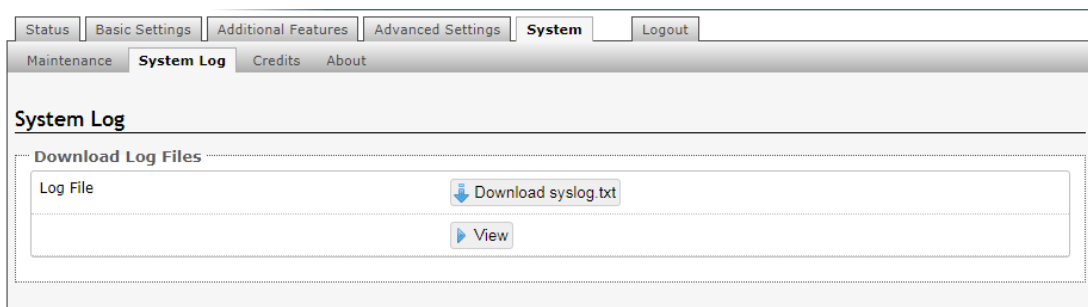

Wiring Connections

Network Connection

The speaker provides a RJ45 jack for network connection. A cable run from the switch can be terminated to a modular jack with connection by patch cord, or terminated with a RJ45 plug.

PoE (Power over Ethernet) must be 48V 350 mA IEEE 802.3at PoE+ or 802.3af compliant whether provided by the network switch or injector.

There are two lights on the Ethernet jack:

Green light: On when Ethernet is working, flickers off to indicate activity on the port.

Amber light: Off when successful 100Mbps link is established. Typically On only briefly at power up.

Under normal conditions, the Amber light will turn on immediately after the Ethernet cable is first connected. This indicates that PoE power has been successfully applied. Once the device connects to the network, it will switch to the Green light instead, which will typically flicker indicating traffic on the network.

Connecting Input Devices

The dry contact relay on the 8190 SIP Classroom Speaker can be prompted by any normally open, normally closed switch, Algo 1202 Call Button, Algo 1203 Call Switch, or Algo 1204 Volume Control Switch. The input switches can be connected to the back of the back of the 8190 via the “Dry Contact Relay”.

Connection options can be configured from normally open switch, to normally closed switch, to Algo 1202 Call Button with large blue button, to Algo 1203 single gang backlit Call Switch, to Algo 1204 Volume Control Switch, or as an EOL resistor termination. The connection options can then be configured to complete an ‘Action’ when Relay Input is triggered.

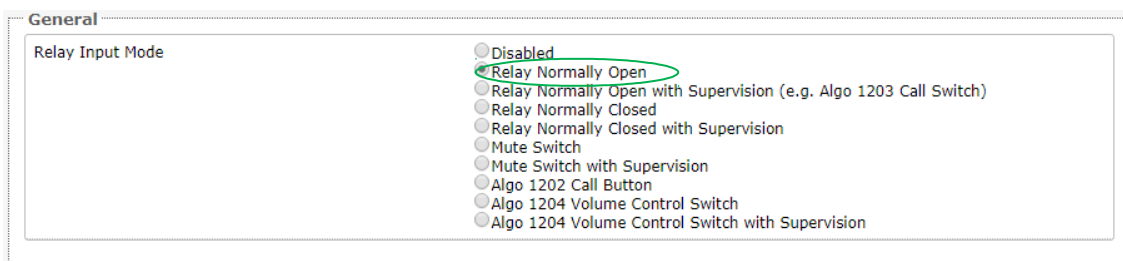

Action When Input Triggered	
Action	<input checked="" type="radio"/> Play Tone <input type="radio"/> Make SIP Voice Call <input type="radio"/> Make SIP Call with Tone <input type="radio"/> Stream Mic Audio <small> ⓘ "Play Tone" will play a recorded audio file to a local speaker and multicast if configured. "Stream Mic Audio" will stream microphone audio to multicast only, so it requires Multicast "Master" mode to be enabled in "Basic Settings > Multicast".</small>
Tone/Pre-recorded Announcement	<input type="text" value="chime.wav"/>
Tone Duration	<input checked="" type="radio"/> Play Once <input type="radio"/> Play While Held

 *Note: See "Additional Features Tab – Input/Output" section of this user doc for additional information on input device configuration*

Blue LED Indicator

This LED light is on during initialization, boot, or while active. Ring and Page modes, when active, will turn the LED on steady. If the optional Talkback mode, 'Two-way', is enabled, under **Basic Settings > Page Mode**, the LED will now flash instead (during a page event) to provide a clear indication that the microphone is active. The LED heartbeat option, when enabled, will flash the LED every 30 seconds as visual confirmation of PoE power and SIP server registration. LED configuration options can be found in **Additional Features > Input/Output**

Output	
Output Light	<input checked="" type="radio"/> Enabled <input type="radio"/> Disabled <small> ⓘ Disable the blue light on the speaker entirely (keep the light off even when the speaker is active)</small>
Heartbeat Light	<input type="radio"/> Enabled <input checked="" type="radio"/> Disabled <small> ⓘ Flash the blue light every 30 seconds to indicate that the speaker is powered and running.</small>
Output Relay	<input checked="" type="radio"/> Enabled <input type="radio"/> Disabled

Specifications

Power Input: 48V PoE IEEE 802.3af Class 0 (Max 12.95 W)
 or Type 2 PoE+ IEEE 802.3at (Max 25.5 W)
 Idle nominal 2W

SIP: Multiple extensions for Page or Alerting

Multicast: Receive

Audio Codecs: G.711 A-law, G.711 u-law, G.722, Polycom Group Page

Microphone: Electret omnidirectional wideband

Audio Delay: 10 to 1000 ms selectable for synchronization

Audio Memory: 1 GByte available

Relay Output: Normally open, activated when 8190 is in use
 Max 30 V 50 mA

Relay Input: Normally open or normally closed dry contact,
 Algo 1202 CallBox, Algo 1203 Wall Switch, EOL termination

Relay Input Current Draw Detection Thresholds:

	Active	Idle	Tamper
Normally Open	>4mA	<4mA	N/A
Normally Open with Supervision	>20mA	4-20mA	<4mA
Normally Closed	<4mA	>4mA	N/A
Normally Closed with supervision	4-20mA	>20mA	<4mA

Nominal 12V source, current limited to 40mA
 Typical supervision resistor value = 1k ohm

Configuration: Web interface or provisioning

Provisioning: TFTP, FTP, HTTP, HTTPS

Supervision: SNMP

NAT: STUN, CRLF Keep Alive

Processor:	Linux OS ARM Cortex-A8 32-Bit RISC Processor
Server Redundancy:	Primary, secondary, tertiary
Environmental:	32 to 104 °F (0 to + 40 °C); 10-95% RH non-condensing. Dry indoor locations only (Contact Algo for options for outdoor locations)
Compliance:	RoHS, CE, FCC Class A, CSA/UL (USA & Canada)

FCC Compliance Statement

This equipment has been tested and found to comply with the limits for a Class A digital device, pursuant to Part 15 of the FCC Rules. These limits are designed to provide reasonable protection against harmful interference when the equipment is operated in a commercial environment. This equipment generates, uses, and can radiate radio frequency energy, and if it is not installed and used in accordance with the instruction manual, it may cause harmful interference to radio communications. Operation of this equipment in a residential area is likely to cause harmful interference, in which case the user will be required to correct the interference at his own expense.