



NeoGate TA410/810

User Manual

Version 1.1

Date: Sept. 2, 2014

Yeastar Information Technology Co. Ltd

1. Preparation before Installation	4
2. Hardware Specifications.....	6
2.1 Overview	6
2.2 LED Indicators and Ports.....	7
2.3 Specifications and Operating Environment	9
3. NeoGate TG Series Installation	11
3.1 Placement Instructions	11
3.2 Installation Instructions.....	11
3.2.1 Connection of Ethernet Ports	11
3.2.2 Connection of GSM ports	11
3.2.3 Power Connection.....	12
3.2.4 Indicators Status.....	12
4. NeoGate TG Series Basic Configurations	13
4.1 Factory Defaults	13
4.2 Logging in the Web Configuration Panel	13
4.3 Network Settings	14
4.4 Make and Receive calls	15
4.5 Reset to Factory Defaults	15
5. Conclusion.....	15

About NeoGate TG Series VoIP GSM Gateway

NeoGate TG Series is a series of VoIP GSM gateway connecting GSM Network to VoIP Network directly, which can support two-way communication: GSM to VoIP or VoIP to GSM. It is the best solution ever to connect IP-based telephone systems, softswitches, and IP-PBXs to GSM network; and also the best fallback solution when landline goes down.

[NeoGate TG100](#) is a fully featured 1 port VoIP GSM gateway that provides GSM network connectivity for softswitch and IP PBX. It significantly reduces the costs of calls with two-way communication: VoIP to GSM and GSM to VoIP. With friendly GUI, everything can be easily set up.

[NeoGate TG200](#) is a VoIP GSM gateway with 2 channels providing GSM network connectivity for softswitch and IP PBX. It supports two-way communication: VoIP to GSM and GSM to VoIP. Thus the calls costs could be significantly reduced by VoIP or GSM network.

[NeoGate TG400](#) is a compact 4 channels VoIP GSM gateway that connects GSM network with VoIP. It is the ideal product for small and medium sized companies with heavy demands of calls to mobile networks. The cost-saving solution makes connection cheaper and efficient.

[NeoGate TG800](#) is a powerful VoIP GSM gateway with 8 channels, bridging between GSM network and IP-based systems. Designed to slash the cost of telephone calls, it can find the cheapest route and use the most economical SIM card.

[NeoGate TG1600](#) is a VoIP GSM gateway with 16 channels providing GSM network connectivity for softswitches and IP-PBXs. It supports two-way communication: VoIP to GSM and GSM to VoIP. Thus the calls costs could be significantly reduced by VoIP or GSM network.

This Guide explains how to install NeoGate TG Series Gateway, how to configure NeoGate TG Series Gateway via web interface, and how to insert SIM cards, etc.

1. Preparation before Installation

Please make sure the following devices are available before

installation:

Contents of the box

Upon receiving NeoGate gift box, please open the package and check if all the items are supplied as NeoGate TG100 Packing List (See Sheet 1), NeoGate TG200 Packing List (See Sheet 2), NeoGate TG400 Packing List (See Sheet 3), NeoGate TG800 Packing List (See Sheet 4), and NeoGate TG1600 Packing List (See Sheet 5). If there is any problem, please contact your equipment provider.

Item	Unit	QTY	Description
NeoGate TG100	PC	1	NeoGate TG100 main box
Power adaptor	PC	1	Power Supply
Warranty card	PC	1	With Series Number printed for Repair & Return
Antenna (short)	PC	1	

Sheet 1 NeoGate TG100 Packing List

Item	Unit	QTY	Description
NeoGate TG200	PC	1	NeoGate TG200 main box
Power cord	PC	1	For the input of power
Warranty card	PC	1	With Series Number printed for Repair & Return
Network cable	PC	1	
Antenna	PC	2	
Mounting ear	PC	3	
Screws	PC	9	9 screws ($\varnothing 3.0 \times 6\text{mm}$) for mounting ears
Grounding stud and nut	Pair	1	
Rubber feet	PC	4	

Sheet 2 NeoGate TG200 Packing List

Item	Unit	QTY	Description
NeoGate TG400	PC	1	NeoGate TG400 main box
Power cord	PC	1	For the input of power
Warranty card	PC	1	With Series Number printed for Repair & Return
Network cable	PC	1	
Antenna	PC	4	
Mounting ear	PC	3	
Screws	PC	9	9 screws ($\varnothing 3.0 \times 6\text{mm}$) for mounting ears

Grounding stud and nut	Pair	1	
Rubber feet	PC	4	

Sheet 3 NeoGate TG400 Packing List

Item	Unit	QTY	Description
NeoGate TG800	PC	1	NeoGate TG800 main box
Power cord	PC	1	For the input of power
Warranty card	PC	1	With Series Number printed for Repair & Return
Network cable	PC	1	
Antenna	PC	8	
Mounting ear	PC	2	
Screws	PC	8	8 screws ($\varnothing 3.0 \times 6\text{mm}$) for mounting ears
Grounding stud and nut	Pair	1	
Rubber feet	PC	4	

Sheet 4 NeoGate TG800 Packing List

Item	Unit	QTY	Description
NeoGate TG1600	PC	1	NeoGate TG1600 main box
Power cord	PC	1	For the input of power
Warranty card	PC	1	With Series Number printed for Repair & Return
Network cable	PC	1	
Antenna	PC	4 or 16	4 antennas for TG1600 that supports antenna splitter
Mounting ear	PC	2	
Screws	PC	8	8 screws ($\varnothing 3.0 \times 6\text{mm}$) for mounting ears
Grounding stud and nut	Pair	1	
Rubber feet	PC	4	

Sheet 5 NeoGate TG1600 Packing List

2. Hardware Specifications

2.1 Overview



Figure 2-1 NeoGate TG Series



Figure 2-2 NeoGate TG1600

2.2 LED Indicators and Ports

The LED indicators and ports of NeoGate TG Series are straightforward. Take the front panel and rear panel of NeoGate TG400 and TG1600 as an example.

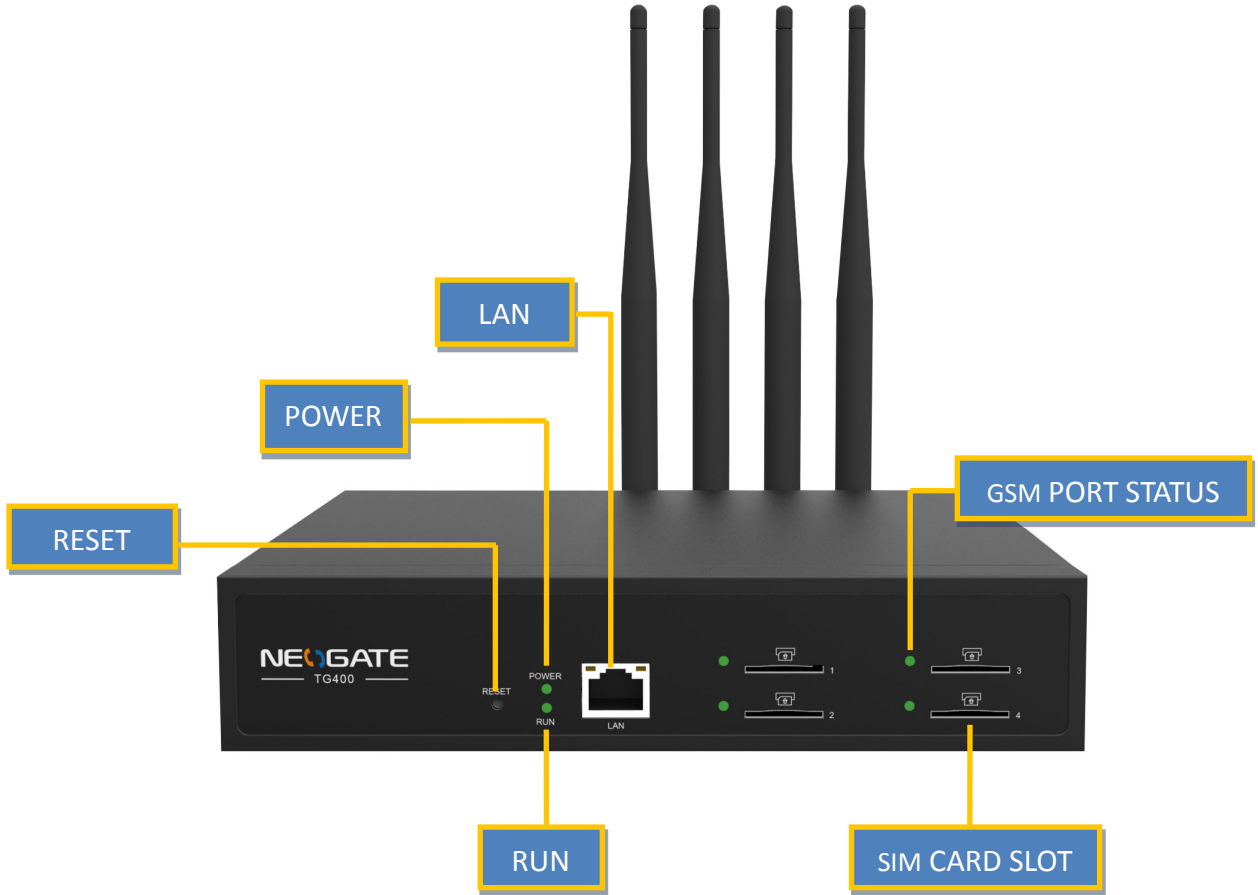

Figure 2-3 NeoGate TG400 Front Panel

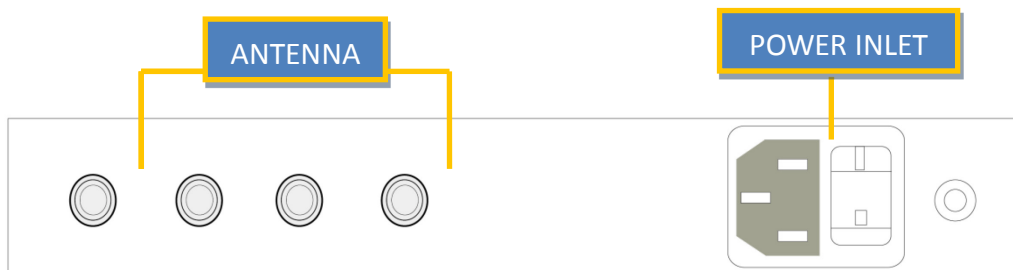

Figure 2-4 NeoGate TG400 Rear Panel

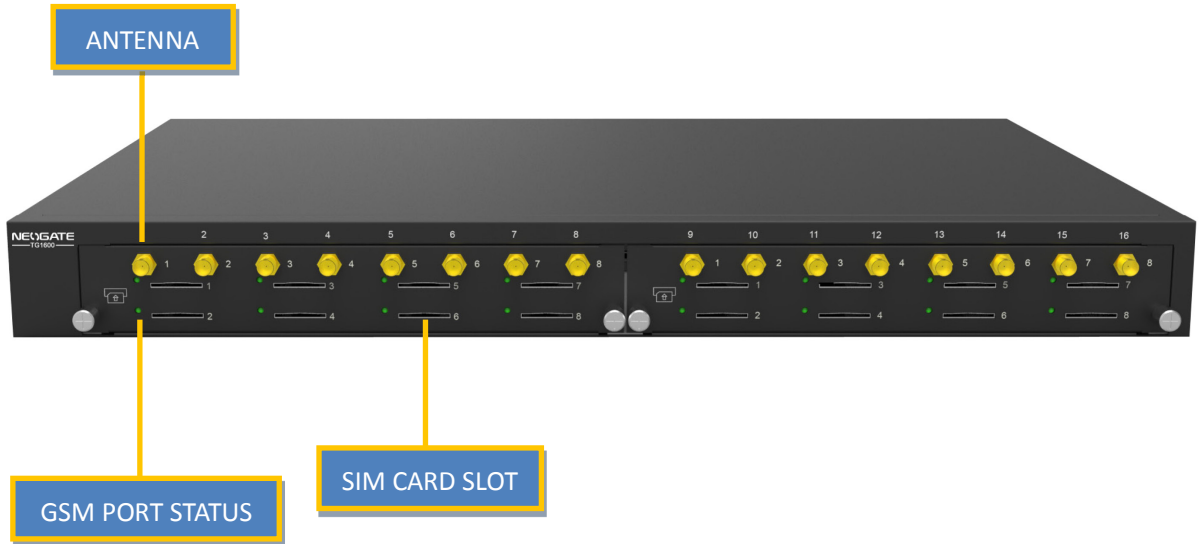



Figure 2-5 NeoGate TG1600 Front Panel



Figure 2-6 NeoGate TG1600 Rear Panel

LED	Indication	Status	Description
Power	Power status	On	The power is switched on.
		Off	The power is switched off.
RUN	NeoGate status	Blinking	NeoGate is running properly.
		Not Blinking/Off	NeoGate goes wrong.

1-16	GSM port status	Green light	<p>The green light is solid green: the port is working properly.</p> <p>The green light is blinking: there is an ongoing call on the port.</p> <p>The green light is off: no SIM card is detected or the port is not working properly.</p>
------	-----------------	-------------	--

Ports	Description
Antenna ports	For the connection of GSM Antennas.
Ethernet ports	NeoGate TG Series provides 1 10/100 adaptive RJ45 Ethernet ports, marked as LAN. -LAN port: LAN port is for the connection to Local Area Network (LAN).
Reset button	<p>Press the reset button to restore the factory defaults.</p> <p> Please make sure that you want to reset, because once reset the previous configurations would be erased automatically.</p>
Power inlet	For the connection of a power adapter.
Console port (TG800 and TG1600)	For debugging.

2.3 Specifications and Operating Environment

TG100	Description
Size (L×W×H)	110×70×24 (mm)
Power Supply	AC 100~240V/50~60Hz (DC 12V, 1A)
Operating Temperature	0°C–40°C (32°F–104°F)
Storage Temperature	-20°C–65°C (-4°F–149°F)
Humidity	10%~90% (Non-condensing)

TG200/TG400	Description
Size (L×W×H)	213×160×44 (mm)
Power Supply	100-240V 50/60Hz 0.5A MAX
Operating Temperature	0°C–40°C (32°F–104°F)
Storage Temperature	-20°C–65°C (-4°F–149°F)
Humidity	10%~90% (Non-condensing)

TG800	Description
Size (L×W×H)	340×210×44 (mm)
Power Supply	100-240V 50/60Hz 1.5A MAX
Operating Temperature	0°C–40°C (32°F–104°F)
Storage Temperature	-20°C–65°C (-4°F–149°F)
Humidity	10%~90% (Non-condensing)

TG1600	Description
--------	-------------

Size (L×W×H)	440x280x44 (mm)
Power Supply	100-240V 50/60Hz
Operating Temperature	0°C–40°C (32°F–104°F)
Storage Temperature	-20°C–65°C (-4°F–149°F)
Humidity	10%–90% (Non-condensing)

3. NeoGate TG Series Installation

i To avoid unexpected accident, personal injury or device damage, please read the following instructions before installing NeoGate TG Series Gateway.

3.1 Placement Instructions

- ◆ Ambient Temperature: to avoid overheating, please do not run NeoGate TG Series in the place where the ambient temperature is above 104°F (40°C).
- ◆ Ventilation: please make sure that the device has good ventilation around.
- ◆ Anti-jamming: there may be some sources of interference that might affect the normal running of NeoGate. It's highly recommended that the device
 - Should be placed away from high-power radio, radar transmitters and high frequency, and high-current devices.
 - Is using independent power junction box and effective anti-grid interference measures have been taken.
- ◆ Mechanical load: Please make sure that the device is placed steadily to avoid any accident that might cause damage. If placed on the desktop, please ensure it is horizontally placed.
- ◆ Radio frequency: because of the radio frequency, please put the device at least 50 cm away from human body.

3.2 Installation Instructions

After placing NeoGate in a suitable place, please connect the power adapter and all other cables to complete the installation.

3.2.1 Connection of Ethernet Ports

NeoGate TG Series provides one 10/100M adaptive RJ45 Ethernet LAN port.

- ◆ LAN Port Connection
Connect one end of a network cable to the LAN port of NeoGate, and the other end to any port of company's LAN switch/router.

i If the LAN port is connected to PC directly (not via a switch), please use cross-over cable.

3.2.2 Connection of GSM ports

NeoGate TG Series, available with four models, supports 1, 2, 4, 8, 16 GSM ports. To use the GSM ports, you need to insert the SIM card and connect the antenna.

1. Connect the antenna.
Connect the antenna to the relevant place.
2. Insert SIM cards.
Push the SIM card into the card slot on the front panel.

3.2.3 Power Connection

Once users have made sure that device installation, cable connection and power type are correct, please switch on the power. Then NeoGate will start booting. In the meantime, users would see that the “POWER” and “RUN” indicator lights turn on.

 Please switch off the power before plugging or unplugging the cables.

3.2.4 Indicators Status

When power is connected, users should be able to find that the “Power” indicator, “RUN” indicator, and GSM port status indicator beside the slot that has installed SIM cards turn on.

4. NeoGate TG Series Basic Configurations

4.1 Factory Defaults

NeoGate TG Series provides web-based configuration interface for administrator and account user. The user can manage the device by logging in the Web interface.

The factory default IP address:
LAN: 192.168.5.150;
Access path: http://[IP address]
User Name: admin;
Password: password
Default SIP UDP port: 5060

4.2 Logging in the Web Configuration Panel

Firstly, please check if the IP address that assigned to the network port (LAN) is in the same segment with the PC and which can be connected when commit “Ping + NeoGate IP address” command. Start the browser on PC. In the address bar, enter the IP address, click “Enter” button and then you can see NeoGate Web Configuration Panel login page (See Figure 4-1).

VoIP GSM Gateway for Cost Reduction

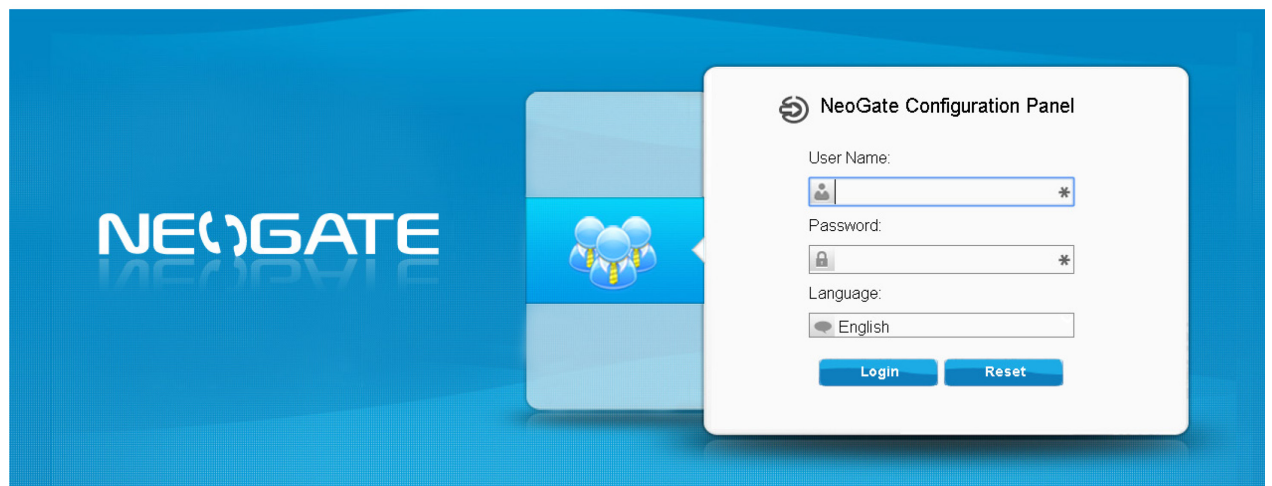

Copyright © 2006-2014 Yeastar Technology Co., Ltd. All Rights Reserved.

Figure 4-1 NeoGate Web Configuration Panel Login Page

Enter the Admin User Name and Password to log in.

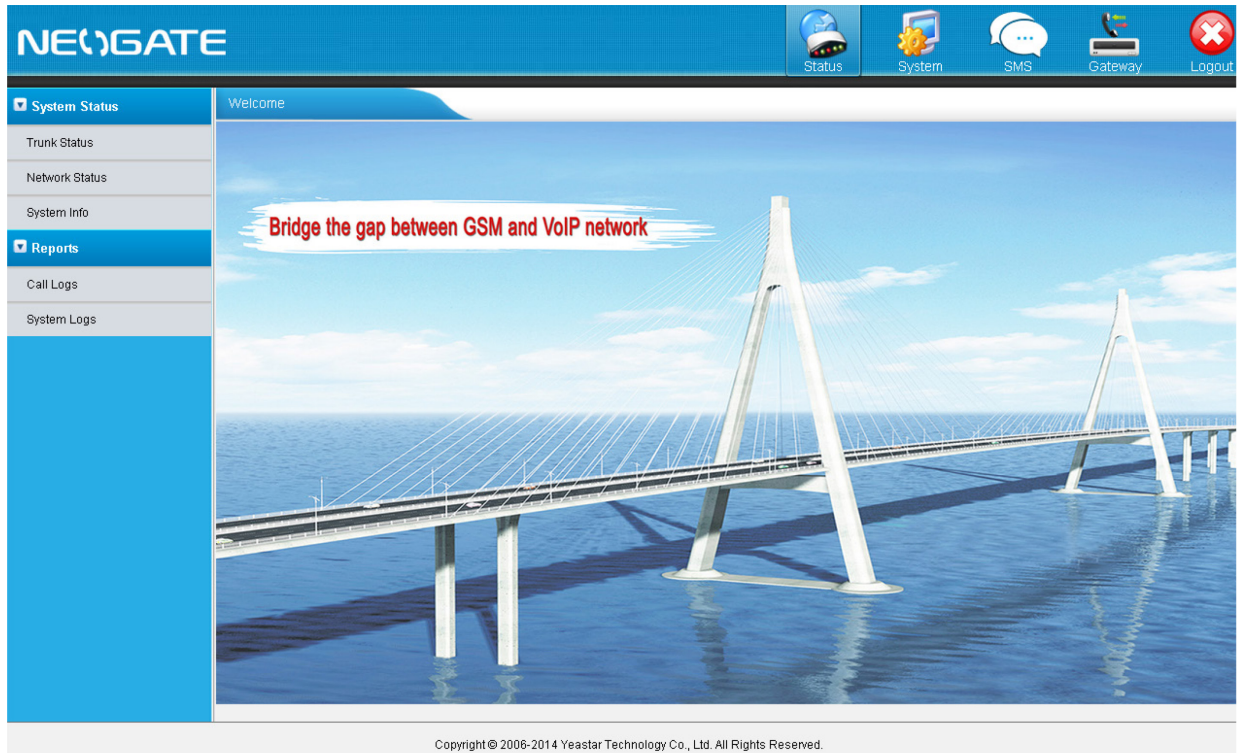

Figure 4-2 NeoGate Admin Configuration Interface

Via the configuration interface, the admin can make all the system configurations, including network settings (LAN, Firewall, VPN, DDNS, VLAN, etc.); system parameters configuration (time zone, password, etc.); internal settings (Web access port, etc.); route lists; module lists; call logs (search, download); firmware update and reset, etc.

i Please note that after saving the changes, remember to click the “Apply Changes” button to make the changes take effect.

4.3 Network Settings

After logging in the admin configuration interface, generally the first step is to configure the IP address. If the LAN ports are connected to the network, their IP addresses need to be configured. If not, just configuring the IP address of the LAN port which is connected to the local area network of the company is OK.

◆ LAN Settings

Click “Network Preferences”->“LAN Settings” on the left menu bar of the web configuration interface. LAN port is used for the interoperability of IP terminals and NeoGate. If the LAN port is connected to the company’s LAN, please configure the correct IP address and corresponding subnet mask.

i Please note that after changing the IP address of LAN port, NeoGate should be rebooted to make the new changes taking effect.

4.4 Make and Receive calls

NeoGate TG Series supports SIP Peer mode. Users should be able to make and receive calls after configuring VoIP trunking, and Mobile to IP or IP to Mobile routes. Please refer to Administrator's Guide for details.

4.5 Reset to Factory Defaults

If you forget the new IP address or the password of admin, or in other cases that you would like to restore the factory defaults, please reset the device following the below instructions: Please press the "RESET" button located in the back panel with a paper clip or a pencil tip. You can see the RUN indicator stops flicker and turns solid. When the RUN indicator turns off, the button could be released and system begins to reset. During the process, please do not power off until the RUN indicator become normal which means the reset process is completed.

 Note: After resetting, all the configurations made by the admin would be erased.

5. Conclusion

This Installation Guide only explains the installation and basic settings of NeoGate TG Series. For more functionality and advanced settings of NeoGate TG Series, please refer to the relative documents as below:

"NeoGate TG Series Datasheet"

"NeoGate TG Series Administrator's Guide"

[The End]

