

Grandstream Networks, Inc.

GDS3710 - Hemispheric HD IP Video Door System

User Manual



COPYRIGHT

©2016 Grandstream Networks, Inc. <http://www.grandstream.com>

All rights reserved. Information in this document is subject to change without notice. Reproduction or transmittal of the entire or any part, in any form or by any means, electronic or print, for any purpose without the express written permission of Grandstream Networks, Inc. is not permitted.

The latest electronic version of this user manual is available for download here:

<http://www.grandstream.com/support>

Grandstream is a registered trademark and Grandstream logo is trademark of Grandstream Networks, Inc. in the United States, Europe and other countries.

CAUTION

Changes or modifications to this product not expressly approved by Grandstream, or operation of this product in any way other than as detailed by this User Manual, could void your manufacturer warranty.

WARNING

Please do not use a different power adaptor with your devices as it may cause damage to the products and void the manufacturer warranty.



GNU GPL INFORMATION

GDS3710 firmware contains third-party software licensed under the GNU General Public License (GPL). Grandstream uses software under the specific terms of the GPL. Please see the GNU General Public License (GPL) for the exact terms and conditions of the license.

Grandstream GNU GPL related source code can be downloaded from Grandstream web site from:
<http://www.grandstream.com/support/faq/gnu-general-public-license/gnu-gpl-information-download>



Table of Contents

DOCUMENT PURPOSE	10
CHANGE LOG	11
Firmware Version 1.0.1.19.....	11
WELCOME	12
PRODUCT OVERVIEW	13
Feature Highlights.....	13
Technical Specifications.....	13
GETTING STARTED	16
Equipment Packaging.....	16
Description of the GDS3710	17
Connecting and setting up the GDS3710	17
GDS3710 Wiring Connection.....	18
GDS3710 Back Cover Connections	19
Connection Example.....	20
GETTING TO KNOW GDS3710	22
Connecting GDS3710 to Network with DHCP Server	22
<i>Windows Platform</i>	22
UPnP.....	22
GDS Manager Utility Tool.....	23
<i>Apple Platform</i>	25
Connect to the GDS3710 using Static IP.....	27
GDS3710 APPLICATION SCENARIOS	28
Peering Mode without SIP Server.....	28
Peering Using SIP Server (UCM6XXX).....	28
Using a Network Video Recorder (GVR355X).....	29
Peripheral Connections of GDS3710.....	30



<i>Alarm IN/OUT</i>	32
<i>Protection Diode</i>	32
Connection Examples	33
<i>Wiring Sample using 3rd Party Power Supply</i>	34
<i>Wiring Sample using Power Supply for both GDS3710 and Electric Strike</i>	34
<i>Wiring Sample using PoE to power GDS3710 and 3rd Party Power Supply for Electric Strike</i>	35
<i>Good Wiring Sample for Electric Strike and High Power Device</i>	36
Wiegand Module Wiring Examples	36
<i>Input example with 3rd party power supply for Wiegand device</i>	37
<i>Input example with power supply for both GDS3710 and Wiegand Device</i>	37
<i>Output example with 3rd party power supply for Wiegand device</i>	38
<i>Wiegand RFID Card Reader Example</i>	38
GDS3710 HOME WEB PAGE	39
GDS3710 Configuration & Language Page.....	40
GDS3710 SETTINGS	41
Live View Page	41
Door System Settings	41
<i>Basic Settings</i>	42
<i>Card Management</i>	44
<i>Add Users Manually</i>	45
<i>Add Users Automatically</i>	46
System Settings	47
<i>Date & Time Settings</i>	47
<i>Basic Settings</i>	48
<i>Access Settings</i>	49
<i>User Management</i>	50
SIP Settings	50
<i>SIP Basic Settings</i>	50
<i>SIP Advanced Settings</i>	51
<i>White List</i>	53
Video & Audio Settings	54



<i>Video Settings</i>	54
<i>OSD Settings</i>	56
<i>CMOS Settings</i>	57
<i>Audio Settings</i>	57
Alarm Config	58
<i>Alarm Events Config</i>	58
<i>Motion Detection</i>	60
<i>Digital Input</i>	61
<i>Alarm Output</i>	61
<i>Hostage Code</i>	61
<i>Tamper Alarm</i>	62
<i>Keypad Input Error Alarm</i>	62
<i>Alarm Schedule</i>	62
<i>Alarm Action</i>	63
<i>Alarm Phone List</i>	65
Email & FTP Settings	66
<i>Email Settings</i>	66
<i>FTP & Center Storage</i>	67
Maintenance Settings	68
<i>Upgrade</i>	68
<i>Reboot & Reset</i>	69
<i>Debug Log</i>	69
<i>Data Maintenance</i>	70
Status	71
<i>System Info</i>	71
<i>Network Info</i>	72
EXPERIENCING THE GDS3710	74



Table of Tables

Table 1: GDS3710 Features in a Glance	13
Table 2: GDS3710 Technical Specifications	13
Table 3: Equipment Packaging	16
Table 4: GDS3710 Wiring Connection	18
Table 5: Home Page Description	39
Table 6: Door System Settings.....	43
Table 7: Card Info.....	46
Table 8: Date & Time.....	47
Table 9: Basic Settings.....	48
Table 10: Access Settings	49
Table 11: User Management	50
Table 12: SIP Basic Settings.....	51
Table 13: SIP Advanced Settings.....	52
Table 14: White List.....	53
Table 15: Video Settings	55
Table 16: OSD Settings.....	56
Table 17: CMOS Settings.....	57
Table 18: Audio Settings.....	58
Table 19: Motion Detection.....	60
Table 20: Digital Input.....	61
Table 21: Hostage Code Alarm	61
Table 22: Tamper Alarm	62
Table 23: Keypad Input Error Alarm	62
Table 24: Alarm Actions.....	64
Table 25: Alarm Phone List	65
Table 26: Email Settings - SMTP	66
Table 27: FTP.....	67
Table 28: Upgrade.....	68
Table 29: Reset & Reboot	69
Table 30: System Info.....	72
Table 31: Network Info	73



Table of Figures

Figure 1: GDS3710 Package	16
Figure 2: GDS3710 Front View	17
Figure 3: GDS3710 Back View	17
Figure 4: GDS3710 Back Cover Connections	19
Figure 5: GDS3710 Back Cover	20
Figure 6: Connection Example.....	20
Figure 7: Powering the GDS3710	21
Figure 8: Detecting GDS3710 via UPnP	23
Figure 9: GDS3710 Login Page.....	23
Figure 10: GDS3710 Detection.....	24
Figure 11: Apple Safari Settings Page	25
Figure 12: Bonjour Setting Page.....	25
Figure 13: MJPEG Stream.....	26
Figure 14: Static IP on Windows.....	27
Figure 15: Peering GDS3710 With UCM6XXX.....	29
Figure 16: Peering GDS3710 With GVR3550.....	30
Figure 17: Peripheral Connections for GDS3710	31
Figure 18: Alarm_In/Out Circuit for GDS3710.....	32
Figure 19: Example 1	33
Figure 20: Example 2.....	33
Figure 21: 3rd Party Power Supply Wiring Sample	34
Figure 22: Power Supply Used for Both GDS3710 and Electric Strike	34
Figure 23: Wiring Sample Using PoE to power GDS3710 and 3rd Party Power supply for Electric Strike	35
Figure 24: Example to Avoid When Powering the Electric Strike	35
Figure 25: Electric Strike and High Power Device Example	36
Figure 26: Wiegand Input Example with 3rd Party Power Supply	37
Figure 27: Wiegand Input Example with Power Supply for GDS3710 and Wiegand Device	37
Figure 28: Wiegand Output Wiring Example.....	38
Figure 29: Wiegand RFID Card Reader Example	38
Figure 30: Home Page.....	39
Figure 31: Switch Language Page.....	40
Figure 32: Live View Page	41
Figure 33: Door System Settings Page.....	42
Figure 34: Card Management	45
Figure 35: Card Info	45
Figure 36: Date & Time Page.....	47
Figure 37: Basic Settings Page.....	48
Figure 38: Access Settings Page	49
Figure 39: User Management Page.....	50



Figure 40: SIP Basic Settings Page	50
Figure 41: SIP Advanced Settings Page	52
Figure 42: White List Page	53
Figure 43: Video Settings Page	54
Figure 44: OSD Settings Page	56
Figure 45: CMOS Settings Page	57
Figure 46: Audio Settings Page	58
Figure 47: Events Page	59
Figure 48: Region Config	60
Figure 49: Digital Input	61
Figure 50: Alarm Schedule	62
Figure 51: Edit Schedule	63
Figure 52: Alarm Action	64
Figure 53: Edit Alarm Action	64
Figure 54: Alarm Phone List	65
Figure 55: Email Settings - SMTP Page	66
Figure 56: Picture Storage Settings	67
Figure 57: Upgrade Page	68
Figure 58: Reset & Reboot Page	69
Figure 59: Debug Log Page	70
Figure 60: Data Maintenance Page	71
Figure 61: System Info Page	72
Figure 62: Network Info Page	73



DOCUMENT PURPOSE

This document describes the basic concept and tasks necessary to use and configure your GDS3710. And it covers the topic of connecting and configuring the GDS3710, making basic operations and the call features. Please visit <http://www.grandstream.com/support> to download the latest “GDS3710 User Manual”.

This guide covers following topics:

- [Product Overview](#)
- [Getting Started](#)
- [Getting to Know gds3710](#)
- [GDS3710 Application Scenarios](#)
- [GDS3710 Home Web Page](#)
- [GDS3710 Settings](#)
- [Experiencing the GDS3710](#)



CHANGE LOG

This section documents significant changes from previous versions of user guide for GDS3710. Only major new features or major document updates are listed here. Minor updates for corrections or editing are not documented here.

Firmware Version 1.0.1.19

- This is the initial version for GDS3710.



WELCOME

Thank you for purchasing Grandstream's GDS3710 Hemispheric HD IP Video Door System, an innovative IP based powerful video door system.

GDS3710 HD IP Video Door System is a hemispheric IP video door phone and a high-definition IP surveillance camera. GDS3710 is ideal for monitoring from wall to wall without blind spots. Powered by an advanced Image Sensor Processor (ISP) and state of the art image algorithms, it delivers exceptional performance in all lighting conditions. The GDS3710 IP video door system features industry-leading SIP/VoIP for 2-way audio and video streaming to smart phones and SIP phones. It contains integrated PoE, LEDs, HD loudspeaker, RFID card reader, motion detector, lighting control switch and more.

GDS3710 HD IP Video Door System can be managed by Grandstream's free window based management software: GDS Management Software, a client/server based software which provided RFID card management and basic reports for the door entrance.

Along with Grandstream videophone, mobile Apps, and Network Video Recorder (NVR), the GDS3710 provides a powerful recording and monitoring solution. It can be managed with GSURF Pro or any ONVIF-compliant video management system. It also offers a flexible HTTP API for easy integration with 3rd party applications and other surveillance systems.

GDS3710 is ideal for entry places requiring a wide-angle monitoring, such as banks, hotels, schools, office building, retail stores and small warehouses, and for small to medium sized enclosed environments.



PRODUCT OVERVIEW

Feature Highlights

The following table contain the major features of the GDS3710.

Table 1: GDS3710 Features in a Glance

	<ul style="list-style-type: none"> • High-performance streaming server allowing multiple simultaneous streaming session accesses. • 2 Megapixel Progressive Scan CMOS, 1920H x 1080V. • Broad interoperability with most 3rd party SIP/VoIP devices and leading SIP/NGN/IMS platforms. • 2 Channels Input/Output alarm. • RS485, Wiegand Input and Output. • RFID card reader. • Weather proof, vandal resistant.
---	---

Technical Specifications

The following table resumes all the technical specifications including the protocols / standards supported, voice codecs, telephony features and upgrade/provisioning settings for GDS3710.

Table 2: GDS3710 Technical Specifications

Video Compression	H.264 High Profile / Main Profile / Base Profile, Motion JPEG
Image Sensor Resolution	1/2.7", 2 Megapixel, 1920H x 1080V
Lens Type	1/2", F2.5, FOV: 180°(W) x 150°(H)
Day & Night Mode	White LEDs with smart brightness control
Max Video Resolution	1920x1080
Max Frame Rate	30 frames per second
Minimum Illumination	0.5Lux
Wide Dynamic Range	Yes, up to 120dB
Embedded Analytics	Motion detection
Snapshots	Triggered upon events, sent via email and/or FTP
Multi-stream Resolution	High-performance streaming server allowing multiple simultaneous accesses: <ul style="list-style-type: none"> • Primary video stream: 1920 x 1080 resolution for continuous full HD recording



	<ul style="list-style-type: none"> • Secondary video stream: 640 x 480 resolution for SIP/VoIP video calls • Third video stream: 320 x 240 resolution for smartphone Apps
Network Protocols	TCP/IP/UDP, RTP/RTCP, HTTP/HTTPS local upload and mass provisioning using TR-069 (pending), ARP/RARP, ICMP, DNS (A record, SRV, NAPTR), DHCP, SSH, SMTP, TFTP, NTP, STUN, TLS, SRTP
SIP/VoIP Support	Broad interoperability with most 3rd party SIP/VoIP devices and leading SIP/NGN/IMS platforms
Voice Codecs	G.711 μ /a-law, G.722, in-band and out-of-band DTMF (in audio, RFC2833, SIP INFO), AEC
QoS	Layer 2 QoS (802.1Q, 802.1P) and Layer 3 QoS (ToS, DiffServ, MPLS)
Security	User and administrator level access control (pending), MD5 and MD5-sess based authentication, 256-bit AES encrypted configuration file, TLS, SRTP, HTTPS, 802.1x media access control
Upgrade / Provisioning	Firmware upgrade via TFTP/HTTP/HTTPS, mass provisioning using TR-069 (Pending) or AES encrypted XML configuration file
Audio Input	Built-in Digital Microphone, up to 1.5m with AEC
Audio Output	Built-in HD Loudspeaker, sound quality suitable for up to 3 m
Keypad / Buttons	12-key touchpad plus a capacitive doorbell button, each with individual LED illumination
RFID	125KHz: EM4100 (1 RFID card and 1 RFID key fob included)
Alarm Input	Yes, 2 channels, Vin < 15V, for door sensor or other devices
Alarm Output	Yes, 2 channels, 125VAC/0.5A, 30VDC/2A, Normal Open or Normal Close, for electric lock, light switch or other devices
Network Interface	10M/100M auto-sensing
Expansion Interface	RS485, Wiegand input and output
Dimensions (H x W x D) and Weight	173mm(H) x 80mm(W) x 36mm(D) 0.6 Kg
Power Supply	PoE (Power over Ethernet) IEEE 802.3af Class 3, or 12VDC/1A connection (AC power adapter not included)
Interoperability	ONVIF (Profile S) (pending)
Ingress Protection	Weather proof, vandal resistant, with support for extra back reinforcing metal plate
Temperature and Humidity	Operation: -30°C to 60°C (-22°F to 140°F) Storage: -35°C to 60°C (-31°F to 140°F) Humidity: 10% to 90% Non-condensing
Protection Class	IP66 (EN60529), IK09 (IEC62262)



Compliance

FCC: Part 15 subpart B Class B; Part 15 C; MPE

CE: EN 55032 Class B; EN 61000-3-2; EN 61000-3-3; EN 50130; EN 60950-1; EN 300330; EN 301489; EN 62311

RCM: AS/NZS CISPR 22; AS/NZS 4268; AS/NZS 60950.1

IC: ICES-003; RSS310



GETTING STARTED

This chapter provides basic installation instructions including the list of the packaging contents and information for obtaining the best performance using the GDS3710 Video Door System.

Equipment Packaging

Table 3: Equipment Packaging

GDS3710	
<ul style="list-style-type: none"> • 1 x GDS3710 • 1 x Installation Bracket • 1 x Frame Back Cover • 1 x Wiegand Cable • 1 x Drilling Template • 4 x Bracket Screws and Anchors • 3 x Rubber Gaskets (for sealing the back cable) 	<ul style="list-style-type: none"> • 6 x Back Panel Screws • 4 x Anti-tamper screws • 1 x Anti-Tamper Hex Key • 1 x RFID Card • 1 x Key Fob (more can be purchased from Partner/reseller) • 1 x Quick Installation Guide • 1 x GPL License

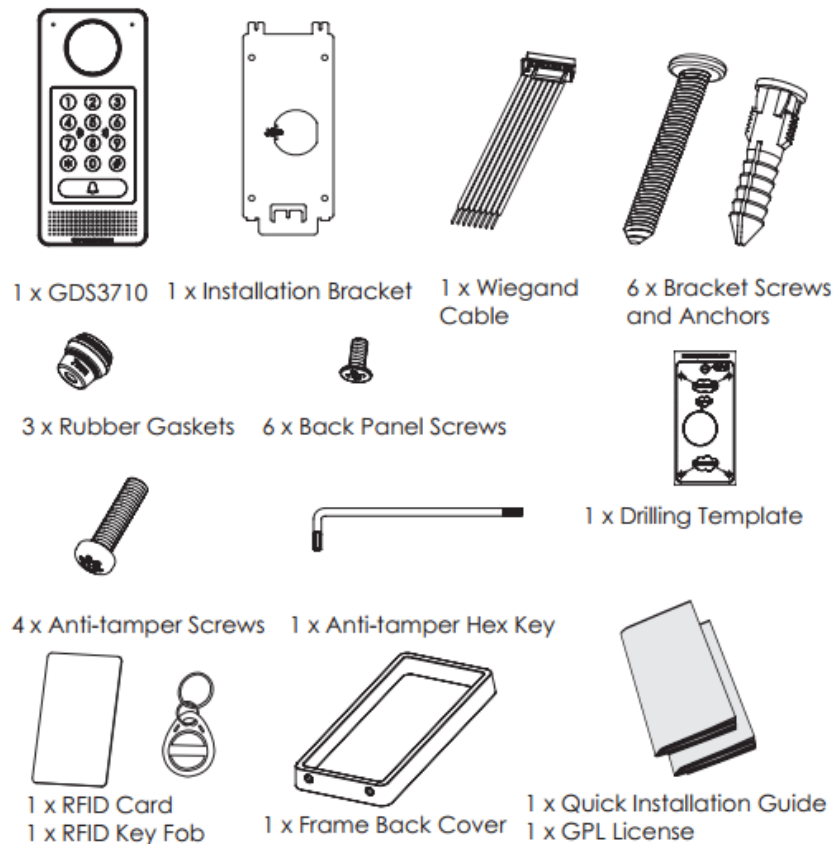

Figure 1: GDS3710 Package

Note: Check the package before installation. If you find anything missing, contact your system administrator

Description of the GDS3710

Below figures show the component of the back and front view of GDS3710 IP Video Door System:

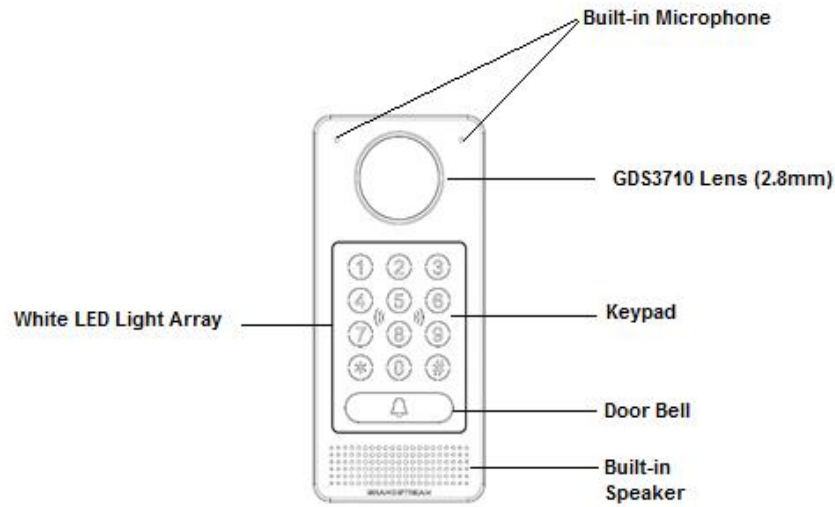

Figure 2: GDS3710 Front View

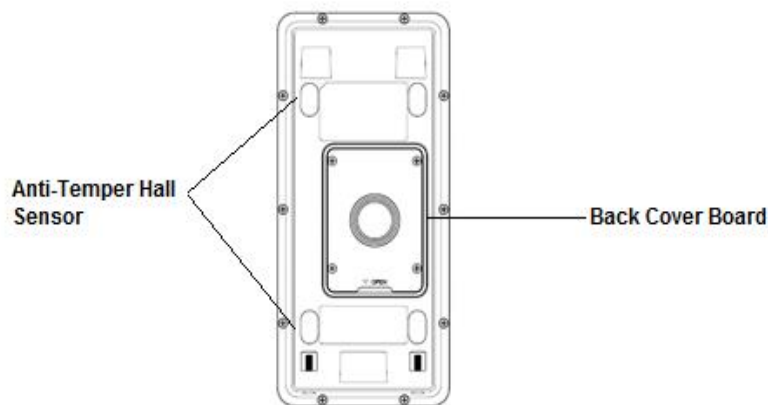

Figure 3: GDS3710 Back View

Connecting and setting up the GDS3710

The GDS3710 can be powered using PoE or PSU:

Using PoE as power supply (Suggested)

- Connect the other end of the RJ45 cable to the PoE switch.
- PoE injector can be used if PoE switch is not available.

Using the power adapter as power supply (PSU not provided)

- Connect the other end of the RJ45 cable to network switch or router.
- Connect DC 12V power source via related cable to the corrected PIN of the GDS3710.

GDS3710 Wiring Connection

Table 4: GDS3710 Wiring Connection

Jack	Pin	Signal	Function	Note	
J2 (Basic) 3.81mm	1	TX+	Ethernet PoE 802.3af Class 3, 12.95W	Orange / White	Data
	2	TX-		Orange	
	3	RX+		Green / White	
	4	RX-		Green	
	5	PoE_SP2	Class 3, 12.95W	Blue + Blue/White	Please twist these two wires together and connect to SP1, SP2 respectively even the PoE NOT used.
	6	PoE_SP1		Brown + Brown/White	
	7	RS485_B	RS485		
	8	RS485_A			
	9	GND	Power Supply		DC 12V, 1A Minimum
	10	12V			
J3 (Advanced) 3.81mm	1	GND	Alarm GND		
	2	ALARM1_IN+	Alarm In	Vin<15V	
	3	ALARM1_IN-			
	4	ALARM2_IN+			
	5	ALARM2_IN-			
	6	NO1	Alarm Out	Relay: 30VDC/2A; 125VAC/0.5A	
	7	COM1			
	8	NO2	Electric Lock	For "Fail Secure" (Locked when Power Lost) Strike, connect COM2 & NO2 ; For "Fail Safe" (Open when No Power) Magnetic Lock, connect COM2 & NC2 . Relay: 30VDC/2A; 125VAC/0.5A	
	9	COM2			
	10	NC2			
J4 (Special) 2.0mm	1	GND	Wiegand Power GND	Black	Both Input and Output MUST be connected
	2	WG_D1_OUT	Wiegand Output	Orange	GDS3710 function as Output of Card Reader, Connect Pin 1, 2, 3
	3	WG_D0_OUT	Signal	Brown	
	4	LED	Wiegand Output LED Signal	Blue	For External Card Reader; Or GDS3710 as Receiver Only



	5	WG_D1_IN	Wiegand Input	White	For External Card Reader
	6	WG_D0_IN	Signal	Green	Connect Pin 1,4,5,6,7,8
	7	BEEP	Wiegand Output BEEP Signal	Yellow	For External Reader Only
	8	5V	Wiegand Power Output	Red	For External Card Reader Only. 12VDC powered External Card Reader must use own power source, can NOT use this Pin.

S3710 Back Cover Connections

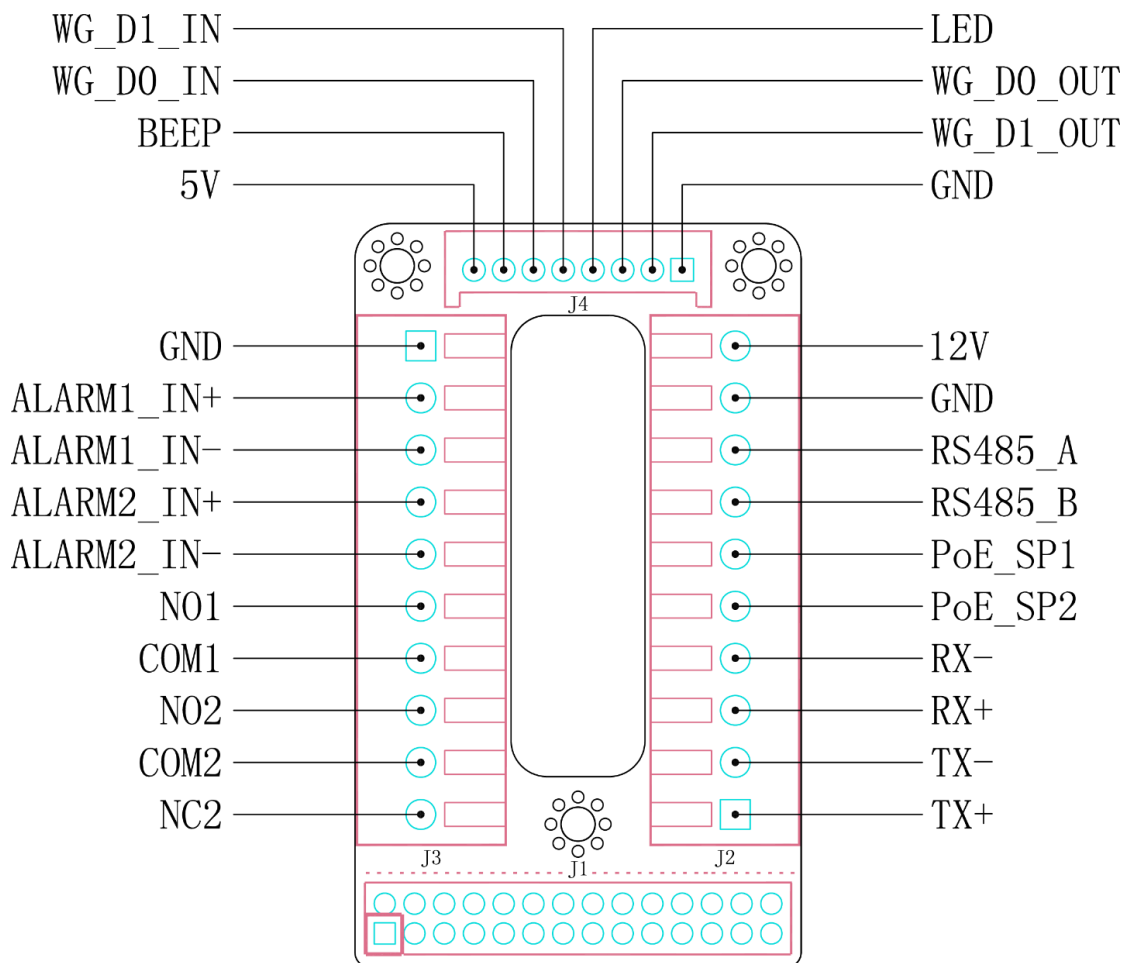

Figure 4: GDS3710 Back Cover Connections

Connection Example

To connect the GDS either by using PoE or PSU follow steps below:

- Open the Back-Cover Board of the GDS3710 which should look like following figure.

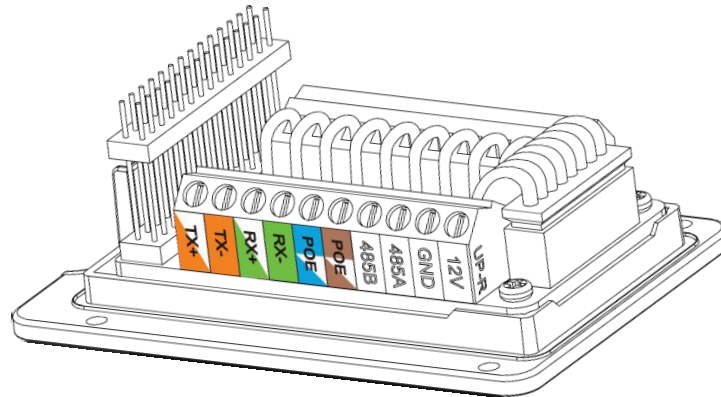

Figure 5: GDS3710 Back Cover

Power the unit using PoE

- Cut into the plastic sheath of your RJ45 cable, then Unwind and pair the colors like shown below.



Figure 6: Connection Example

- Connect each color of the RJ45 to its associate on the Back Cover of the GDS3710, this way user can power the unit using PoE.

Power the unit using PSU

- To power the unit using PSU, use a multimeter to detect the polarity of your Power Supply, then connect GND to negative pole and 12V to positive pole of the PSU.

Note: If the user doesn't have PoE switch, there is no need to connect the Blue and Brown wires to the GDS3710 since these wires are used to power the unit via Ethernet.

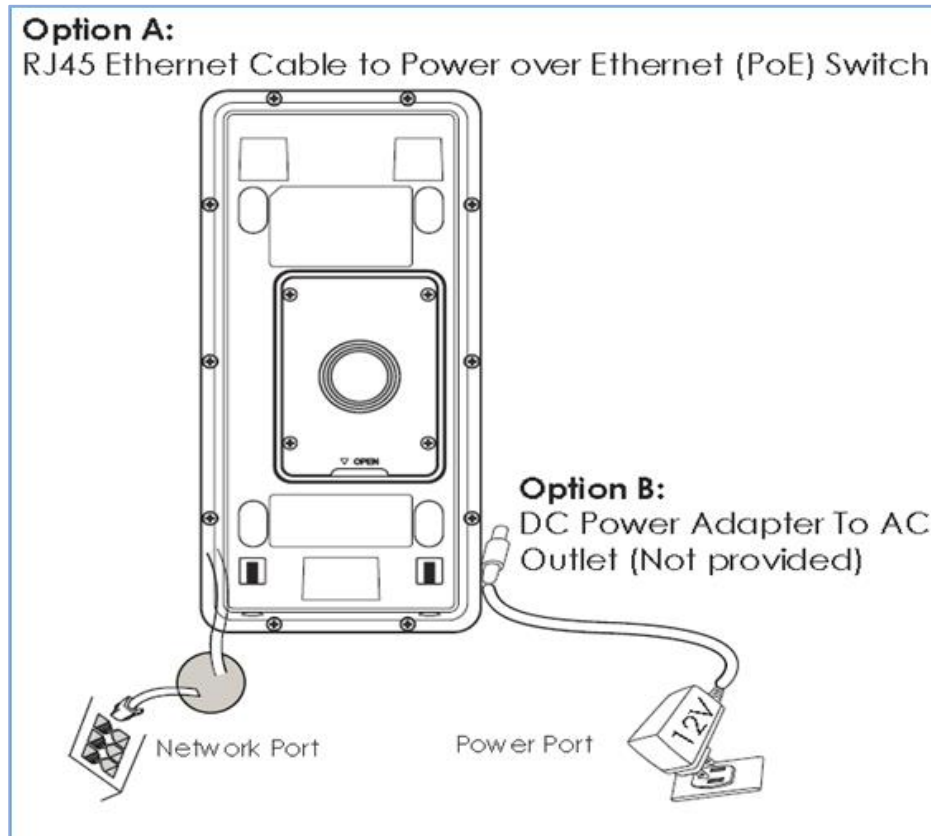

Figure 7: Powering the GDS3710

GETTING TO KNOW GDS3710

The GDS3710 has an embedded Web server to respond to HTTP GET/POST requests. Embedded HTML pages allow user to configure the GDS3710 through Microsoft Internet Explorer, or Firefox and Chrome (plug-in from Grandstream required).

1. Download WebControl Plug-in from the GDS3710 WebGUI

For Apple platform OS-X, only MJPEG video coded supported currently.

Notes:

- Please temporarily disable Antivirus or Internet Security Software when download and install the Grandstream WebControl Plug-in for Firefox/Chrome or “GSViewerX.cab” for Microsoft Internet Explorer. Please close Browser to install the downloaded Plug-in or Active-X.
- Please trust and install the file downloaded if prompted by the Antivirus or Security software.

Connecting GDS3710 to Network with DHCP Server

The GDS3710 by default has a DHCP client enabled, it will automatically get IP address from the network running DHCP server.

Windows Platform

Two ways exist for Windows user to get access to the GDS3710:

UPnP

By default, the GDS3710 has the UPnP feature turned ON. For customers using Windows network with UPnP turned on (most SOHO router support UPnP), it is very easy to access the GDS3710:

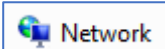
1. Find the “Network” icon  on the windows Desktop.
2. Click the icon to get into the “Network”, the GDS3710s will list as “Other Devices” shown like below.
Refresh the pages if nothing displayed. Otherwise, the UPnP may not active in the network.



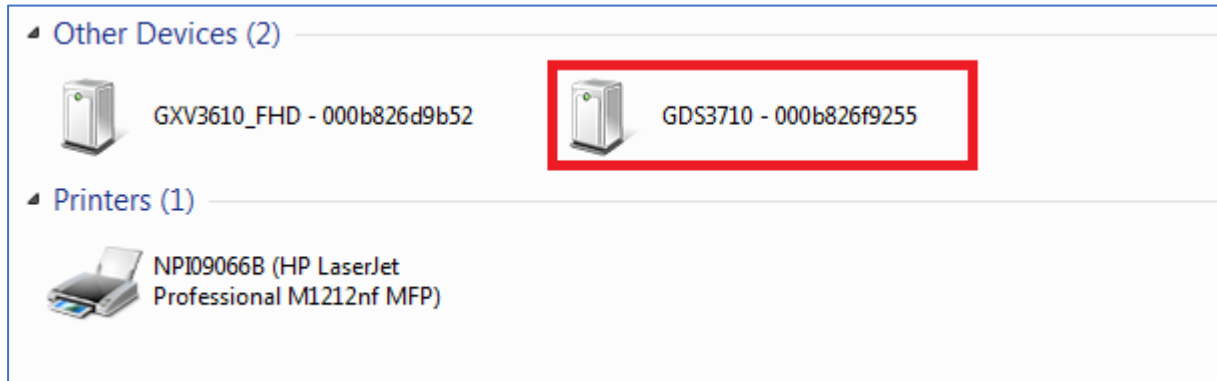

Figure 8: Detecting GDS3710 via UPnP

3. Click the displayed icon of related GDS3710, the default browser (e.g.: Firefox or Chrome) will open and connect directly to the login webpage.



Figure 9: GDS3710 Login Page

4. Once log in, the prompt message will display asking for plug-in installation.
5. Disable security or antivirus software, download and install the plug-in, close and open the browser again, the embedded video will be displayed if clicking the "LiveView" and click the stream number.

GDS Manager Utility Tool

User can know the IP address assigned to the GDS3710 from DHCP server log or using the Grandstream GDS Manager after installing this free utility tool provided by Grandstream. Below user can find instructions for using "GDS Manager" utility tool:



1. Download the GDS Manager utility tool from Grandstream website:
2. Install and run the Grandstream GDS Manager, a client/server architecture application, the server should be running first, then GDSManager (client) after:

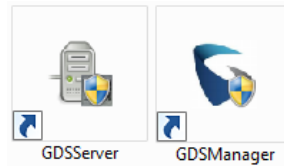

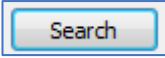
3. Click on the  tab on the left side of “Function Navigation” panel to begin device detection
4. The detected devices will appear in the output field like below:

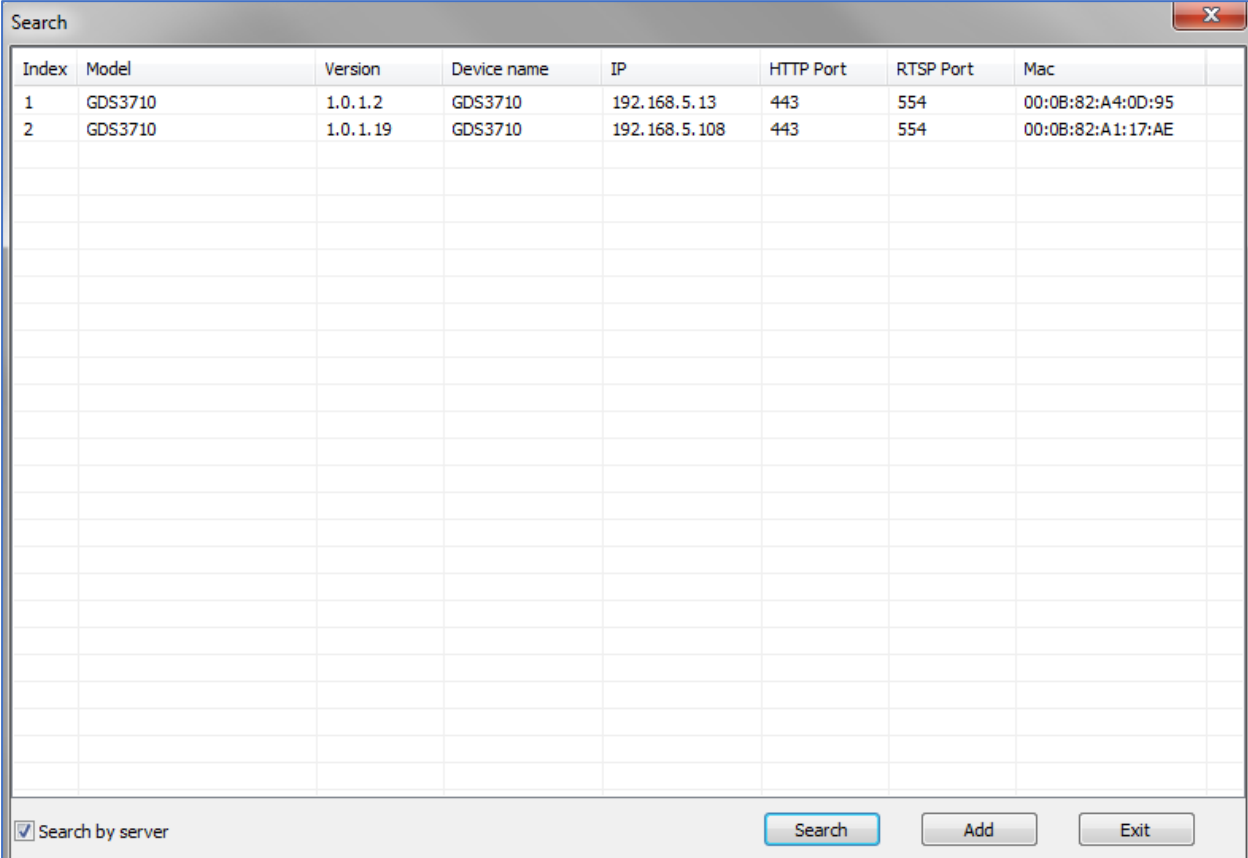

The screenshot shows a window titled 'Search' with a table of detected devices. The table has columns for Index, Model, Version, Device name, IP, HTTP Port, RTSP Port, and Mac. Two devices are listed, both of model GDS3710.

Index	Model	Version	Device name	IP	HTTP Port	RTSP Port	Mac
1	GDS3710	1.0.1.2	GDS3710	192.168.5.13	443	554	00:0B:82:A4:0D:95
2	GDS3710	1.0.1.19	GDS3710	192.168.5.108	443	554	00:0B:82:A1:17:AE

At the bottom of the window, there is a checkbox labeled 'Search by server' which is checked, and three buttons: 'Search', 'Add', and 'Exit'.

Figure 10: GDS3710 Detection

5. Double click the column of the detected GDS3710, the browser will automatically open and show the device’s web configuration page.
6. The browser will ask for plug-in if not installed, please authorize the installation of the plug-in.
7. Enter the administrator user name and password to access the Web Configuration Interface, the default user name and password are both set to **admin**.
8. The plug-in can be download from the GDS3710 webGUI.

Apple Platform

For Apple users, please turn on Bonjour of Safari to find and access the GDS3710.

1. Open Safari, select “Advanced” to open the Advanced Setting.
2. Click “Include Bonjour in the Bookmarks menu” and “Include Bonjour in the Favorites bar” then close the setting page and back to Safari.

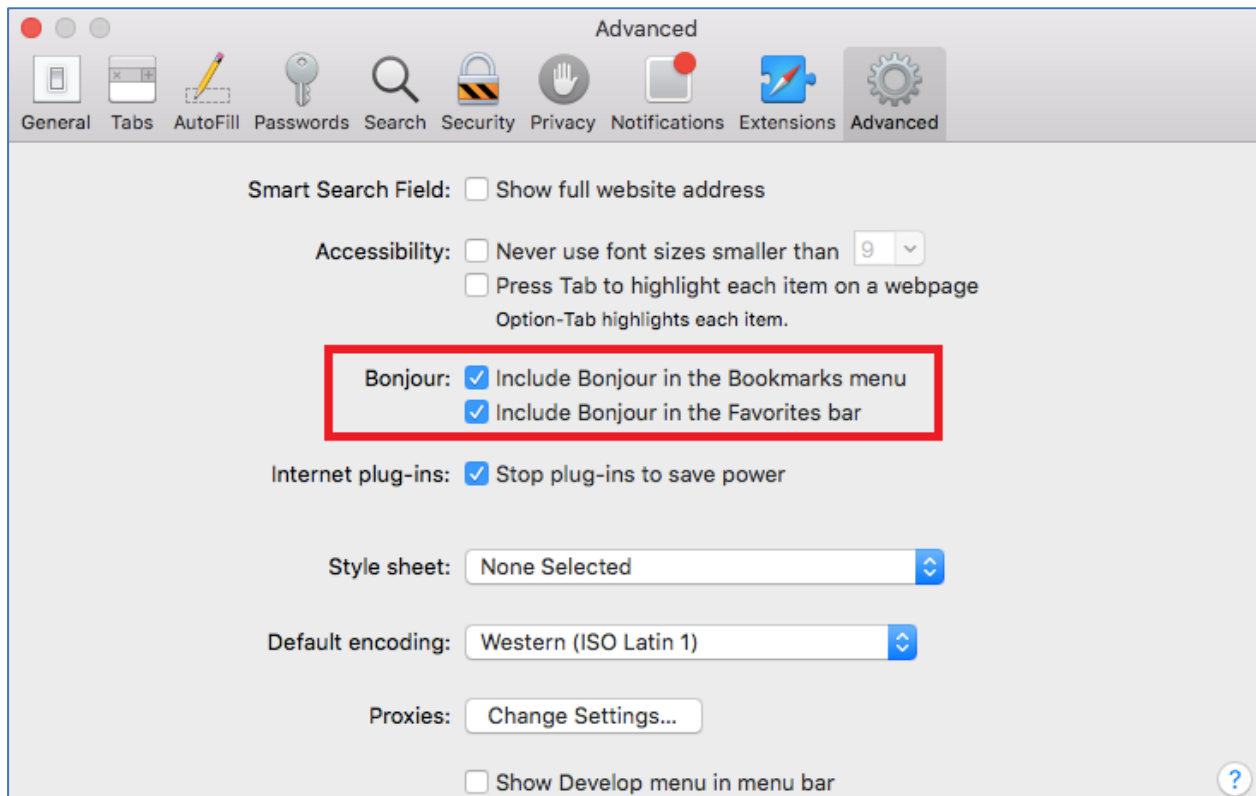

Figure 11: Apple Safari Settings Page

3. Bonjour will now display embedded at Safari. Select “Bonjour” pull-down menu and select “Webpages”, the related device like GDS3710 will be there.



Figure 12: Bonjour Setting Page

4. Click the displayed GDS3710 to access to the configuration page of the GDS3710.



- To see the video, user should change the video codec from default H.264 to **MJPEG**, and type in following to URL:

http://IP_Address_GDS3710:Port/mjpeg/mjpegX.html

(X: 0, 4, 8 represent 1st, 2nd and 3rd stream, Default Port: 80)



Figure 13: MJPEG Stream

Notes:

- The instructions provided above are based on Safari/OS-X, other Apple platform like iOS (iPhone/iPad) can use similar method.

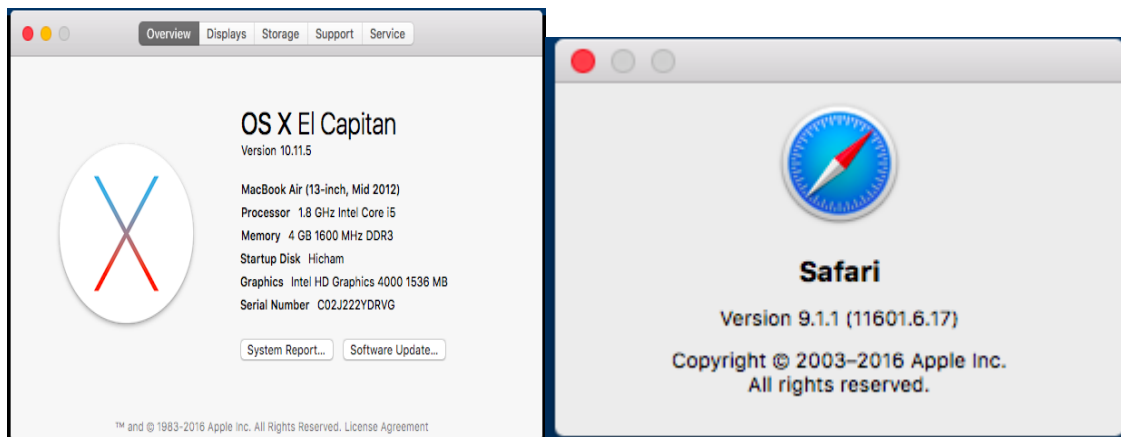

- iPhone/iPad (iOS) users are recommended to use Applications in Apple Store.
- Free or Paid applications from Apple Store like "IP Cam Viewer" is suggested and verified working with Grandstream GDS3710.
- Apple Store applications like "IP Cam Viewer" will support H.264 video codec.

Connect to the GDS3710 using Static IP

If there is no DHCP server in the network, or the GDS3710 does not get IP from DHCP server, user can connect the GDS3710 to a computer directly, using static IP to configure the GDS3710.

1. The default IP, if no DHCP server, or DHCP offer time out (after 3 minutes), is 192.168.1.168
2. Connect the RJ45 cable from GDS3710 to the computer network port directly.
3. Configure the computer using Static IP: 192.168.1.XXX (1<XXX<255, except for 168) and configure the “Subnet mask” to “255.255.255.0”. Leave the “Default Gateway” to “Blank” like below:

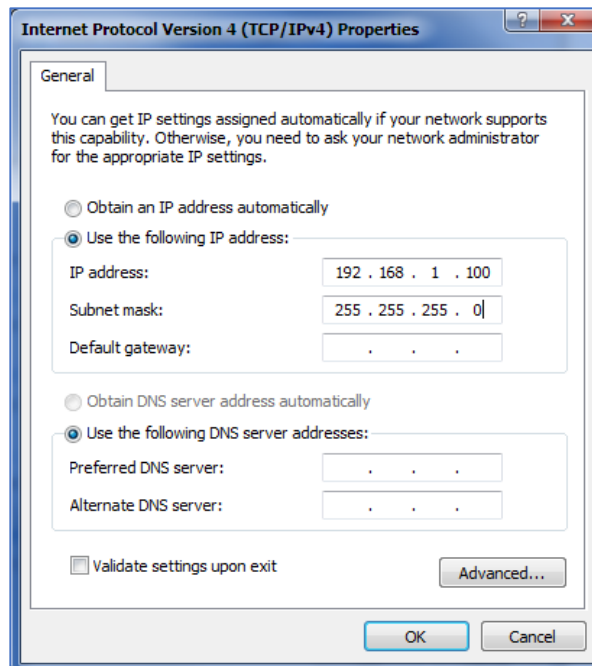

Figure 14: Static IP on Windows

4. Power on the GDS3710, using PoE injector or external DC power.
5. Enter 192.168.1.168 in the address bar of the browser, log in to the device with admin credentials. The default user name and password are both set to **admin**.
6. The browser will ask for plug-in or ActiveX if not installed, otherwise it will get to Home page and show web interface of GDS3710.
7. Access the Web Configuration Interface. IE will indicate that “This website wants to install the following add-on: GSViewerX.cab from Grandstream Networks Inc.”, allow the installation.
8. Firefox, Chrome users need to download and install the following plug-in to see the video from the GDS3710 webGUI.

Note: Please temporarily disable Antivirus or Internet Security Software and close all browsers when download and install the Grandstream Plug-in Software.



GDS3710 APPLICATION SCENARIOS

The GDS3710 Door System can be used in different scenarios.

Peering Mode without SIP Server

For environment like remote warehouse/storage, grocery store, small (take-out) restaurants, just using static IP with PoE switch to form a LAN, using Grandstream's video phone GXV3240 or GXV3275, the GDS3710 will meet your very basic intercom, open door and surveillance requirement.

This is the solution to upgrade the traditional analogue Intercom and CCTV security system. All you need is a Power source, Switch or PoE Switch and Grandstream GXV3240 or GXV3275 video phones.

The equipment list can be found below:

- GDS3710
- GXV3240 or GXV3275
- PoE Switch with related Cat5e/Cat6 wiring

Peering Using SIP Server (UCM6XXX)

For large deployment, multiple GDS3710 might be required, peered connection will not work in such case due to multiple connections. Such scenarios require an IPPBX or a SIP Proxy to accomplish the tasks.

If remote access is required, a router with internet access should be added to below needed equipment list:

- Several GDS3710
- UCM6XXX or another SIP Server
- GXV3240 or GXV3275 Video Phones
- PoE Switch with related Cat5e/Cat6 wiring
- Electronic Lock

If remote access to the GDS3710 is required for viewing live video stream, Internet access is required and more equipment such as:

- Router.
- Internet Access (Optical fiber, 3G, 4G, Cable or DSL).
- iPhone or Android phone with 3rd party applications (IP Cam Viewer for instance).



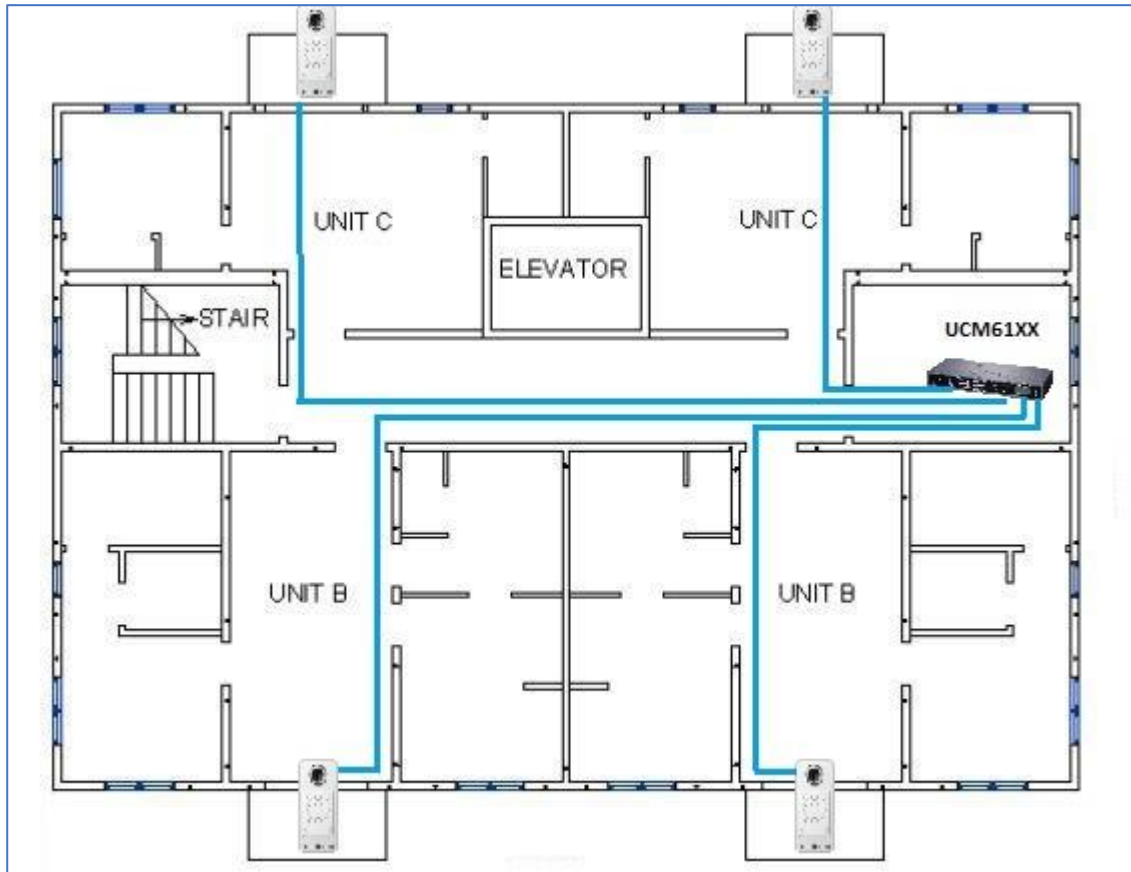

Figure 15: Peering GDS3710 With UCM6XXX

Using a Network Video Recorder (GVR355X)

For implementation with more than two GDS3710s, if local video recording is required to store the record, then an NVR like GXV355X will be added to save all the video stream when people enter the door.

Equipment List:

- Several GDS3710
- GVR355X NVR
- PoE switches with Cat5e/Cat6 wiring
- Router
- Internet Access (Optical fiber, 3G, 4G, Cable or DSL).
- iPhone or Android phone with 3rd party APP

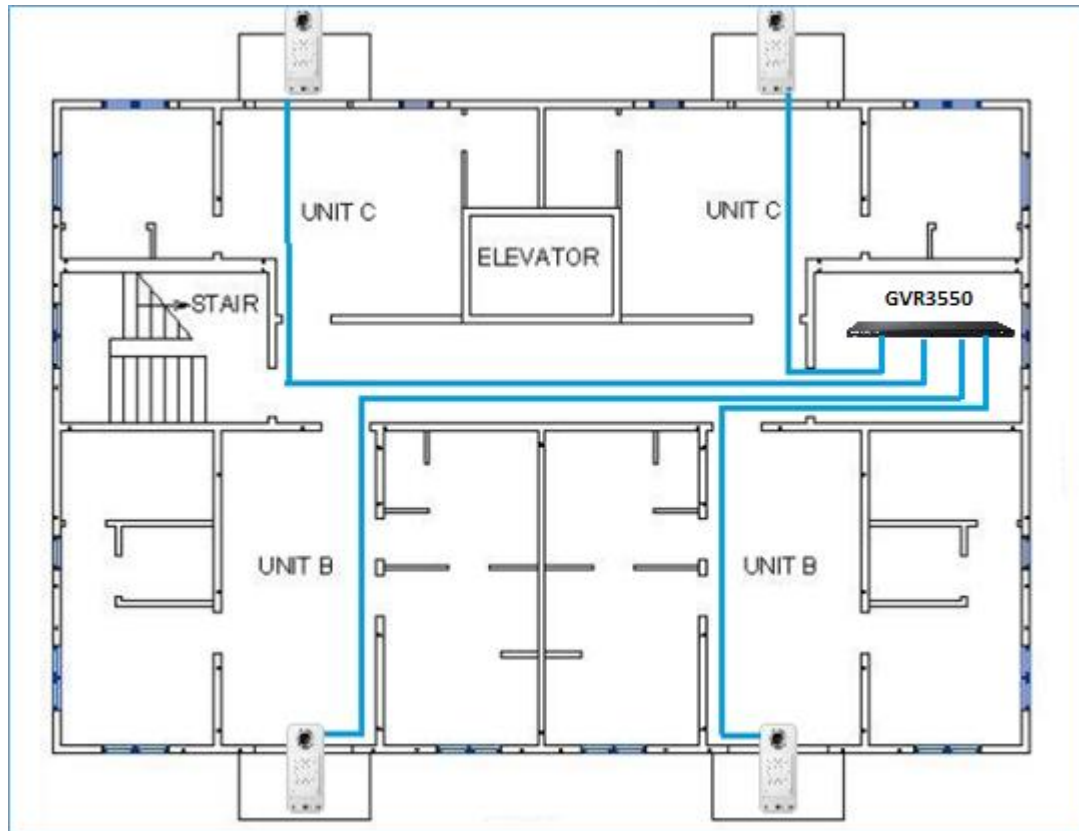

Figure 16: Peering GDS3710 With GVR3550

Peripheral Connections of GDS3710

Below is the illustration of GDS3710 peripheral connections for related applications.

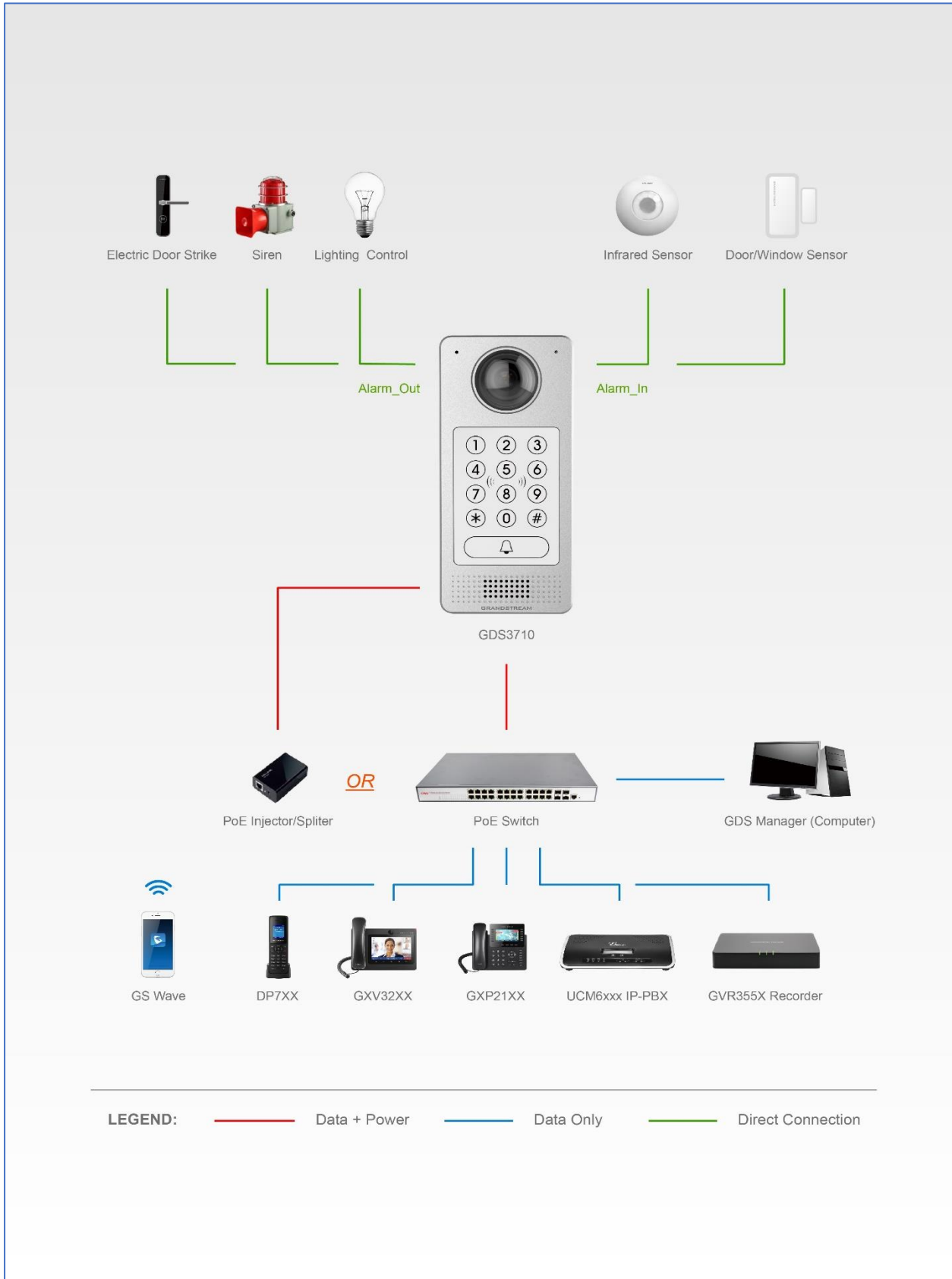

Figure 17: Peripheral Connections for GDS3710



Alarm IN/OUT

Alarm_In could use any 3rd party Sensors (like IR Motion Sensor).

Alarm_Out device could use 3rd party Siren and Strobe Light, or Electric Door Striker, etc.

The figure below shows illustration of the Circuit for Alarm_In and Alarm_Out.

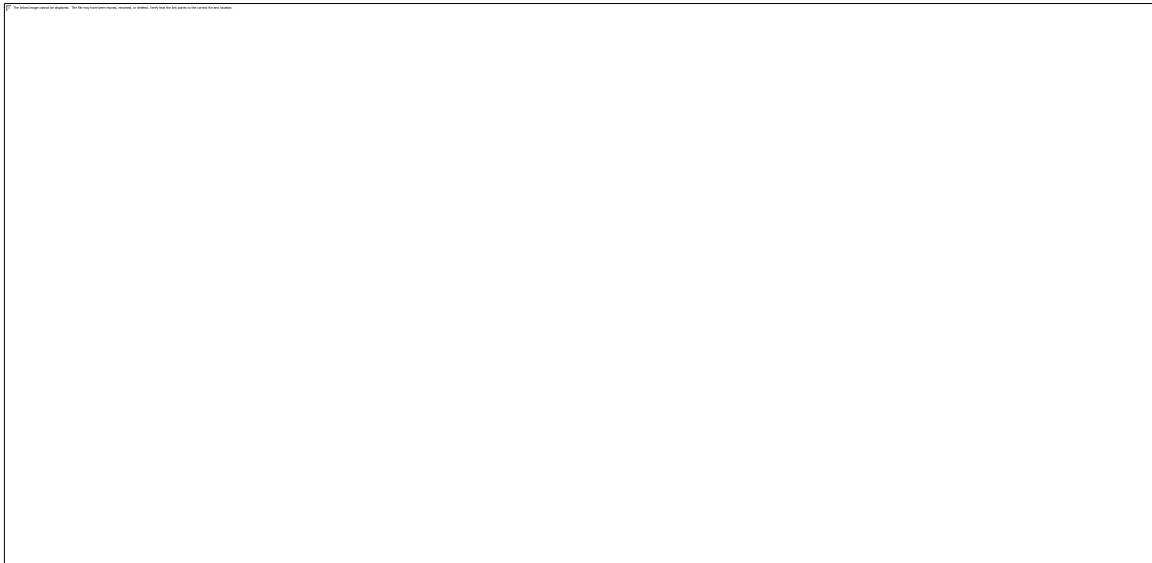

Figure 18: Alarm_In/Out Circuit for GDS3710

Notes:

- The Alarm_In and Alarm_Out circuit for the GDS3710 should meet the following requirement:

Alarm Input	3V<Vin<15V, PINs (1.02KΩ)
Alarm Output	125VAC/0.5A, 30VDC/2A, Normal Open, PINs

- The Alarm_In circuit, if there is any voltage change between 3V and 15V, as specified in the table above, the GDS3710 Alarm_In port will detect it and trigger the action and event.
- Higher voltage and wrong polarity connection are prohibited because this will damage the devices.

Protection Diode

When connecting the GDS3710 to a door strike it is recommended to set an EMF protection diode in reverse polarity for a secure use, below examples of deployment for the protection diode.

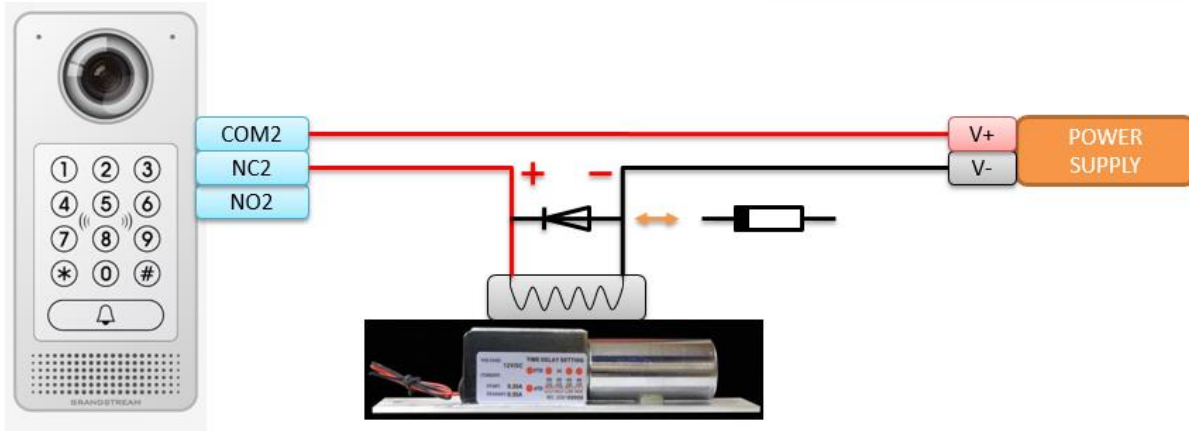

Electric lock

Figure 19: Example 1

The reverse EMF protection diode must always be installed in reverse polarity across the door strike.

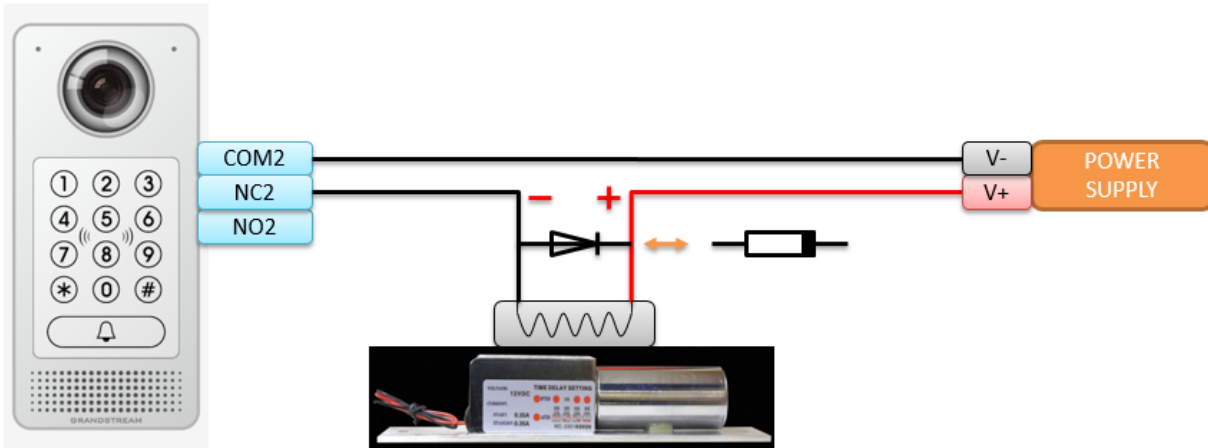

Electric lock

Figure 20: Example 2

Connection Examples

Below examples, show how to use wiring on the back cover of the GDS3710 to connect with external devices. The “NO” (Normal Open) model strike is used as example, “NC” (Normal Closed) should be similar and users need to decide which model (NO or NC) to be used on the door.

Wiring Sample using 3rd Party Power Supply

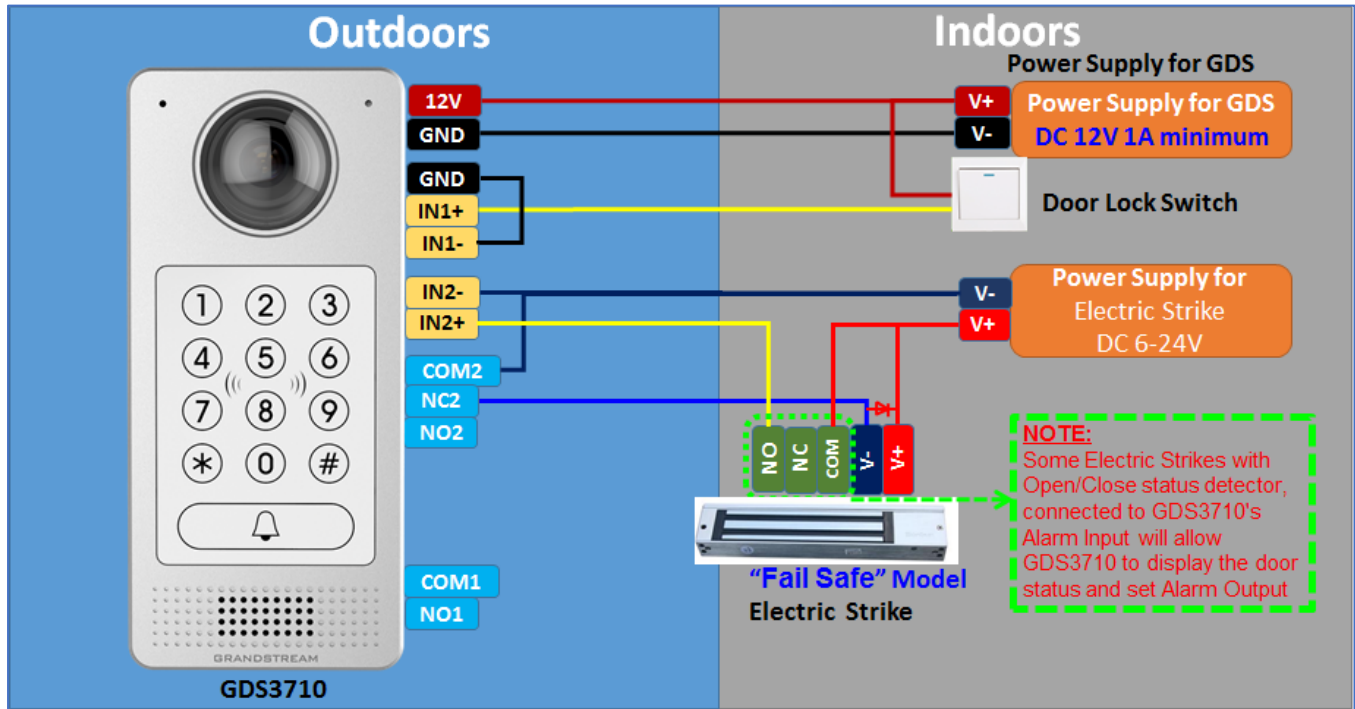

Figure 21: 3rd Party Power Supply Wiring Sample

Wiring Sample using Power Supply for both GDS3710 and Electric Strike

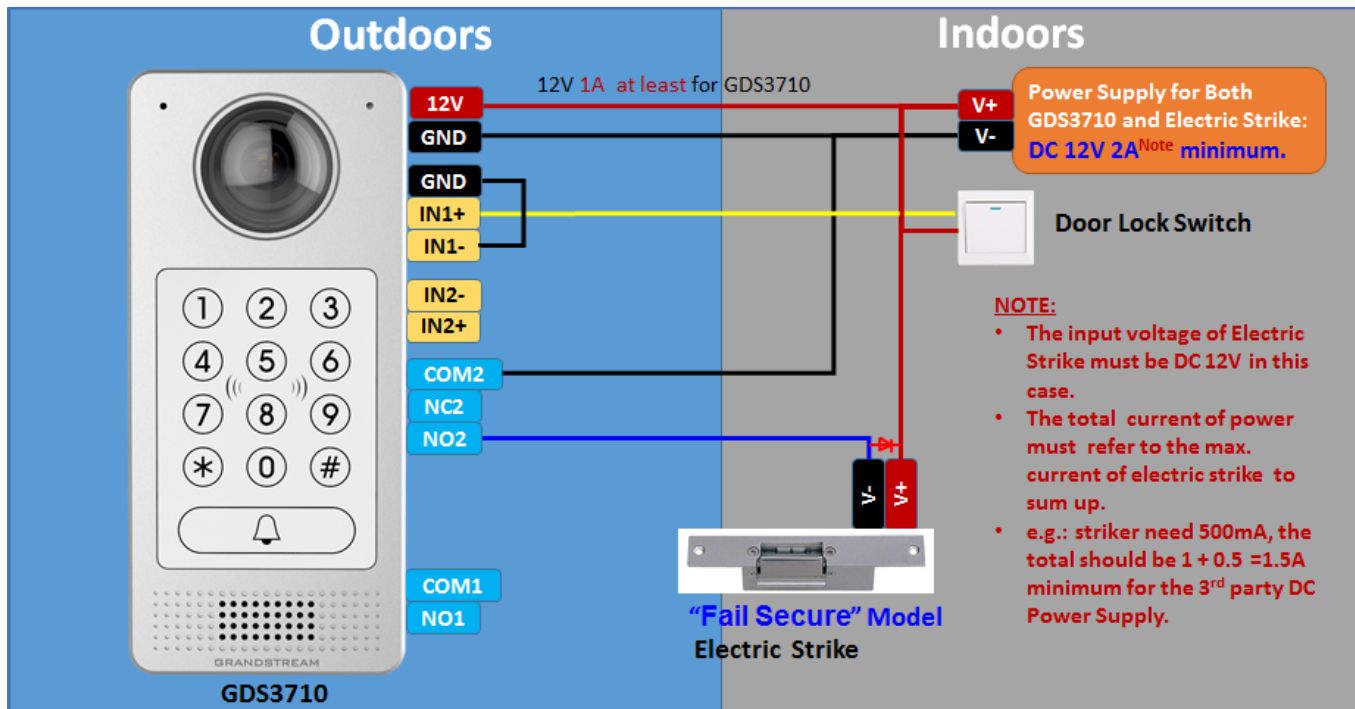

Figure 22: Power Supply Used for Both GDS3710 and Electric Strike



Wiring Sample using PoE to power GDS3710 and 3rd Party Power Supply for Electric Strike

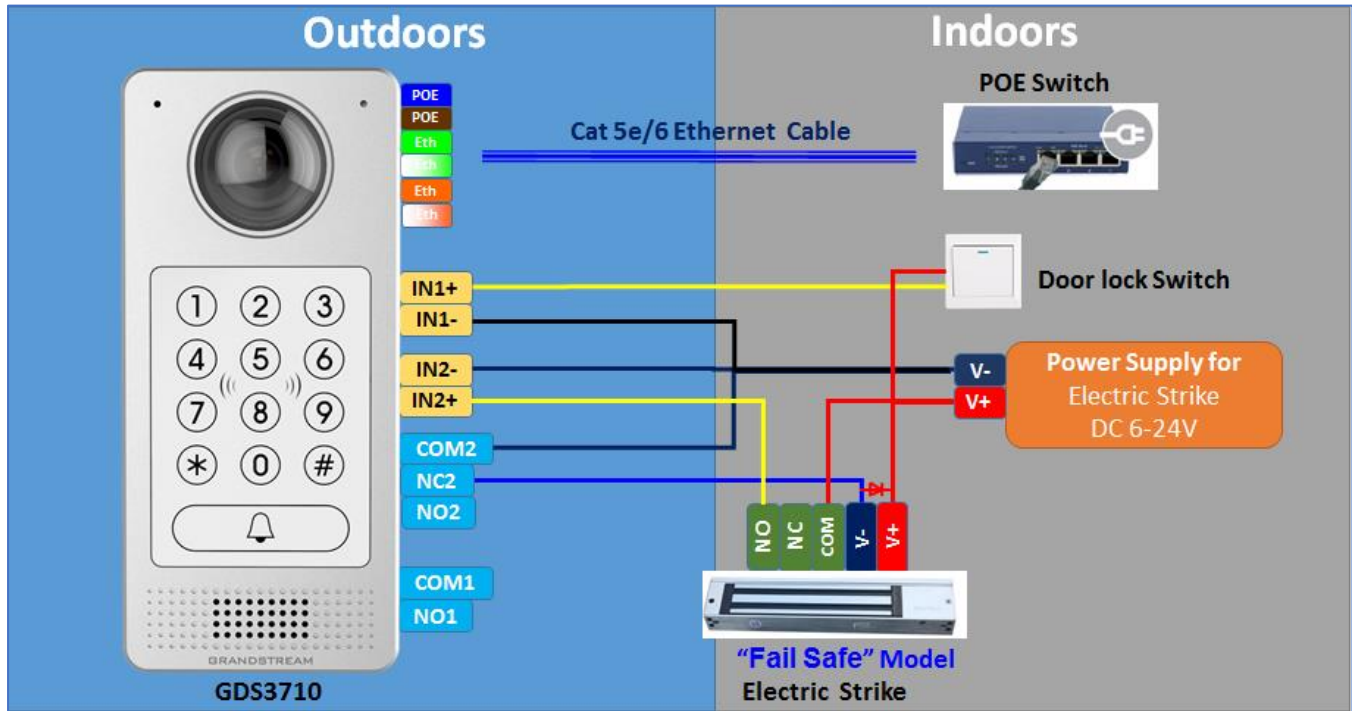

Figure 23: Wiring Sample Using PoE to power GDS3710 and 3rd Party Power supply for Electric Strike

Warning: The following example should be avoided when powering the electric strike

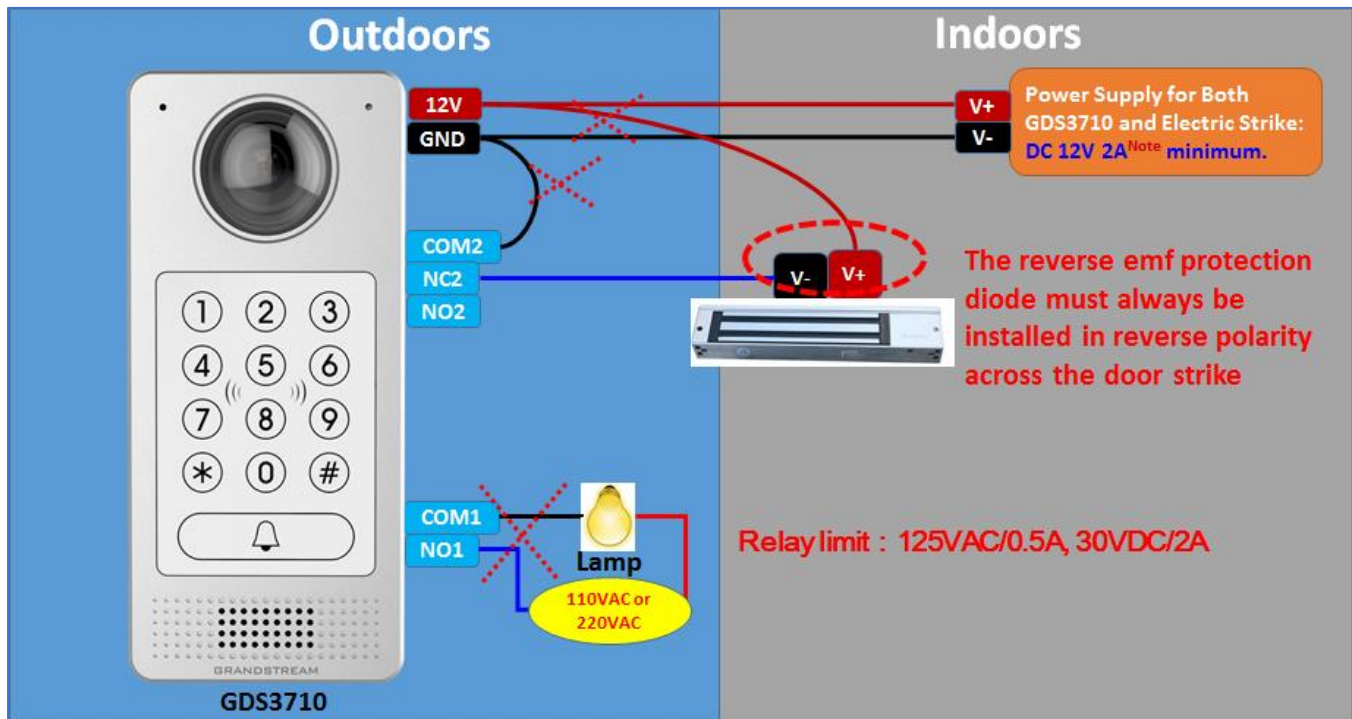

Figure 24: Example to Avoid When Powering the Electric Strike

Good Wiring Sample for Electric Strike and High Power Device

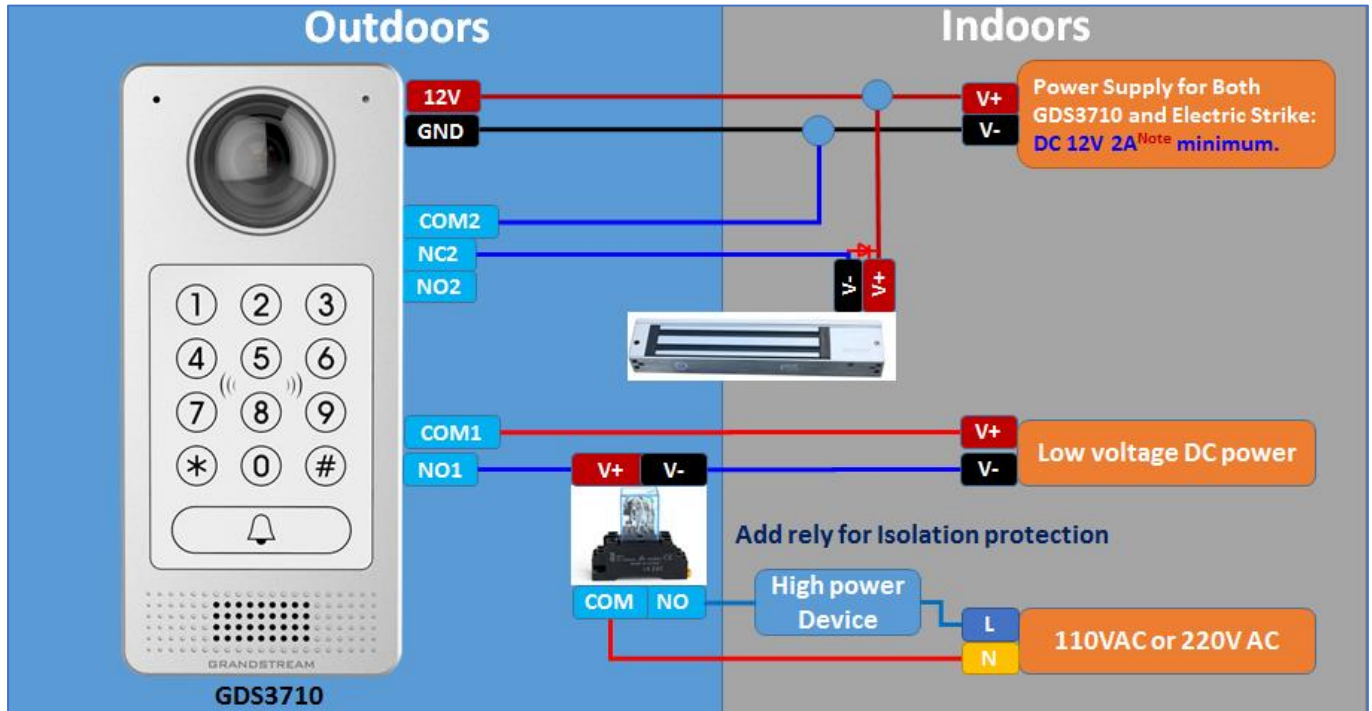

Figure 25: Electric Strike and High Power Device Example

Wiegand Module Wiring Examples

GDS3710 package is shipped with one Wiegand cable for Input/Output Wiegand connections, the following examples shows how to connect the Wiegand Input/Output devices to the GDS3710.

Input example with 3rd party power supply for Wiegand device

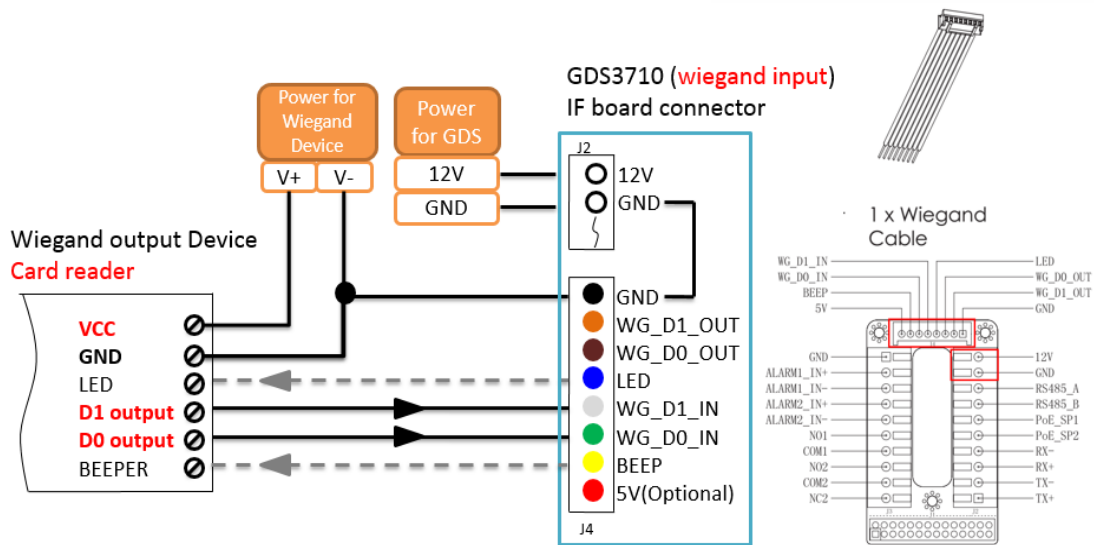

Figure 26: Wiegand Input Example with 3rd Party Power Supply

Make sure to connect the GND of the Wiegand device and the GDS3710 Wiegand port.

For Wiegand input mode, LED and BEEP pins require that the Wiegand device support those interfaces. These two pins will not affect the Wiegand bus when not connected.

Input example with power supply for both GDS3710 and Wiegand Device

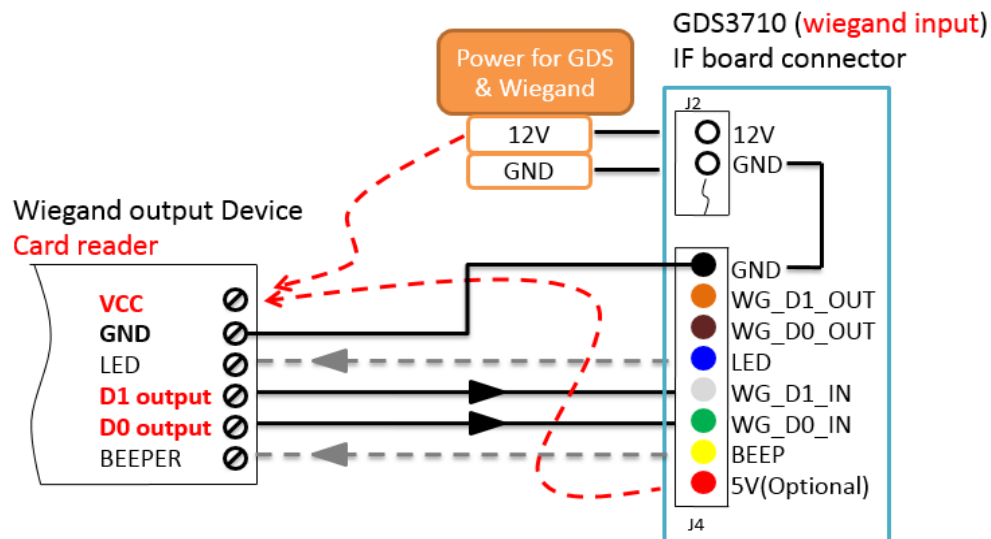

Figure 27: Wiegand Input Example with Power Supply for GDS3710 and Wiegand Device

If power source is **12VDC**, Wiegand device can share same power source of GDS3710. However, users need to check the max power consumption and the max capability of the power source.

If Wiegand device is using **5VDC**, GDS3710 Wiegand port can provide 5VDC with max 500mA to power up Wiegand device.

Output example with 3rd party power supply for Wiegand device

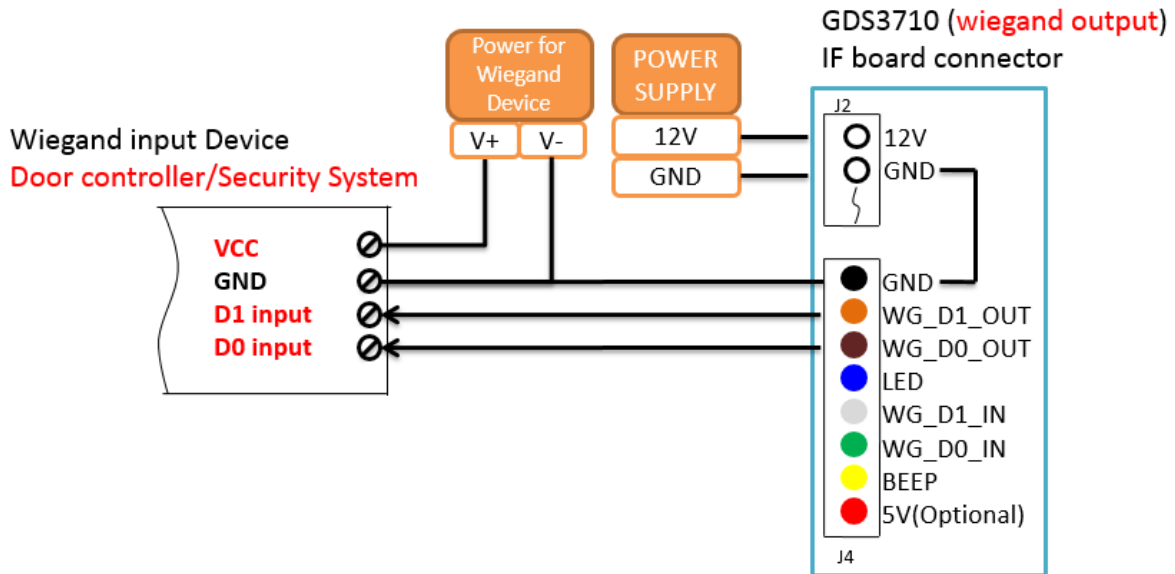

Figure 28: Wiegand Output Wiring Example

When the Wiegand output of the GDS3710 is connected, it acts as the signal receiver of the 3rd party Wiegand device, connecting to door controller. The major wiring is GND, D0, and D1. Because usually the door controller will consume big current and power, the power supply should be separated.

Wiegand RFID Card Reader Example

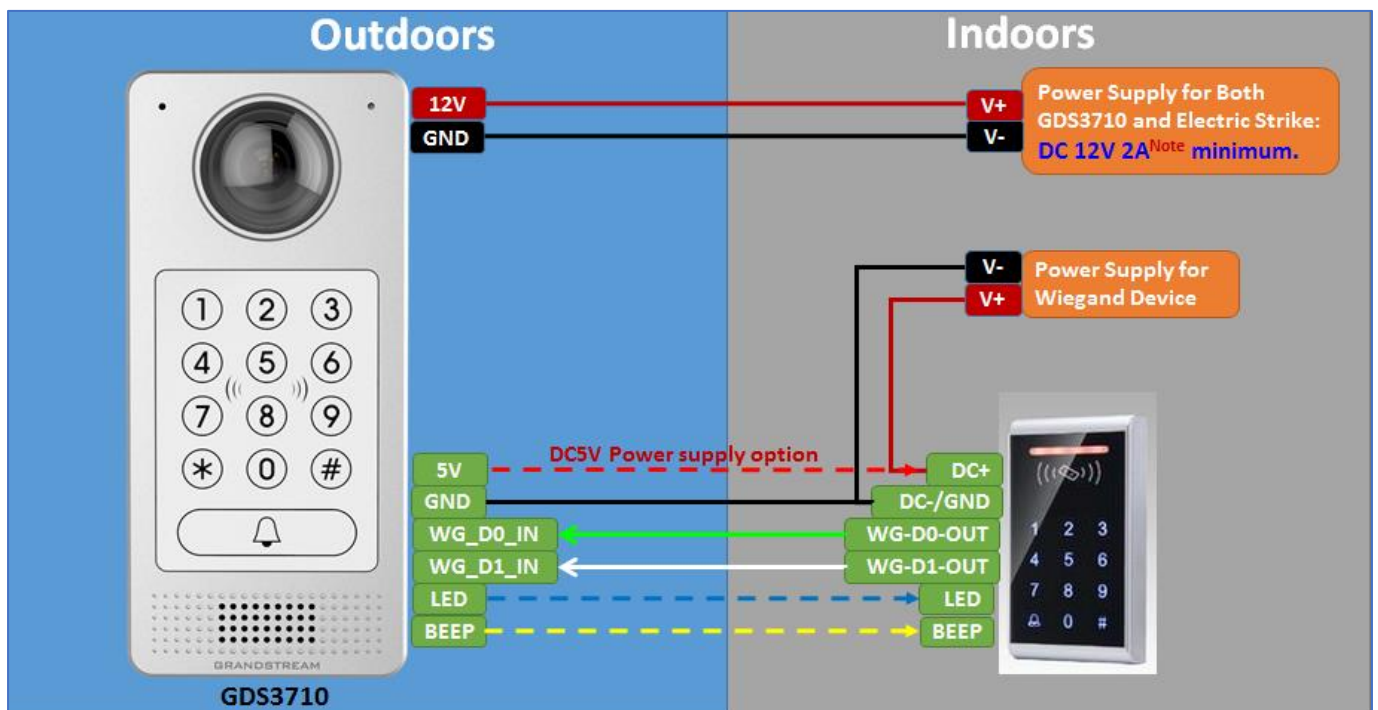

Figure 29: Wiegand RFID Card Reader Example

GDS3710 HOME WEB PAGE

Once logged in successfully to the GDS3710, User will see the following page.

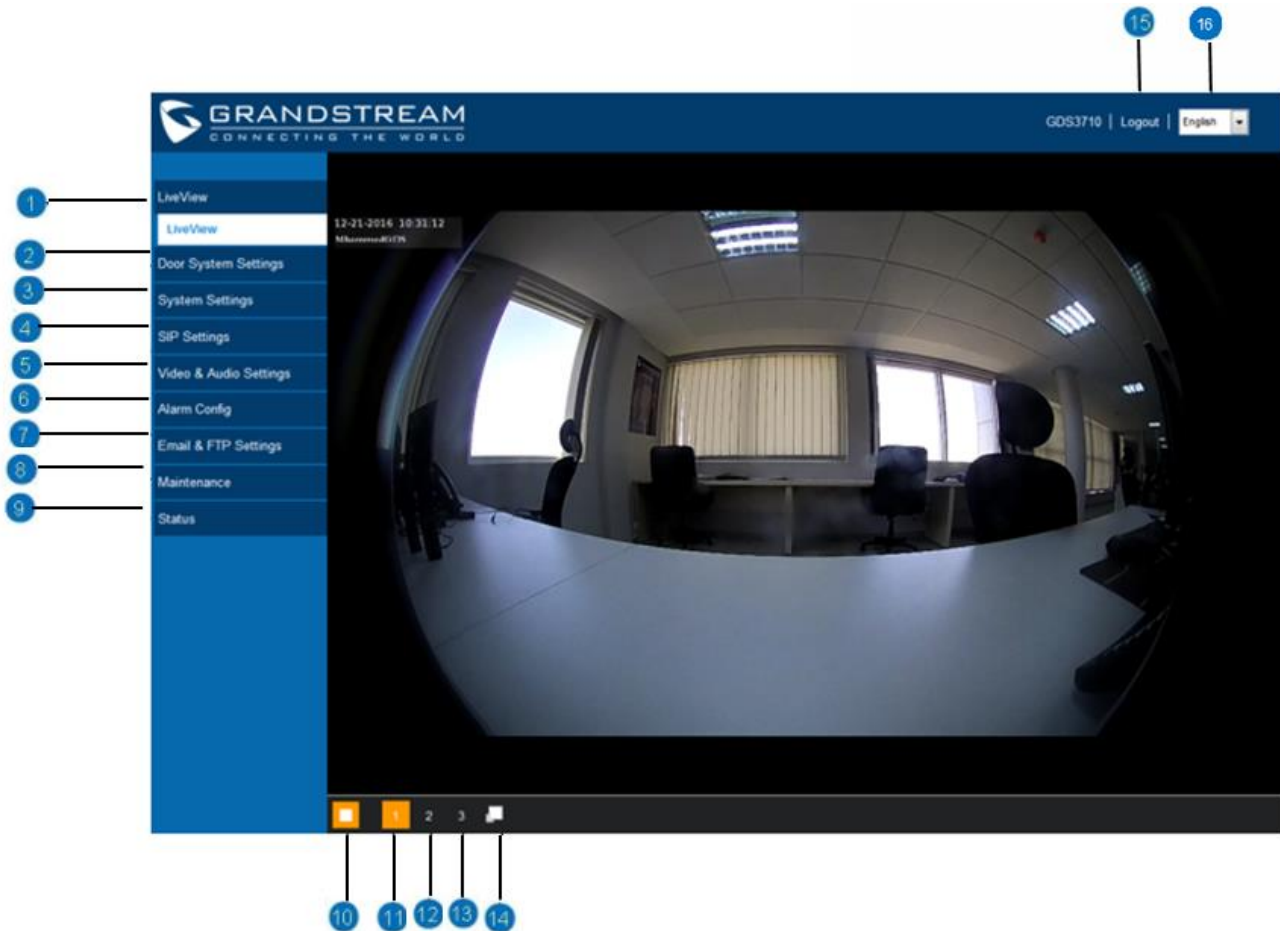

Figure 30: Home Page

Table 5: Home Page Description

Number	Fields	Description
1	LiveView	Displays the Video stream.
2	Door System Settings	Click to enter "System Settings" page.
3	System Settings	Click to enter "Door System Settings" page.
4	SIP Settings	Click to enter the "SIP settings" page.
5	Video & Audio Settings	Click to enter the "Video & Audio settings" page.
6	Alarm config	Click to enter "Alarm config" page.
7	Email & FTP Settings	Click to enter the "Network Settings" page.
8	Maintenance	Click to enter "Maintenance" page.
9	Status	Click to enter "Status" page.

10	Play/Stop	Start/Stop the video stream in the web page.
11	Stream 1	Play the primary stream.
12	Stream 2	Play the secondary stream.
13	Stream 3	Play the 3 rd stream.
14	Window size	Resize the window.
15	Logout	Logout from web page.
16	Language	Click to switch webpage language.

GDS3710 Configuration & Language Page

- Once the IP address of the GDS3710 is entered on the user browser the login web page will pop up allowing user to configure the GDS3710 parameters.
- When clicking on the “Language” drop down, supported languages will be displayed as shown in Figure below. Click to select the related webpage display language.



Figure 31: Switch Language Page

Note: Current firmware supports only English (default) and simplified Chinese.

GDS3710 SETTINGS

Live View Page

This page allows users to view the live video of the GDS3710 after installing related pug-in and allowing it to run on from the used browser.



Figure 32: Live View Page

Three streams are available:

- **Primary video stream:** 1920*1080 resolution, recommended for continuous full HD recording (If used with GXV355X NVR).
- **Secondary video stream:** 640*480 resolution, recommended for SIP/VoIP video calls (if used with GXV3240/GXV3275).
- **Third video stream:** 320*240 resolution, recommended for smartphone or Tablet Apps (IP Cam Viewer for instance).

The icon next to the third stream  allows users to switch between real size video and adjusted size video (appropriate for the window frames).

Door System Settings

This page allows users to configure parameters regarding system operations, like input PIN for the door and manage users' settings.

Basic Settings

LiveView	Door System Settings	
Door System Settings	Unlocking Latency(s) <input type="text" value="0"/>	
Basic Settings	Unlock Hold Time(s) <input type="text" value="5"/>	
Card Management	Swipe Card Intervals(ms) <input type="text" value="300"/>	
System Settings	Capture Image on Unlock <input checked="" type="checkbox"/>	
SIP Settings	Call Mode <input type="text" value="SIP Number"/>	
Video & Audio Settings	Doorbell Mode <input type="text" value="Call Doorbell Number"/>	
Alarm Config	Number Called When Door Bell Pressed <input type="text"/>	
Email & FTP Settings	Remote PIN to Open the Door <input type="text"/>	
Maintenance	Local PIN Type <input type="text" value="Unified PIN"/>	
Status	Local PIN to Open the Door <input type="text" value="*****"/>	
	Enable Guest PIN <input checked="" type="checkbox"/>	
	Guest PIN <input type="text" value="*****"/>	
	Guest PIN Duration Start Time <input type="text" value="2017/02/21 00:00:00"/>	
	Guest PIN Duration End Time <input type="text" value="2017/02/28 00:00:00"/>	
	Card Issuing State Setting	
	Enable Card Issuing Mode <input type="checkbox"/>	
	Light Settings	
	Enable Key Blue Light <input checked="" type="checkbox"/>	
	Enable Background Light <input checked="" type="checkbox"/>	
	Key Tone Setting	
	Key Tone Type <input type="text" value="DTMF"/>	
	Wiegand Settings	
	Wiegand Input Enable <input type="checkbox"/>	
	Wiegand Output Enable <input type="checkbox"/>	
	<input type="button" value="Save"/>	

Figure 33: Door System Settings Page



Table 6: Door System Settings

Unlocking Latency(s)	Time delay in second for the electronic lock to be triggered (default value is 0 seconds).
Unlock Hold Time(s)	Lock holding time, in seconds (default value is 5 seconds).
Swipe Card Intervals(ms)	Defines the interval in ms to swipe consecutive RFID cards. The range should be between 0ms and 2000ms.
Capture Image on Unlock	Click to enable image caption or snapshot when electronic lock operates.
Call Mode	Choose whether to make call to the SIP number or Virtual Number when dialing from the GDS3710 keypad.
Doorbell Mode	Choose the action to be taken when the doorbell is pressed, three options are available: <ul style="list-style-type: none"> • Call Doorbell Number: when Doorbell is pressed, a call will be made to the “Number Called When Door Bell Pressed” • Control Doorbell Output (Digital Output 1): when Door Bell is pressed electronic lock for Output 1 is opened. • Both of Above: When selected, both Call Doorbell Number and Control Doorbell Output options are enabled.
Number Called When Door Bell Pressed	SIP extension number (SIP Server mode), or IP address with port number (peering mode), to be called when the Door Bell is pressed.
Remote PIN to Open the Door	PIN code stored in the GDS3710, remote SIP phone needs to input and match this PIN (the PIN is sent via DTMF while in call) so that the GDS3710 can open the door.
Local PIN Type	Two Options are available, Unified PIN or Private Card PIN. <ul style="list-style-type: none"> • Unified PIN: This Feature means all members share a same PIN to unlock the door. Users need to enter the following sequence from the GDS3710 keypad to open the door [*Local PIN to Open the Door#]. • Private Card PIN: Means every member has a private PIN, the GDS will record who unlocked the door every time. Users need to enter the following sequence from the GDS3710 to open the door [*Virtual Number*Private Door Password#].
Local PIN to Open the Door	PIN stored in GDS3710, input locally this PIN on the GDS3710 keypad will unlock the door. (This Feature needs Unified PIN activated)
Enable Guest PIN	Click to enable password entry for guests.



Guest PIN	Enter the password that will be used by guests.
Guest PIN Duration Start Time	Select the start time when the Guest PIN start to take effect.
Guest PIN Duration End Time	Select the end time when the Guest PIN will stop working.
Enable Card Issuing Mode	Check to enable RFID card issuing/program into the GDS3710. When selected sweeping an RFID card into the GDS3710 will add card information into [Card Management].
Enable Key Blue Light	When checked, the blue light will be activated when pressing the GDS3710 Keys.
Enable Background Light	When checked, the background light will turn on once clicking the GDS3710 Keys.
Key Tone Type	Key tone for the GDS3710. <ul style="list-style-type: none"> • Default: Beeps will be played when pressing the GDS3710 keys. • DTMF: Tones will be played when pressing the GDS3710 keys. • Mute: No sound will be played when pressing keys.
Wiegand Input Enable	Enable Wiegand Input.
Wiegand Output Enable	Enable Wiegand Output.

Notes: Remote SIP phone needs password (digits 0-9 only, ended with # key) matching the configuration on the web page to open the door (via DTMF).

GDS3710 support RFID for multiple users to open door, therefore every user has its own PIN. For environment with 100 users and more, it's difficult for the GDS3710 to manage all these users and a separate PC or Server should be involved for such kind of management and monitoring.

In environments with more than 100 users the GDS3710 supports one unified Local PIN for opening the door for all the users.

Card Management

This page allow user to add information about RFID cards, two options are possible either add RFID cards manually or automatically.



Card Management									
Add User		Reload Data		Delete Data		Import Data		Export Data	
No.	Username*	Virtual Number*	Cellphone	Enable	Detail	Edit	■		
1	Mario	414	0655443344				<input type="checkbox"/>		
2	Taylor	413	0655443311				<input type="checkbox"/>		
3	Bjorn	412	0655443322				<input type="checkbox"/>		
4	John	415	0655443366				<input type="checkbox"/>		

Figure 34: Card Management

Add Users Manually

To add users, click on , the following page will pop up.

Modify Card Info ✕

Username*

Private Door Password

Gender Male

ID Number

Card Number*

Valid Date 20991231

Virtual Number*

Sip Number*

Cellphone

Enable

Note: You can't open door if password is no setted.

Save
Cancel



Figure 35: Card Info

Table 7: Card Info

Username	Set the username to identify the user.
Private Door Password	Set a specific password to unlock the door.
Gender	Select a gender, either Male or Female.
ID Number	Enter an ID number (This number is set by the admin to identify each user uniquely).
Card Number	Enter the RFID Card number (this is the number written on the RFID card. When card issuing mode is enabled, this field will be added automatically).
Valid Date	Set the date of validity of the RFID card.
Virtual Number	When dialing directly from the keypad, the GDS accept only Virtual number to identify a user, once the Virtual number is typed followed by # key, the Sip Number will be dialed.
SIP Number	The SIP Number is mapped with virtual number, once the virtual number is dialed the GDS3710 will send an INVITE to the SIP Number.
Cellphone	Cellphone of the user.
Enable	Enable/Disable the RFID card.



Add Users Automatically

If [Enable Card Issuing Mode] is checked, the GDS3710 keypad will start blinking and once an RFID is swiped, data stored on the card will be added into the GDS3710 card management page, user can still edit the entry added automatically by modifying some fields.

- Click on  to show details of the entry.
- Click on  to edit the entry.
- Click on  to delete the entry.

Click  to refresh the data entered to the GDS3710.

Users can also delete data by clicking on  to delete the selected entry.

Click on  or  to import or export users' information stored in the GDS3710.



Users can use Go to navigate through User Management pages.

System Settings

This page allows users to configure date and time, network settings as well as access method to the GDS3710 and password for accessing the webGUI.

Date & Time Settings

This page allows users to adjust system date and time of the GDS3710.

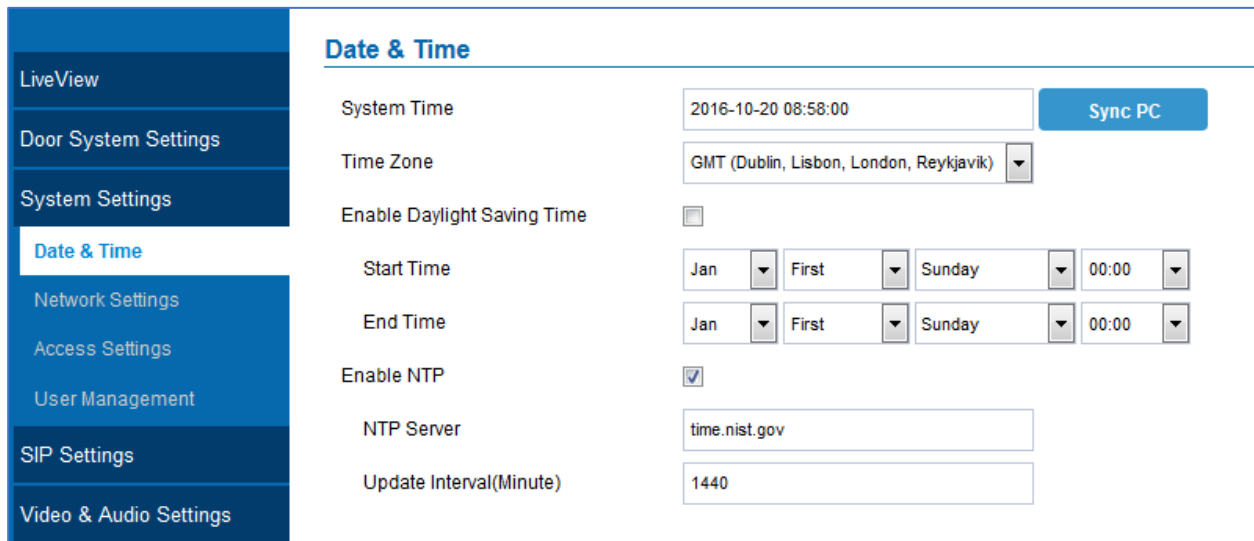

Date & Time	
System Time	2016-10-20 08:58:00 <input type="button" value="Sync PC"/>
Time Zone	GMT (Dublin, Lisbon, London, Reykjavik) ▼
Enable Daylight Saving Time	<input type="checkbox"/>
Start Time	Jan ▼ First ▼ Sunday ▼ 00:00 ▼
End Time	Jan ▼ First ▼ Sunday ▼ 00:00 ▼
Enable NTP	<input checked="" type="checkbox"/>
NTP Server	time.nist.gov
Update Interval(Minute)	1440

Figure 36: Date & Time Page

Table 8: Date & Time

System Time	Display the current system time.
Sync PC	Click to synchronize current time with the computer.
Time Zone	Select from drop down menu the preferred time zone.
Enable Daylight Saving Time	Check to enable Daylight Saving Time.
Start time	Select the Start time of DST.
End Time	Select DST end time.
Enable NTP	Check to enable NTP to synchronize device time.
NTP Server	Input the domain name of NTP server.
Update Interval	Interval (in minutes) to retrieve updates from the NTP server.

Basic Settings

This page allows users to set either a static or DHCP IP address to access the GDS3710.

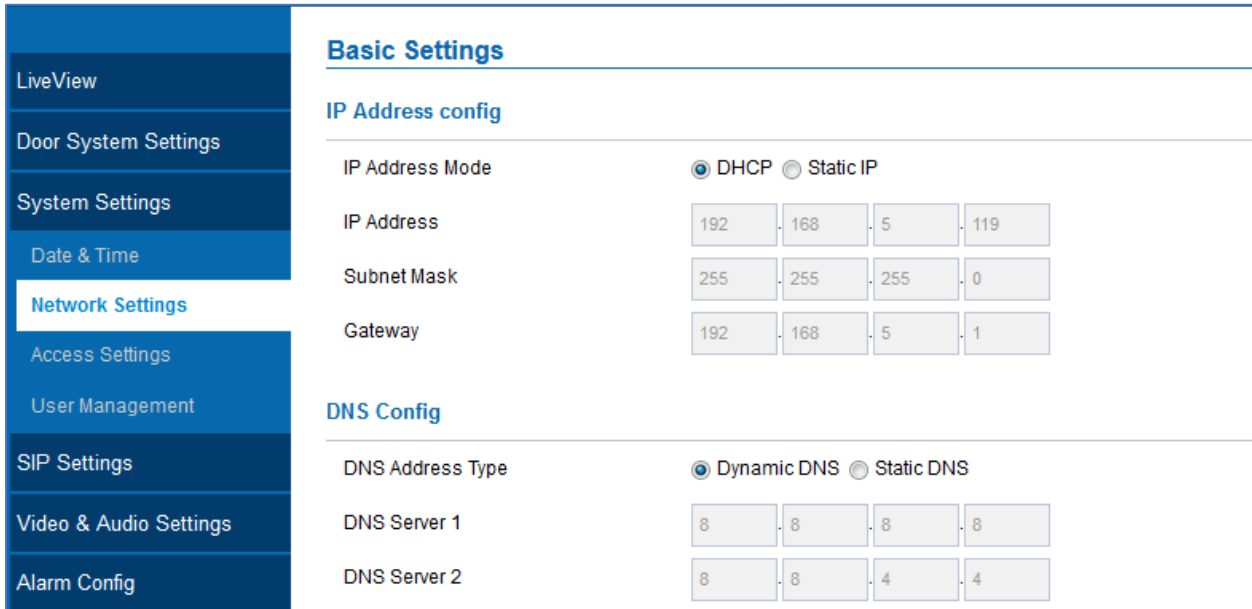

Figure 37: Basic Settings Page

Table 9: Basic Settings

IP Address Mode	Choose DHCP or Static IP. Default DHCP. (Static recommended)
IP Address	Enter the Static IP of the GDS3710.
Subnet Mask	Enter the Associated Subnet Mask.
Gateway	Enter the Gateway IP address.
DNS Address Type	Choose DNS type: Dynamic DNS or Static DNS.
DNS Server 1	Fill in DNS Server 1 IP address.
DNS Server 2	Fill in DNS Server 2 IP address.

Notes:

- If the GDS3710 is behind SOHO (Small Office Home Office) router with port forwarding configured for remote access, static IP should be used to avoid IP address changes after router reboot.
- TCP port above 5000 is suggested to Port forward HTTP for remote access, due to some ISP would block port 80 for inbound traffic. For example, change the default HTTP port from 80 to 8088, to make sure the TCP port will not be blocked.
- In addition to HTTP port, RTSP port is also required to configure via port forwarding, so that the remote party can view the video stream.
- If the default TCP port 80 is changed to port "A", then RTSP port should be "2000+A" (changed from default TCP 554). Both TCP port "A" and "2000+A" should be configured for port forwarding



in the router. For example, if the HTTP port is changed to 8088, the RTSP port should be 10088, both TCP ports 8088 and 10088 should be configured for port forwarding to have remote GDS3710 access: 8088 for web portal, and 10088 for video streaming.

Access Settings

This page configures the GDS3710 access control parameters.

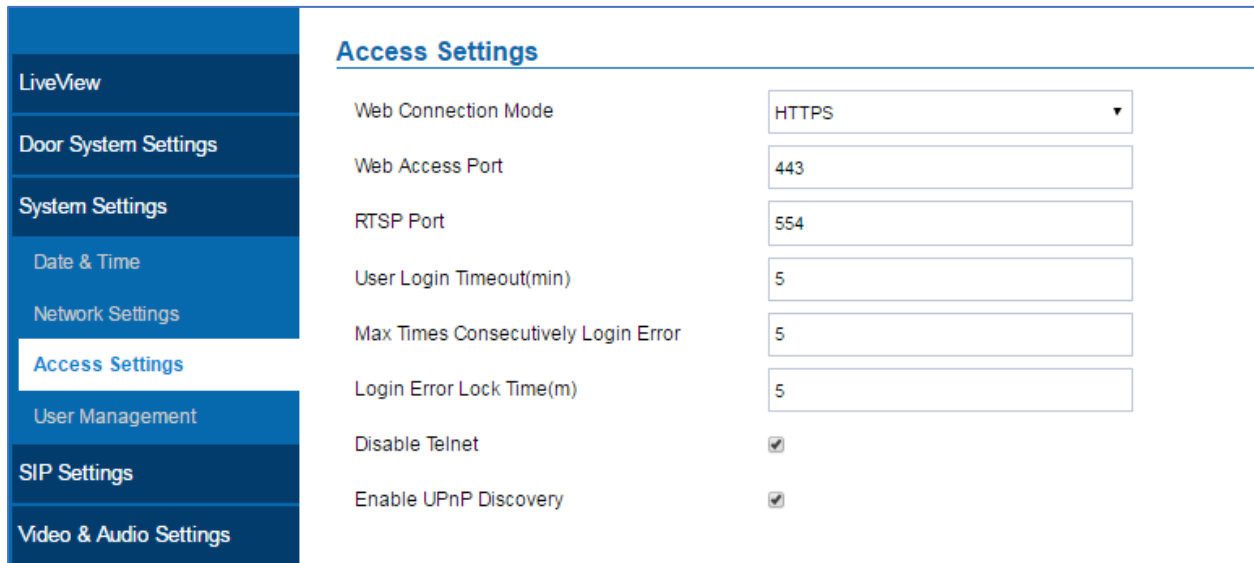

Figure 38: Access Settings Page

Table 10: Access Settings

Web Connection Mode	Select the access mode to the webGUI either HTTP or HTTPS.
Web Access Port	TCP port for Web Access, default 443.
RTSP Port	RTSP port for media stream, default TCP port 554.
User Login Timeout(min)	If no action is made within this time the GDS3710 will logout from the Web GUI, range is between 3 and 60.
Max Times Consecutively Login Error	Specifies the allowed login times error limit, if the unsuccessful login attempts exceed this value, the GDS3710 webGUI will be locked for the time specified in Login Error Lock Time.
Login Error Lock Time(m)	Specifies how long the GDS3710 is locked before a new login attempt is allowed.
Disable Telnet	Select to Enable/Disable Telnet access. Default setting is disabled for security reason.
Enable UPnP Discovery	UPnP (or mDNS) function for local discovery, default Enabled.

User Management

This page allows users to configure the password for administrator. Since this is a door system which must be a secure product, the use is only limited to administrator.

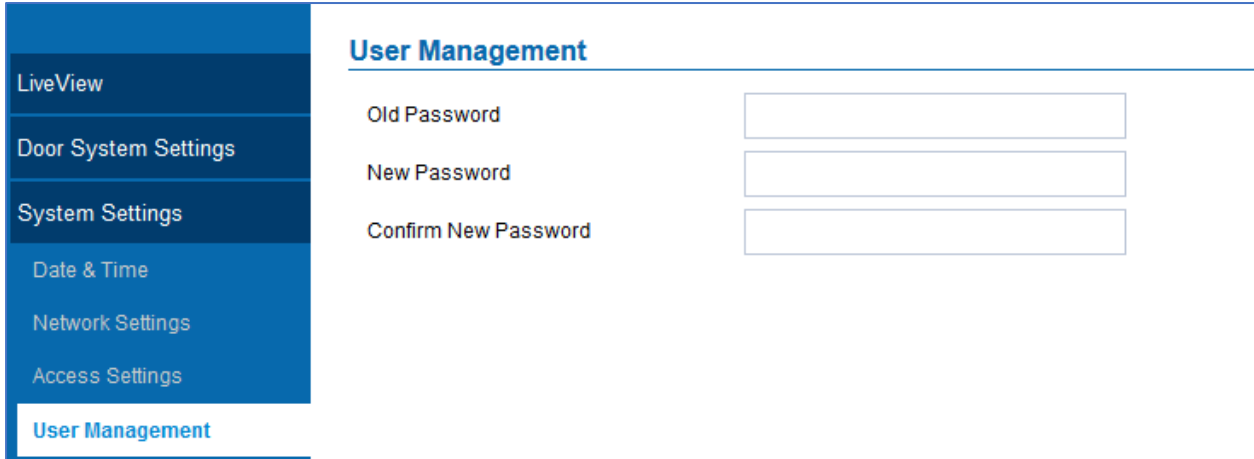

Figure 39: User Management Page

Table 11: User Management

Old Password	Old password must be entered to change new password.
New Password	Fill in the revised new password in this field.
Confirm User Password	Re-enter the new password for verification, must match.

SIP Settings

SIP Basic Settings

Basic Settings allows users to create their SIP account.

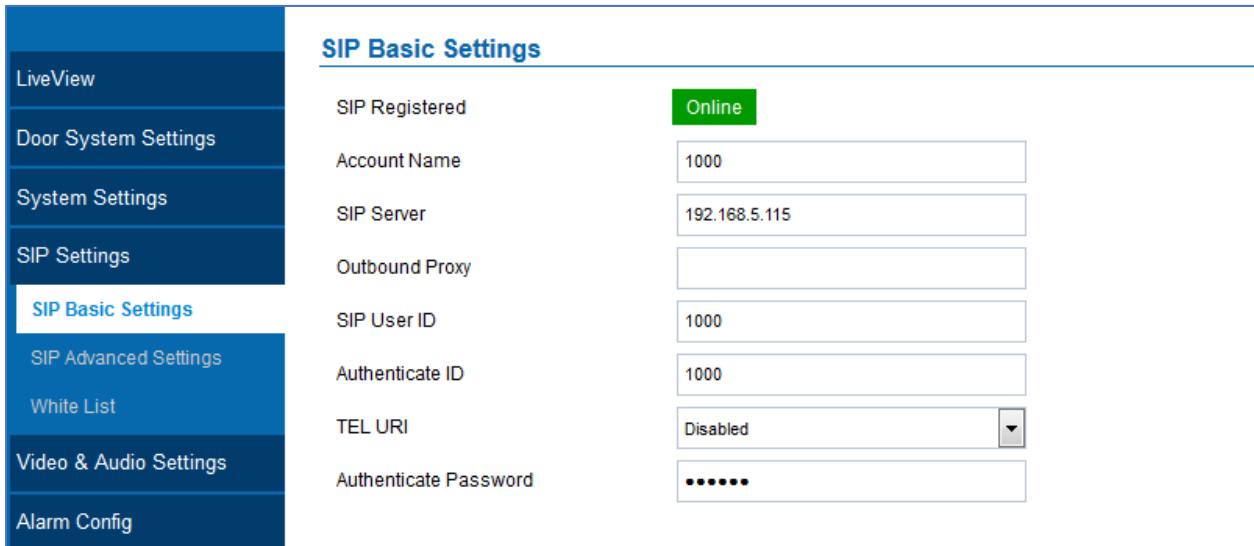

Figure 40: SIP Basic Settings Page



Table 12: SIP Basic Settings

SIP Registered	SIP registration status. Display “Online” or “Offline”.
Account Name	Set the SIP account name used for identification.
SIP Server	Set the FQDN or IP of the SIP server from VoIP service provider or local IPPBX.
Outbound Proxy	Set the IP or FQDN of Outbound proxy server.
SIP User ID	Set the SIP username or telephone number from ITSP.
Authenticate ID	Set the Authenticate ID used by SIP proxy.
TEL URI	Select “User=Phone” or “Enabled” from the dropdown list.
Authenticate Password	Set the Authenticate password used by SIP proxy.

SIP Advanced Settings

This page allows Advanced SIP parameters to be configured.



LiveView

Door System Settings

System Settings

SIP Settings

SIP Basic Settings

SIP Advanced Settings

White List

Video & Audio Settings

Alarm Config

Email & FTP Settings

Maintenance

Status

SIP Advanced Settings

STUN Server	<input type="text"/>
Register Expiration(Minute)	<input type="text" value="3600"/>
Local SIP Port	<input type="text" value="5060"/>
Local RTP Port	<input type="text" value="5004"/>
Auto On-Hook Timer(Second)	<input type="text" value="300"/>
SIP Transport	<input type="text" value="UDP"/>
Stream	<input type="text" value="Stream 2"/>
SIP TLS Certificate	<div style="border: 1px solid #ccc; height: 40px;"></div>
SIP TLS Private Key	<div style="border: 1px solid #ccc; height: 40px;"></div>
SIP TLS Private Key Password	<input type="password" value="•••••"/>
Enable Keep Alive	<input checked="" type="checkbox"/>
Enable Direct IP Call	<input checked="" type="checkbox"/>
SIP Proxy Compatibility Mode	<input type="checkbox"/>
Unregister On Reboot	<input checked="" type="checkbox"/>

Figure 41: SIP Advanced Settings Page

Table 13: SIP Advanced Settings

STUN Server	Enter the STUN server FQDN or IP. If the device is behind a non-symmetric router, STUN server can help to penetrate & resolve NAT issues.
Register Expiration	Set the registration expiration time, default 60 minutes.
Local SIP Port	Set the local SIP port, default 5060.
Local RTP Port	Set the local RTP port for media, default 5004.
Auto On-Hook Timer	Timer (in seconds) for automatic disconnecting the SIP call, default 300.

Ring Timeout(s)	Specifies the Ring timeout, when no reply is returned from the called party after exceeding this filed, the GDS3710 will hang up the call.
SIP Transport	Choose the SIP transport protocol, UDP as default.
Stream	Choose which stream to use for SIP calls. Default 2 nd stream, strongly recommended 2 nd or 3 rd stream due to bandwidth utilization.
SIP TLS Certificate	Copy/Paste the TLS certificate here for encryption.
SIP TLS Private Key	Input private key here for TLS security protection.
SIP TLS Private Key Password	The password for SIP TLS private Key.
Enable Keep Alive	Check to help NAT resolution, sending alive packets.
Accept Direct IP Call	Check to accept peer-to-peer IP call in LAN w/o SIP server.
SIP Proxy Compatibility Mode	Check to enable more proxy compatibility with cost of bandwidth, the SIP call will send both audio and video no matter what.
Unregister on Reboot	If checked and the SIP server support it, reboot the GDS3710 will unbind all registered end points using this SIP account.

White List

This page allows users to configure the white list, which is a phone number or extension list that can call the GDS3710. (the call will be automatically answered when calling from a phone set on the white list).

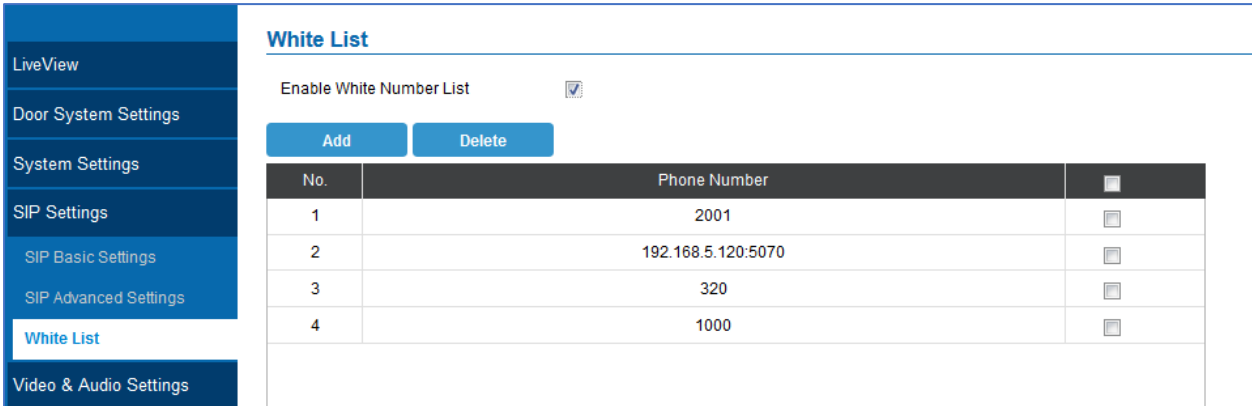

No.	Phone Number	
1	2001	
2	192.168.5.120:5070	
3	320	
4	1000	

Figure 42: White List Page

Table 14: White List

Enable White Number List	Click to enable the White List feature.
Add	Click to add new phone number.
Delete	Click to delete a number from the white list.

Video & Audio Settings

This page allows user to configure the video and audio related settings.

Video Settings

Video Settings	
Stream 1	
Preferred Video Codec	MJPEG
Profile	Main Profile
Resolution	1920*1080(16:9)
Bit Rate(kbps)	4096
Frame Rate(fps)	30
Bit Rate Control	CBR
Image Quality	Normal
I-frame Interval	80
Stream 2	
Preferred Video Codec	H264
Profile	Main Profile
Resolution	640*480(4:3)
Bit Rate(kbps)	512
Frame Rate(fps)	30
Bit Rate Control	CBR
Image Quality	Normal
I-frame Interval	80
Stream 3	
Preferred Video Codec	H264
Profile	Main Profile
Resolution	320*240(4:3)
Bit Rate(kbps)	256
Frame Rate(fps)	30
Bit Rate Control	CBR
Image Quality	Normal
I-frame Interval	80
<input type="button" value="Save"/>	

Figure 43: Video Settings Page



Table 15: Video Settings

Preferred Video Codec (Stream1)	H.264 and MJPEG supported, H.264 recommended.
Profile	H.264 profile pulldown selection among Baseline, Main Profile and High Profile, default is "Main Profile".
Resolution	The resolution in pixels used at video image, 1080p or 720p.
Bit Rate(kbps)	Video bit rate or bandwidth used.
Frame Rate(fps)	Maximum frame rate used (more data if big frame used).
Bit Rate Control	Constantly bit rate, or variable bit rate.
Image Quality	Image quality used when Variable Bit Rate used.
I-frame Interval	I-frame interval (suggested 2~3 times of frame rate).
Preferred Video Codec(Stream2)	H.264 and MJPEG supported, H.264 recommended.
Profile	H.264 profile pulldown selection among Baseline, Main Profile and High Profile, default is "Main Profile".
Resolution	The resolution in pixels used at video image, 480p or 272p.
Bit Rate(kbps)	Video bit rate or bandwidth used.
Frame Rate(fps)	Maximum frame rate used (more data if big frame used).
Bit Rate Control	Constantly bit rate, or variable bit rate.
Image Quality	Image quality used when Variable Bit Rate used.
I-frame Interval	I-frame interval (suggested 2~3 times of frame rate).
Preferred Video Codec(Stream3)	H.264 and MJPEG supported, H.264 recommended.
Profile	H.264 profile pulldown selection among Baseline, Main Profile and High Profile, default is "Main Profile".
Resolution	The resolution in pixels used at video image, 240p.
Bit Rate(kbps)	Video bit rate or bandwidth used.
Frame Rate(fps)	Maximum frame rate used (more data if big frame used).
Bit Rate Control	Constantly bit rate, or variable bit rate.
Image Quality	Image quality used when Variable Bit Rate used.
I-frame Interval	I-frame interval (suggested 2~3 times of frame rate).

Notes:

- H.264 suggested if the GDS3710 needs to be viewed via Internet.



- For definition of Baseline, Main Profile and High profile of H.264 please refer to: [H.264 Profiles](#)
- If MJPEG is selected, reduce the frame rate to the minimal value to save bandwidth and get better image.
- Grandstream GDS3710 provides three video streams, users can use them with flexibility. For example, the high-resolution stream for local recording, another low or high resolution for SIP video phone call or remote smartphone monitoring application, or vice versa depending application scenarios.
- **Use below link to calculate bandwidth and storage before installation**
<http://www.grandstream.com/support/tools/bandwidth-storage-calc>

OSD Settings

OSD Settings (On Screen Display) allow the users to Display time stamp and text on the video screen.

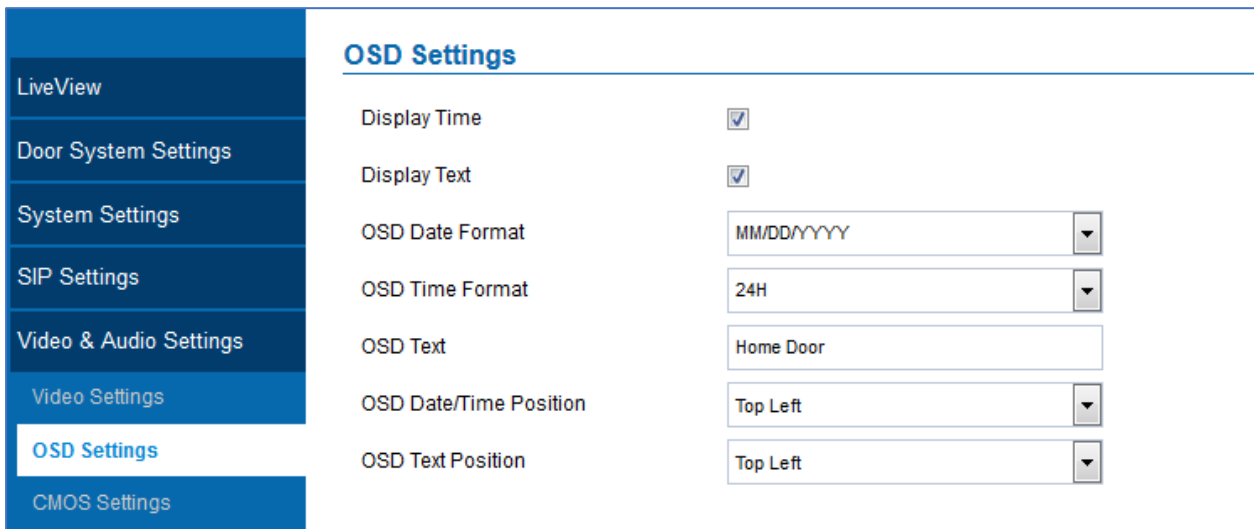

Figure 44: OSD Settings Page

Table 16: OSD Settings

Display Time	When checked, time will be displayed inside the video image.
Display Text	When checked, inputted text on “OSD Test” will be displayed on the video image.
OSD Date Format	OSD Date format, choose based on user preference.
OSD Time Format	OSD Time format, choose based on user preference.
OSD Text	Input a text (to identify the GDS3710) it will be shown on the screen.
OSD Date/Time Position	Show the Date/Time position on the screen.
OSD Text Position	Show the Text position on the screen.

CMOS Settings

This page configures the CMOS parameters for different scenarios.

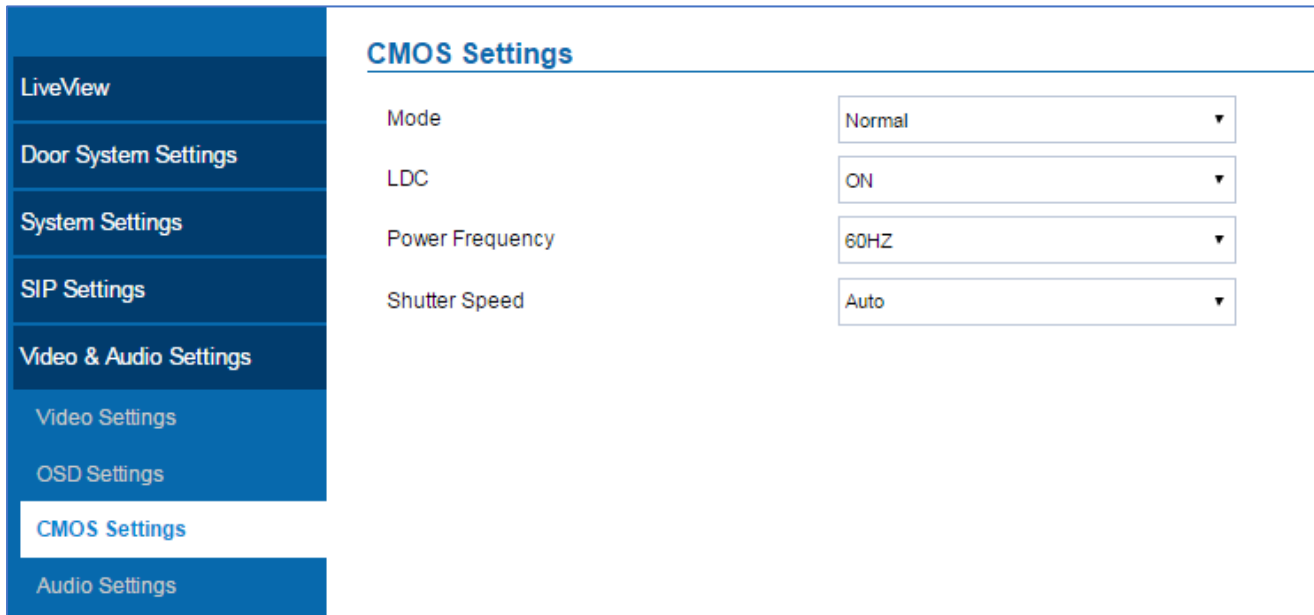

Figure 45: CMOS Settings Page

Table 17: CMOS Settings

Mode	Pull down to choose “Normal, Low Light, WDR” for different light condition. Default “Normal”.
LDC	Default “OFF”. When “ON” the display will take a normal shape, but will lose some details located at corner of the original view.
Power Frequency	Select the frequency power. 50Hz or 60Hz.
Shutter Speed	Defines how much time the shutter of the camera or exposed to the light, when taking a screenshot.

Audio Settings

This page allows users to configure the audio settings.



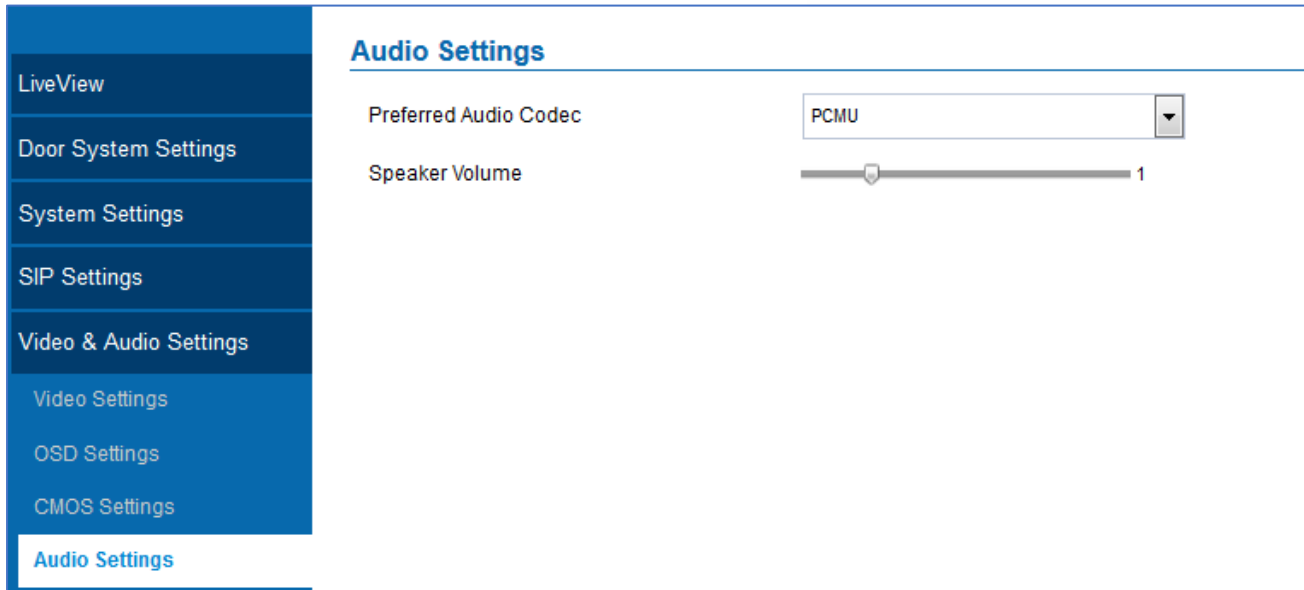

Figure 46: Audio Settings Page

Table 18: Audio Settings

Preferred Audio Codec	PCMU, PCMA and G.722 are supported.
Speaker Volume	Slide to adjust the speaker volume connected.

Alarm Config

This page allows users to configure alarm schedule and alarm actions.

Alarm Events Config

This page allows users to configure GDS3710 events to trigger programmed actions within predefined schedule.

LiveView

Door System Settings

System Settings

SIP Settings

Video & Audio Settings

Alarm Config

Alarm Events Config

Alarm Schedule

Alarm Action

Alarm Phone List

Email & FTP Settings

Maintenance

Status

Alarm Events Config

Motion Detection

Enable Motion Detection Region Config

Sensitivity 50

Select Alarm Schedule All Day ▼

Select Alarm Action Profile profile1 ▼

Digital Input

Digital Input 1 Disable ▼

Select Alarm Schedule 1 All Day ▼

Select Alarm Action Profile 1 profile1 ▼

Digital Input 2 Disable ▼

Select Alarm Schedule 2 All Day ▼

Select Alarm Action Profile 2 profile1 ▼

Digital Output

Alarm Output Duration(s) 5 ▼

Alarm Config

Enable Hostage Code

Enable Tamper Alarm

Enable Keypad Input Error Alarm

Save

Figure 47: Events Page

Alarm can be triggered either by motion detection or by GDS3710 input.



Motion Detection

Users can select a specific region to trigger the alarm using motion detection.

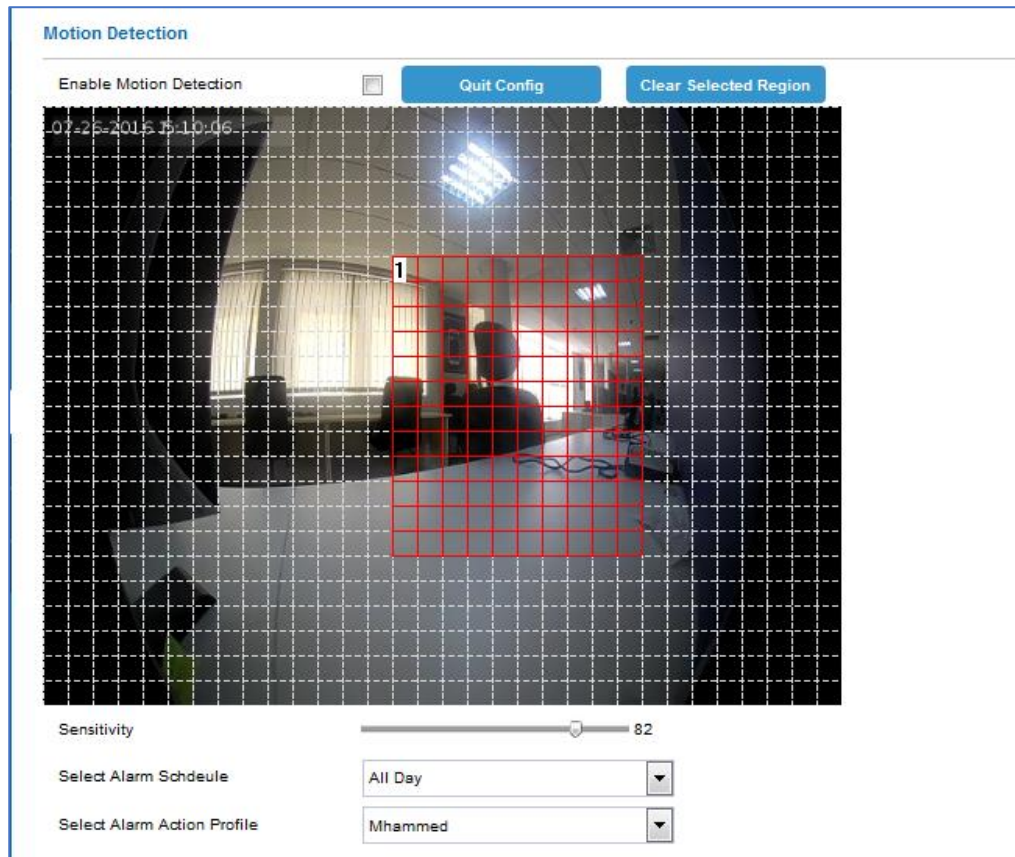

Figure 48: Region Config

Table 19: Motion Detection

Enable Motion Detection	Click on the check box to enable Motion Detection.
Region Config	Click to enter the Region Config menu.
Quit Config	Click to exit the Region Config menu.
Clear Selected Region	Select a zone on the screen then click on Clear to delete the region.
Sensitivity	Region sensitivity (value between 0-100%).
Select Alarm Schedule	Select the Schedule programmed.
Select Alarm Action Profile	Select the programmed Alarm Action.

Digital Input

Digital Input	
Digital Input 1	Alarm Input <input type="button" value="v"/>
Select Alarm Schedule 1	schedule2 <input type="button" value="v"/>
Select Alarm Action Profile 1	profile4 <input type="button" value="v"/>
Digital Input 2	Open Door <input type="button" value="v"/>
Select Alarm Schedule 2	All Day <input type="button" value="v"/>
Select Alarm Action Profile 2	profile1 <input type="button" value="v"/>

Figure 49: Digital Input

Table 20: Digital Input

Digital Input 1	Select the Input method (alarm Input or Door Open).
Select Alarm Schedule 1	Select the predefined Schedule.
Select Alarm Action Profile 1	Select the predefined Alarm Action.
Digital Input 2	Select the Input method (alarm Input or Door Open).
Select Alarm Schedule 2	Select the predefined Schedule.
Select Alarm Action Profile 2	Select the predefined Alarm Action.

Alarm Output

Alarm Output Duration(s) specifies how long the alarm output will take effect. The valid range is 5 to 300 seconds.

Hostage Code

Hostage password can be used in a critical situation for instance a kidnaping or an emergency, users need to enter the following sequence to trigger the actions set for the Hostage Mode:

**** HostagePassword #**".

Table 21: Hostage Code Alarm

Enable Hostage Password	Enable/Disable Hostage password mode.
Hostage Code	Set the password for the hostage mode.
Select Alarm Action Profile	Select the Alarm action to be taken when the hostage password is typed on the GDS3710 keypad. Note: No sound alarm will be triggered in this mode.



Tamper Alarm

Tamper alarm is anti-hack from Hardware level. When this option is checked, if the GDS3710 is removed from the installation board, it will generate the alarm actions configured. There is an embedded mechanism on the GDS3710 that allow it to sense when the it is removed.

Table 22: Tamper Alarm

Enable Tamper Alarm	When activating this mode, GDS3710 will keep alarming until the alarm is dismissed.
Select alarm Action Profile	Select the type of alarms to be taken for the tamper alarm mode.

Keypad Input Error Alarm

Table 23: Keypad Input Error Alarm

Enable Keypad Input Error Alarm	Enable/Disable the Input Error Alarm, GDS3710 will take alarm actions every 5 incorrect attempts.
Select Alarm Profile	Select the Alarm action to be taken after 5 incorrect attempts.

Alarm Schedule

This page specifies the configuration of Alarm Schedule.

Note: Schedule must be configured first to allow the alarm to take the related action.

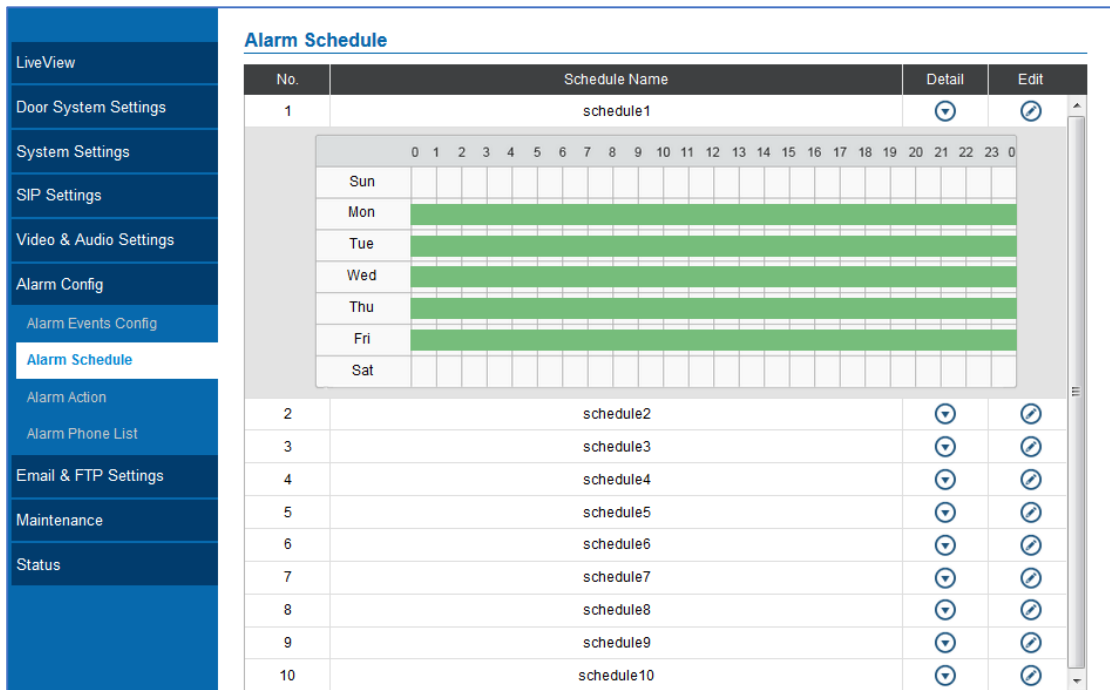

No.	Schedule Name	Detail	Edit
1	schedule1		
2	schedule2		
3	schedule3		
4	schedule4		
5	schedule5		
6	schedule6		
7	schedule7		
8	schedule8		
9	schedule9		
10	schedule10		

Figure 50: Alarm Schedule



GDS3710 supports up to 10 alarm schedules to be configured, with time span specified by users. User can edit the alarm schedule by clicking  button. Usually the 24 hours' span is 00:00 ~ 23:59, which is 24 hours' format.

Users can copy the configuration to different date during the schedule programming.

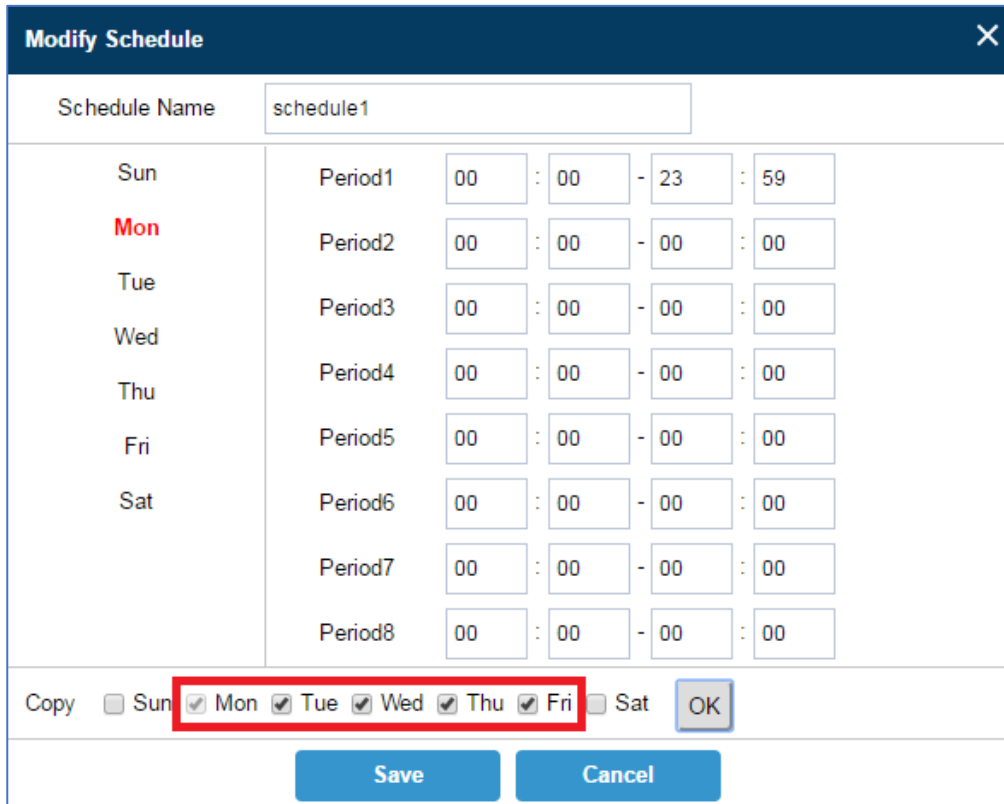

Schedule Name	schedule1				
Sun	Period1	00	: 00	- 23	: 59
Mon	Period2	00	: 00	- 00	: 00
Tue	Period3	00	: 00	- 00	: 00
Wed	Period4	00	: 00	- 00	: 00
Thu	Period5	00	: 00	- 00	: 00
Fri	Period6	00	: 00	- 00	: 00
Sat	Period7	00	: 00	- 00	: 00
	Period8	00	: 00	- 00	: 00

Copy Sun **Mon** **Tue** **Wed** **Thu** **Fri** Sat

Figure 51: Edit Schedule

Alarm Action

This page specifies the configuration of Profile used by the Alarm Actions. A Profile is required before the Alarm Action can take effect.

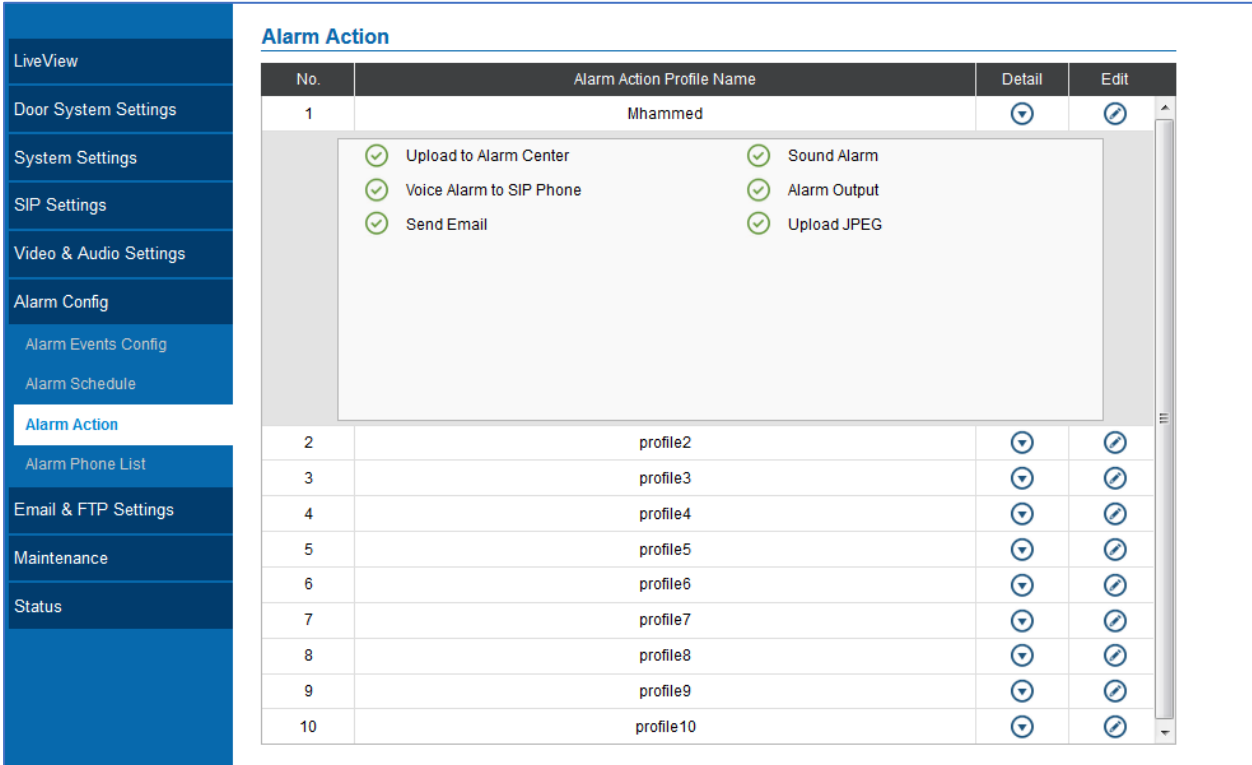

Alarm Action

No.	Alarm Action Profile Name	Detail	Edit
1	Mhammed		
<div style="display: flex; flex-wrap: wrap;"> <div style="width: 50%;"><input checked="" type="checkbox"/> Upload to Alarm Center</div> <div style="width: 50%;"><input checked="" type="checkbox"/> Sound Alarm</div> <div style="width: 50%;"><input checked="" type="checkbox"/> Voice Alarm to SIP Phone</div> <div style="width: 50%;"><input checked="" type="checkbox"/> Alarm Output</div> <div style="width: 50%;"><input checked="" type="checkbox"/> Send Email</div> <div style="width: 50%;"><input checked="" type="checkbox"/> Upload JPEG</div> </div>			
2	profile2		
3	profile3		
4	profile4		
5	profile5		
6	profile6		
7	profile7		
8	profile8		
9	profile9		
10	profile10		

Figure 52: Alarm Action

User can edit the alarm action by clicking  button, the following window will popup.

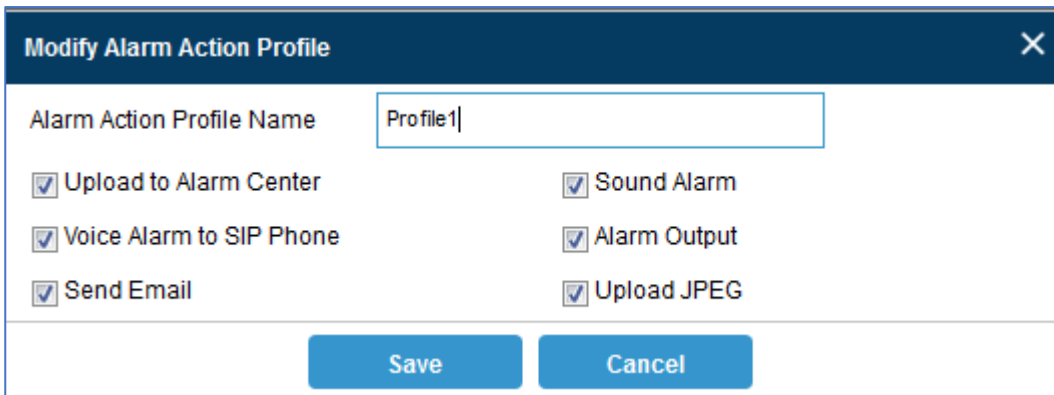

Modify Alarm Action Profile ✕

Alarm Action Profile Name

Upload to Alarm Center

Sound Alarm

Voice Alarm to SIP Phone

Alarm Output

Send Email

Upload JPEG

Save
Cancel

Figure 53: Edit Alarm Action

Table 24: Alarm Actions

Upload to Alarm Center	When checked, the alarm video will be transferred to Alarm Center.
Voice Alarm to SIP Phone	If the SIP server or the peer IP device is configured, check this will allow the event to trigger alarm SIP call to pre-configured number.
Send Email	When checked, an email will be sent when the events are triggered to the pre-configured email account.

Sound Alarm	When selected, alarm will be played from the GDS3710 Built-in Speaker.
Alarm Output	An alarm will be sent to the Alarm Output interface if this option is checked.
Upload JPEG	When checked, snapshots of the moment where the event is triggered will be uploaded to the FTP server.

Alarm Phone List

This page allows users to configure the Alarm Phone List, which are phone numbers or extensions list that the GDS3710 will call out when event is triggered (e.g.: doorbell pressed).

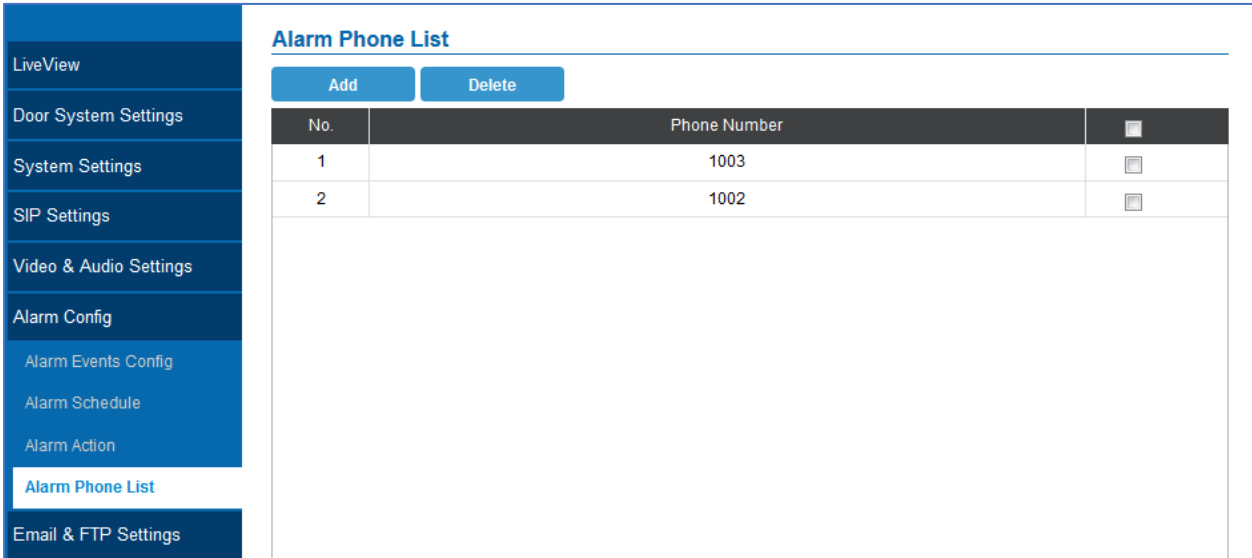

Alarm Phone List		
No.	Phone Number	<input type="checkbox"/>
1	1003	<input type="checkbox"/>
2	1002	<input type="checkbox"/>

Figure 54: Alarm Phone List

Table 25: Alarm Phone List

Add	Add new phone number to the alarm list.
Delete	Delete a number from the phone alarm list.

Once the event is triggered (Motion Detection, Door Bell Pressed...), the GDS3710 will call the first number, once time out is reached and no answer is returned from the first number, the GDS3710 will try the next number on the list and so on. Once the remote phone answers the call, an alarm will be played to notify users that an event is triggered.

Email & FTP Settings

This page contains Email and FTP Settings.

Email Settings

This page allows users to configure email client to send out an email when the alarm is triggered.

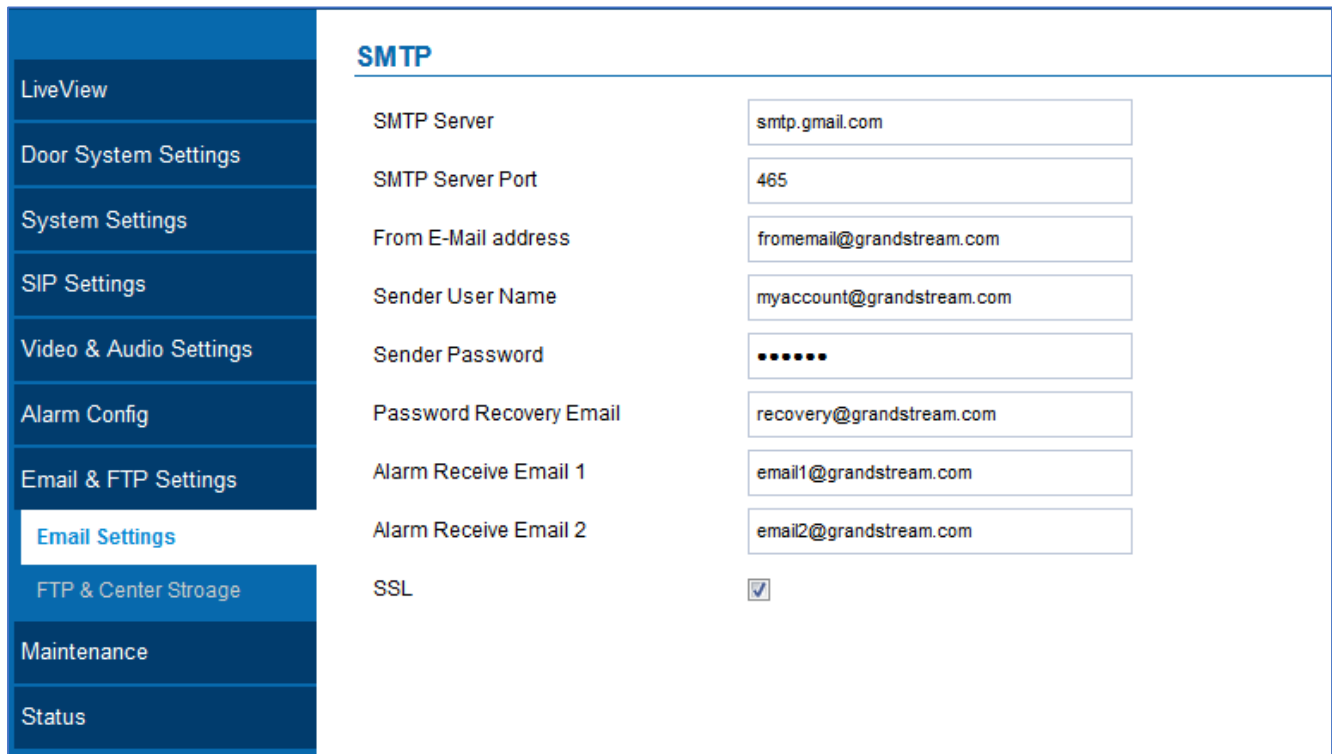

Figure 55: Email Settings - SMTP Page

Table 26: Email Settings - SMTP

SMTP Server	SMTP Email Server IP or Domain Name.
SMTP Server Port	Port number used by server to send email.
From E-mail address	The email address of alarm email sending from, usually client email ID.
Sender User Name	Sender's User ID or account ID in the email system used.
Sender Password	Sender's password of the email account.
Password Recovery Email	Email address used when password forgot and reset required.
Alarm Receive Email 1	The 1 st email address to receive the alarm email.
Alarm Receive Email 2	The 2 nd email address to receive the alarm email.
SSL	Check if the SMTP email server requires SSL.

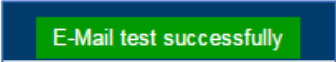

Notes:

- Click “Save” to save the email configuration information.
 - Click “Email Test” after configuration, if settings are correct, a test email will send out and “E-mail test successfully” message on the top page will appear 

FTP & Center Storage

This page allows users to configure the FTP Settings in order to upload capture images.

Table 27: FTP

Enable Picture Storage	Check to Enable the Picture Storage.
Storage Server Type	Select whether to upload pictures to the GDS Manager or upload them to the FTP server.
FTP Server	Enter the IP address of the FTP server when selected to upload images to.
FTP Server Port	Enter FTP address port.
FTP User Name	Enter the FTP server account name.
FTP Password	Enter the FTP server password.
FTP Path	Select the Storage path.
FTP Test	Click in order to test if the connection with FTP server.

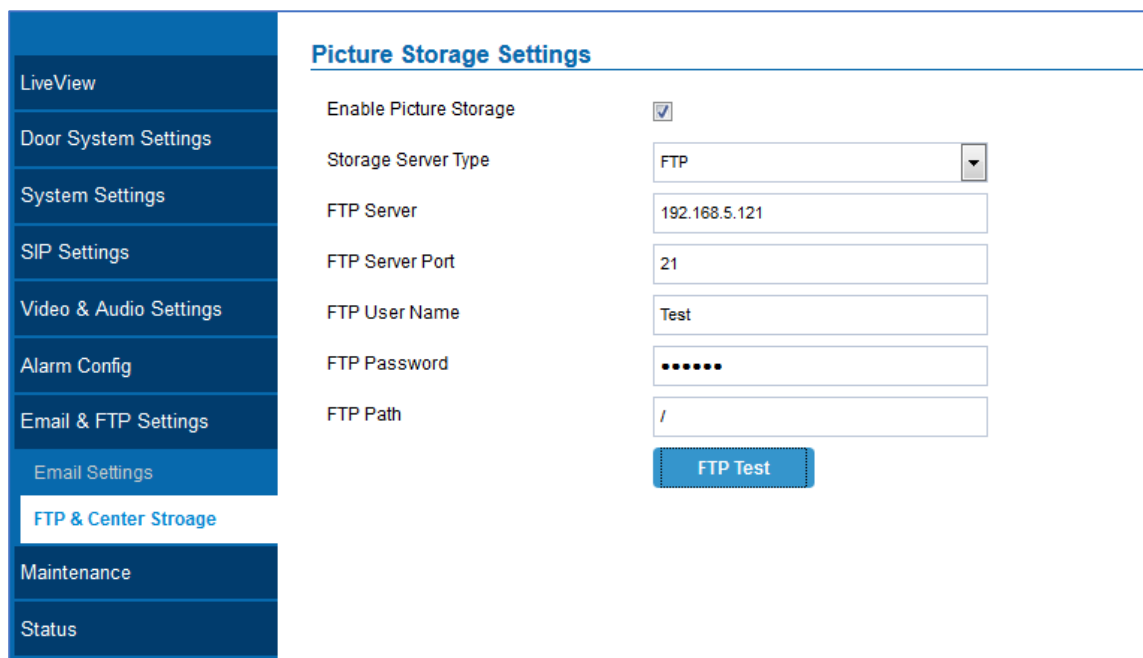

Figure 56: Picture Storage Settings



Note: If the connection to the FTP server is successful, a “.txt” file containing a success message will be uploaded to the FTP server. And the following message will pop up on the webGUI



Maintenance Settings

This page shows the GDS3710 Maintenance parameters.

Upgrade

This page contains the upgrade parameters of the GDS3710.

Upgrade	
Upgrade Via	HTTP
Firmware Server Path	fm.grandstream.com/gs
Config Server Path	fm.grandstream.com/gs
XML Config File Password
Automatic Upgrade Interval(m)	10080
DHCP Option 66 Override Server	<input type="checkbox"/>
Zero Config	<input type="checkbox"/>
Automatic Upgrade	<input checked="" type="checkbox"/>

Figure 57: Upgrade Page

Table 28: Upgrade

Upgrade Via	Select the Upgrade method (TFTP, HTTP, HTTPS).
Firmware Server Path	Set the IP address or the FQDN of the upgrade server.
Config Server Path	Set the IP address or the FQDN of the configuration server.
XML Config file Password	Set the password for the configuration file.
Automatic Upgrade Interval	Set the upgrade interval in minutes.



DHCP Option 66 Override Server	Check to activate DHCP option 66 to override upgrade/config servers.
Zero Config	Check to activate auto provisioning.
Upgrade Via	Select the Upgrade method (TFTP, HTTP, HTTPS).

Reboot & Reset

This page allows user to reboot and reset the GDS3710.

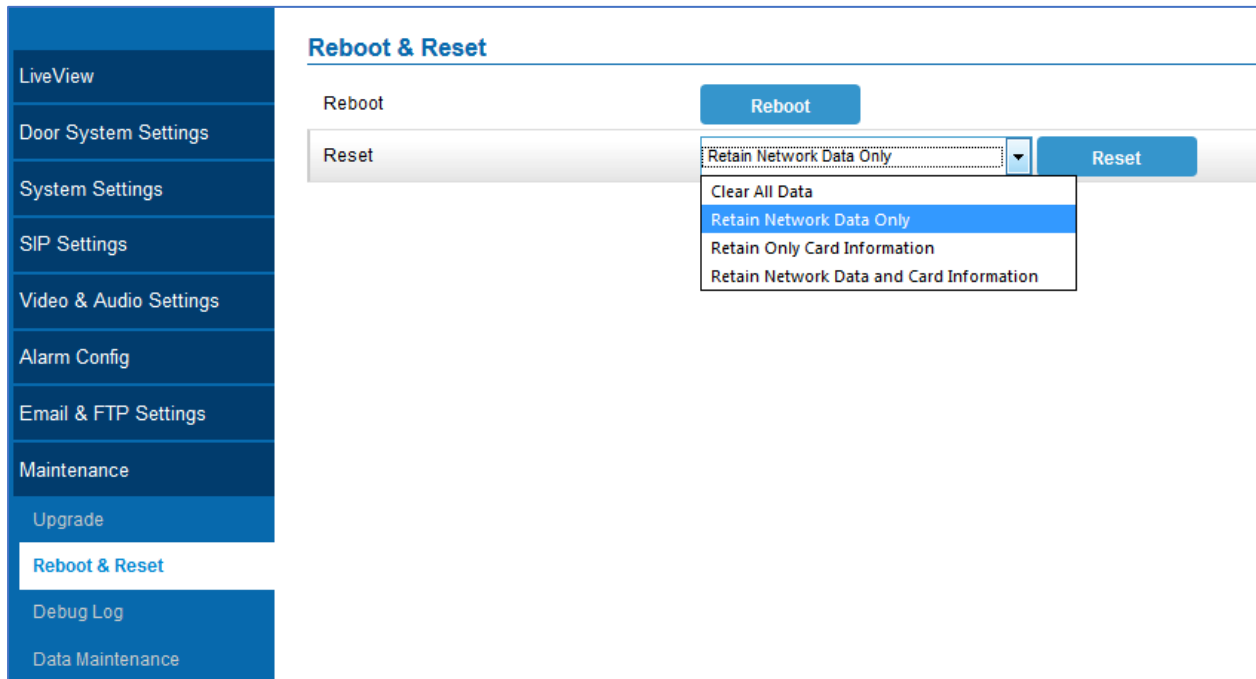

Figure 58: Reset & Reboot Page

Table 29: Reset & Reboot

Reboot	When clicked, the GDS3710 will restart (soft reboot).
Reset	There are two options for the reset function.
Clear All Data	All data will be reset, GDS3710 will be set to factory default.
Retain Network Data Only	All data will be erased except for Network data like IP address...
Retain Only Card Information	All data will be erased except for cards information.
Retain Network Data and Card Information	All data will be erased except for Network Data and Card Information.

Debug Log

This page allows user to configure SYSLOG to collect information to help troubleshooting issues with GDS3710.



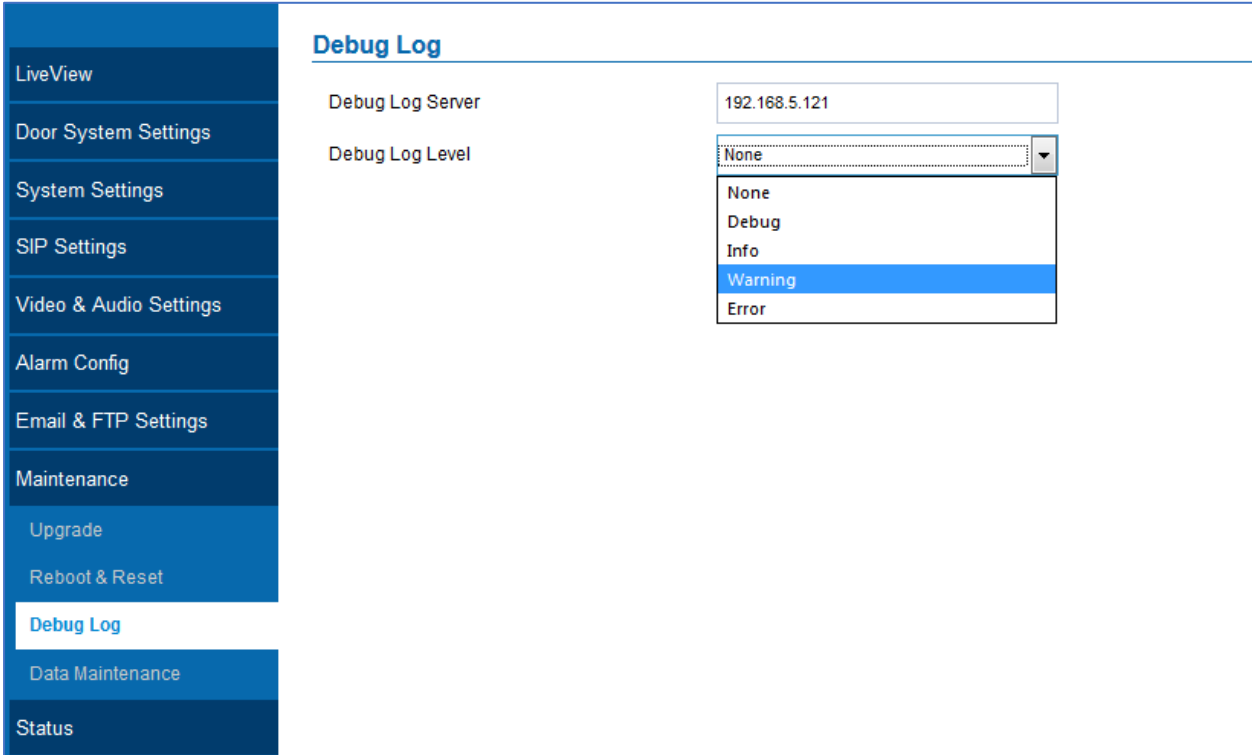

Debug Log

Debug Log Server: 192.168.5.121

Debug Log Level: **Warning**

Figure 59: Debug Log Page

Notes:

- Five levels of Debugging are available, None, Debug, Info, Warning, Error.
- Once the Syslog Server and the level entered, press “Save” and then Reboot the GDS3710 to apply the settings.

Data Maintenance

This page allows user to save the GDS3710 configuration file.

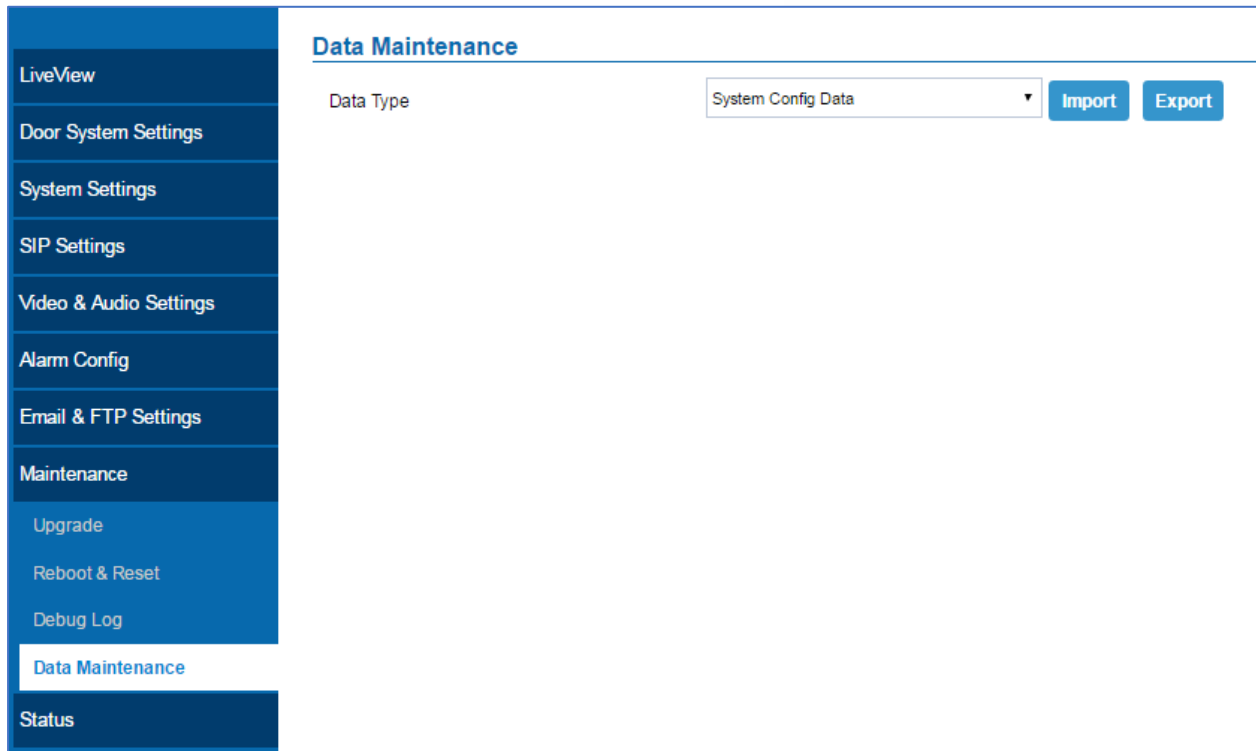

Figure 60: Data Maintenance Page

Click on **Export** in order to save the GDS3710 configuration in a predefined directory.

Status

This page displays GDS3710 system and network information.

System Info

This page displays information such as the product model, the hardware version, firmware...

LiveView	<h3 style="margin: 0;">System Info</h3> <table style="width: 100%; border-collapse: collapse;"> <tr> <td style="width: 30%;">Product Model</td> <td>GDS3710</td> </tr> <tr> <td>Hardware Version</td> <td>V1.3A</td> </tr> <tr> <td>Part Number</td> <td>9650001413A</td> </tr> <tr> <td>Kernel Version</td> <td>1.0.1.19</td> </tr> <tr> <td>RootFS Version</td> <td>1.0.1.19</td> </tr> <tr> <td>Prog Version</td> <td>1.0.1.19</td> </tr> <tr> <td>System Up Time Since</td> <td>3 hours 1 minute</td> </tr> <tr> <td>SIP Registered</td> <td style="text-align: center;">Online</td> </tr> </table>	Product Model	GDS3710	Hardware Version	V1.3A	Part Number	9650001413A	Kernel Version	1.0.1.19	RootFS Version	1.0.1.19	Prog Version	1.0.1.19	System Up Time Since	3 hours 1 minute	SIP Registered	Online
Product Model		GDS3710															
Hardware Version		V1.3A															
Part Number		9650001413A															
Kernel Version		1.0.1.19															
RootFS Version		1.0.1.19															
Prog Version		1.0.1.19															
System Up Time Since		3 hours 1 minute															
SIP Registered		Online															
Door System Settings																	
System Settings																	
SIP Settings																	
Video & Audio Settings																	
Alarm Config																	
Email & FTP Settings																	
Maintenance																	
Status																	
System Info																	
Network Info																	

Figure 61: System Info Page

Table 30: System Info

Product Model	Show the Product Model.
Hardware Version	Show the Hardware Version.
Part Number	Show the Part Number.
Kernel Version	Show the Kernel Version.
RootFS Version	Show the RootFS Version.
Prog Version	Show the Prog Version.
System Up Time Since	Show the time since the first boot of the GDS3710.

Notes:

- When the SIP account is registered, the status display will be Online
- When SIP account is unregistered, the status display will be Offline

Network Info

This page displays the network system information of GDS3710.



LiveView	System Info	
Door System Settings	MAC Address	00:0B:82:6F:92:55
System Settings	IP Address Mode	DHCP
SIP Settings	IP Address	192.168.5.119
Video & Audio Settings	Subnet Mask	255.255.255.0
Alarm Config	Gateway	192.168.5.1
Email & FTP Settings	DNS Server 1	8.8.8.8
Maintenance	DNS Server 2	8.8.4.4
Status		
System Info		
Network Info		

Figure 62: Network Info Page

Table 31: Network Info

MAC Address	Display the GDS3710 MAC Address.
IP Address Mode	Displays the IP address mode used.
IP Address	Display the IP address of the GDS3710.
Subnet Mask	Display the Subnet Mask used.
Gateway	Display the GDS3710 Gateway.
DNS Server 1	Display the Preferred DNS Server.
DNS Server 2	Display the secondary DNS Server.

EXPERIENCING THE GDS3710

Please visit our website: <http://www.grandstream.com> to receive the most up-to-date updates on firmware releases, additional features, FAQs, documentation and news on new products.

We encourage you to browse our [product related documentation](#), [FAQs](#) and [User and Developer Forum](#) for answers to your general questions. If you have purchased our products through a Grandstream Certified Partner or Reseller, please contact them directly for immediate support.

Our technical support staff is trained and ready to answer all of your questions. Contact a technical support member or [submit a trouble ticket online](#) to receive in-depth support.

Thank you again for purchasing Grandstream Door Phone System, it will be sure to bring convenience and color to both your business and personal life.

