

As shown below:

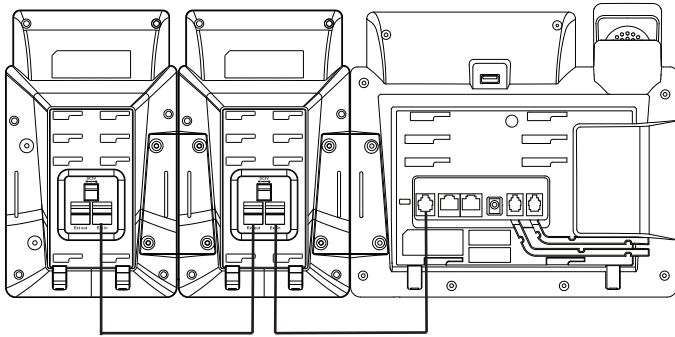

Connecting Cord

**Note:** You can connect six modules at most. You just need to connect the Ext in jack of the previous module and the Ext out jack of the next module using a connecting cord.

Then you can attach the stand, the power adapter and the Ethernet cable to the phone, connect the handset and headset to use.

### Assembling the EXP40

Attach the stand or the optional wall mount bracket, as shown below:

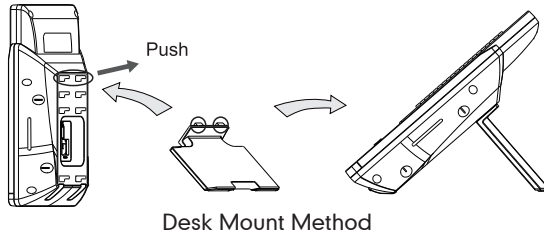

Desk Mount Method

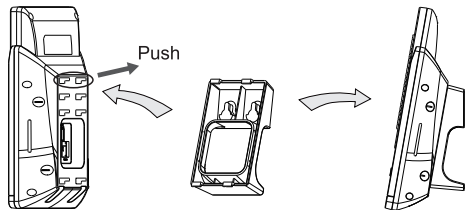

Wall Mount Method(Optional)

**Note:** Yealink provides the wall mount drilling template, which locates and marks the position for the mounting screws on the wall. You can download it at: <http://www.yealink.com/Support.aspx>.

For more information, refer to the User Guide online at <http://www.yealink.com/DocumentDownload.aspx?CatId=142&flag=142>  
Copyright © 2013 YEALINK NETWORK TECHNOLOGY CO.,LTD.

**Yealink**  
EASY VOIP

# Expansion Module EXP40

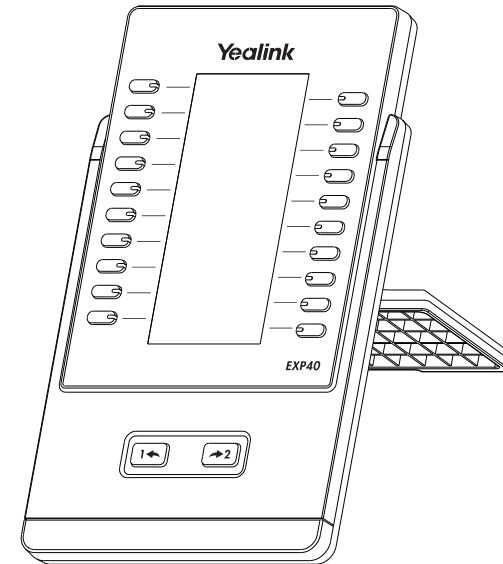

**Quick Installation Guide**



[www.yealink.com](http://www.yealink.com)

## Packaging Contents

The following items are included in your package. If you find anything missing, contact your system administrator.

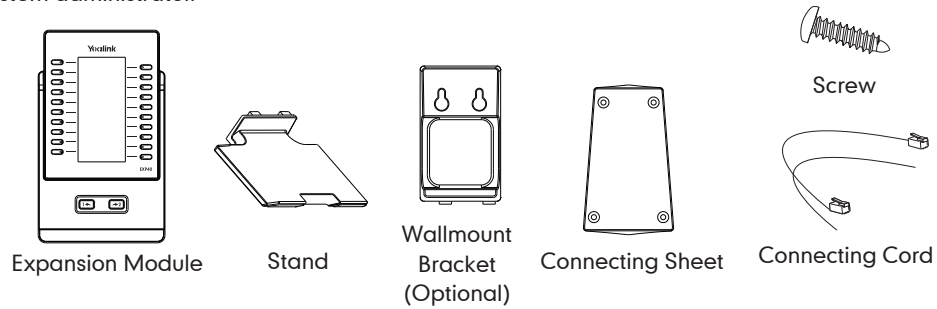

## Connecting to the Phone

1. Connect the EXP40 and the phone using the supplied screws and connecting sheet, as shown below:

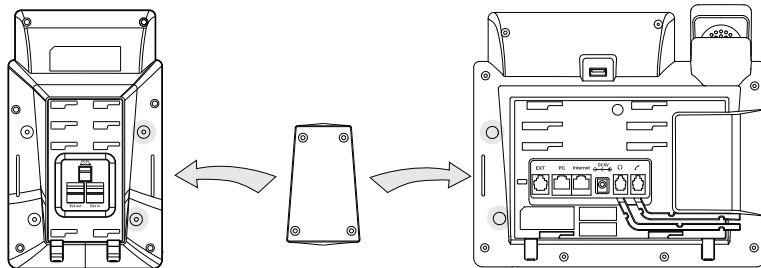

Your phone and the expansion module will be connected as shown below:

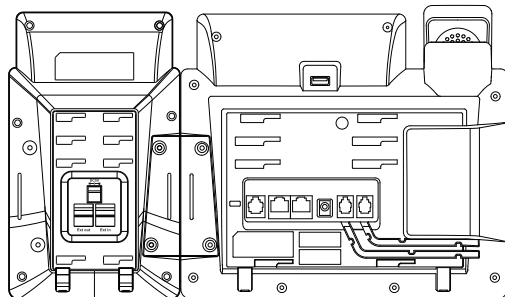

## Connecting to two Modules

2. Follow the same step to connect two expansion modules:

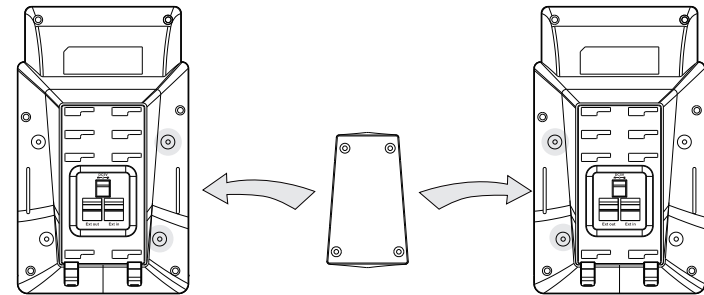

Your phone and the two expansion modules will be connected as shown below:

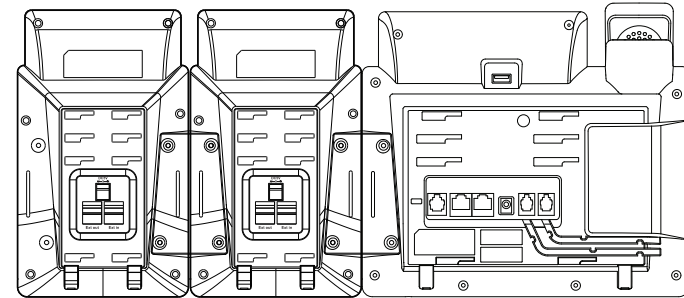

**Note:** The T46G IP phone can support six expansion modules at most. But if you use more than two expansion modules, you need to connect an additional power adapter to any one of the expansion modules.

## Connecting the Cords

3. Connect the Ext jack of the IP phone and the Ext in jack of the first module using a connecting cord. If you want to connect another module, connect the Ext out jack of the first module and the Ext in jack of the second module using a connecting cord.